

GEWINDEDREHEN THREAD TURNING
GEWINDEFRÄSEN THREAD MILLING



VHM
SCHWARZ

Zerspanungswerkzeuge



Unsere Leistungen bestehen aus Planung, Konstruktion, 3D-Simulation, Herstellung und Qualitätskontrolle von Präzisionswerkzeugen.

Wir sind spezialisiert auf HPC-Fräser und HPC-Bohrer. Gerne verwirklichen wir Ihnen auch spezielle Anfertigungen von Präzisionswerkzeugen.

Our services consist of planning, construction, 3D-simulation, manufacturing and quality control of high precision tools.

We are specialized in HPC Endmills and HPC Drills. We are also happy to realize any wishes for special tools.



In unserem hochmodernen Maschinenpark benutzen wir ausschließlich CNC-Schleifzentren der neusten Generation, von namhaften Herstellern wie Walter und Saake. Durch Messmaschinen der Firma Zoller, sind wir in der Lage, Ihre Bedürfnisse von Präzisions- und Sonderwerkzeugen so schnell wie möglich zu realisieren.

In our machine park, we exclusively use CNC grinding centers of the latest generation from well-known manufacturers such as Walter and Saake.

Due to our measuring machines from Zoller, we are able to realize your needs of precision and special tools as quickly as possible.

SCHWARZ

SCHWARZ ist ein Hersteller von hochpräzisen und langlebigen Zerspanungswerkzeugen. Namhafte Unternehmen der Automobilbranche sowie Unternehmen aus der Luft- und Raumfahrttechnik zählen zu unseren Kunden. Wir möchten Ihnen unsere Qualität und Technologie näher bringen und stehen Ihnen gerne auch bei der Auswahl und Verwendung unserer Werkzeuge mit Rat und Tat zur Seite.

Unsere Werkzeuge werden nach DIN ISO 9001:2008 gefertigt und erfüllen somit alle Industriestandards. Wir entwickeln sie stetig weiter, damit wir unsere Kunden mit zeitgemäßen Arbeitsmitteln ausstatten können.

SCHWARZ garantiert Ihnen ausgezeichnete Qualität und hohe Standzeiten. Mit dem Kauf unserer Werkzeuge leisten Sie außerdem einen wertvollen Beitrag zum Schutz unserer Umwelt, da wir bei der Herstellung ausschließlich grüne und saubere Technologien einsetzen.

Wir freuen uns darauf, demnächst auch Sie von unserer Kompetenz überzeugen zu dürfen!

***SCHWARZ** is a producer of high-precision and long-lasting cutting tools. Among our customers, there are well-known companies from the automotive industry as well as such from the aerospace branch. We would like to present our quality and technology to you by providing technical support from the choice to the usage of our tools.*

Our tools are produced in accordance with DIN ISO 9001:2008 and thereby all the industry standards are fulfilled. Furthermore, they are always in development enabling us to meet our customer's contemporary needs.

***SCHWARZ** guarantees you excellent quality and very high durability. Buying our tools also means to protect our environment through the exclusive use of clean and green technologies during the production process.*

We look forward to an opportunity to convince you of our competence, too!

© Urheberrechtlich geschützt. Nachdruck, auch auszugsweise, nur mit unserer Genehmigung. Änderungen vorbehalten. Mit diesem Katalog werden alle vorherigen Ausgaben ungültig.

© Copyright. No part of this instruction manual may be reproduced without our permission. Subject to changes. The editions supersedes all the earlier editions.

GEWINDEDREHEN <i>THREAD TURNING</i>	3
Gewindedrehplatten Thread Turning Inserts	5
Gewindedrehhalter Thread Turning Toolholders	65
Gewindedrehen technischer Teil Thread Turning Technical Section	75
Stechplatten Grooving Inserts	87
Miniaturlwerkzeuge Tiny Tools	91
Gewindewirbelwerkzeuge Thread Whirling	139
GEWINDEFÄSEN <i>THREAD MILLING</i>	141
Gewindefräsplatten Thread Milling Inserts	143
Gewindefräshalter Thread Milling Toolholders	153
VHM-Gewindefräser Solid Carbide Thread Mills	159
Mini-Gewindefräser Mini Thread Mills	179
Mini-Gewindefräser für gehärtete Materialien Mini Thread Mills for hardened Steel	195
Gewindefräsen Technischer Teil Thread Milling Technical Section	201
Mini Senk-Werkzeuge Mini Chamfering Tools	210
Lehringe/Lehrdorne Ring Gauges/Plug Gauges	213



THREAD ⚡ ***TURNING***





1

GEWINDEDREHPLATTEN

THREAD TURNING INSERTS

THREAD TURNING

PRODUKT BEZEICHNUNG | PRODUCT DESIGNATION

BEISPIEL | EXAMPLE: 3ER12UN

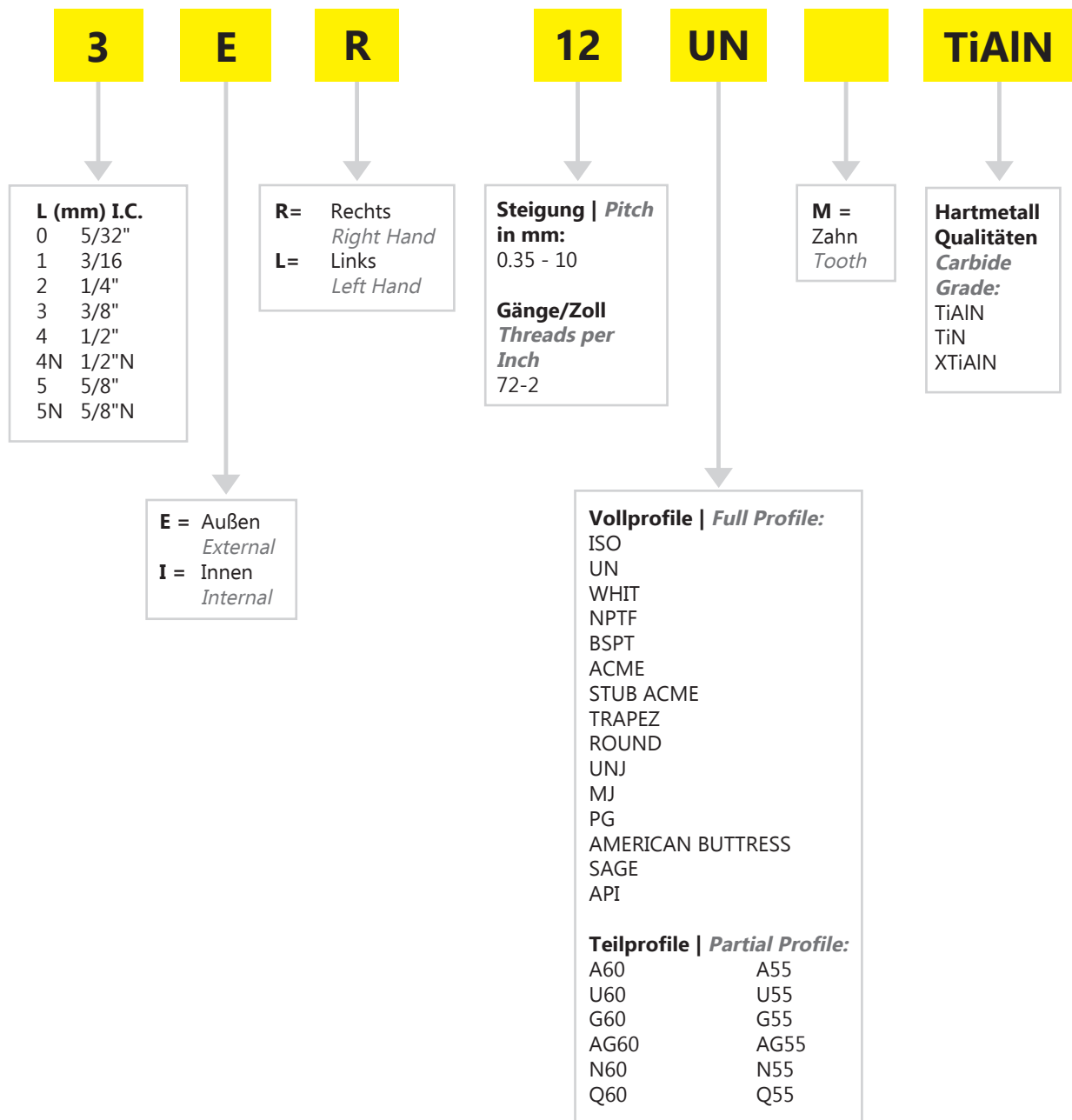

TEILPROFIL 60° / PARTIAL PROFILE 60°

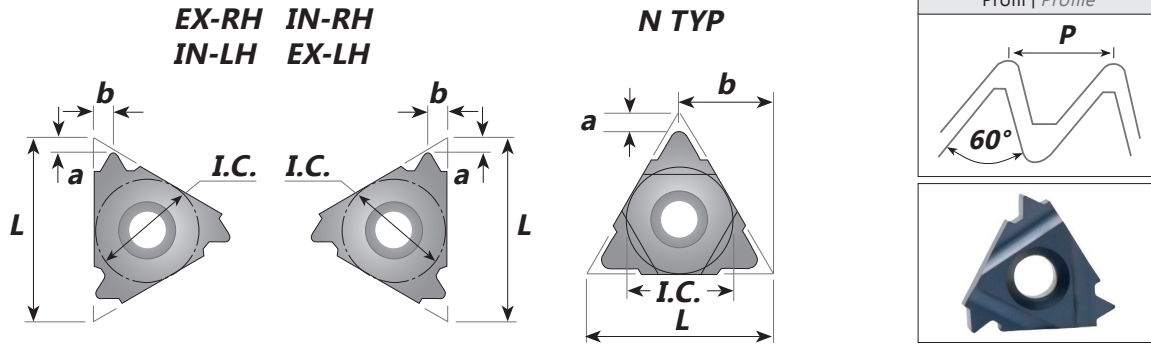

Artikelnummer (Item Number)	Steigung (Pitch)		Länge (Length) L	Maße in mm (Dimensions in mm)	
	mm	Gänge/Zoll (TPI)		a	b
0IRA60	0.5	48	6	0.6	0.6
0ILA60	-	-			
1IRA60	1.25	20	8	0.6	0.7
1ILA60	0.5	48			
2ERA60	-	-	11	0.8	0.9
2IRA60	1.5	16			
2ELA60	0.5	48			
2ILA60	-	-	16	0.8	0.9
3ERA60	1.5	16			
3IRA60	0.5	48			
3ELA60	-	-	16	1.2	1.7
3ILA60	1.75	14			
3IRG60	3.0	8			
3ELG60	-	-			
3ILG60					

ER = Außen Rechts | *External Right* IR = Innen Rechts | *Internal Right* EL = Außen Links | *External Left* IL = Innen Links | *Internal Left*
 EL und IL auf Anfrage | *EL and IL upon Request*

Für kleine Bohrungen siehe Seite 110-111 | *For small bore threading see page 110-111*

Hartmetallqualitäten und Schnittgeschwindigkeiten siehe Seite 76-77 | *For Carbide Grades and Cutting Speed see page 76-77*

TEILPROFIL 60° / PARTIAL PROFILE 60°

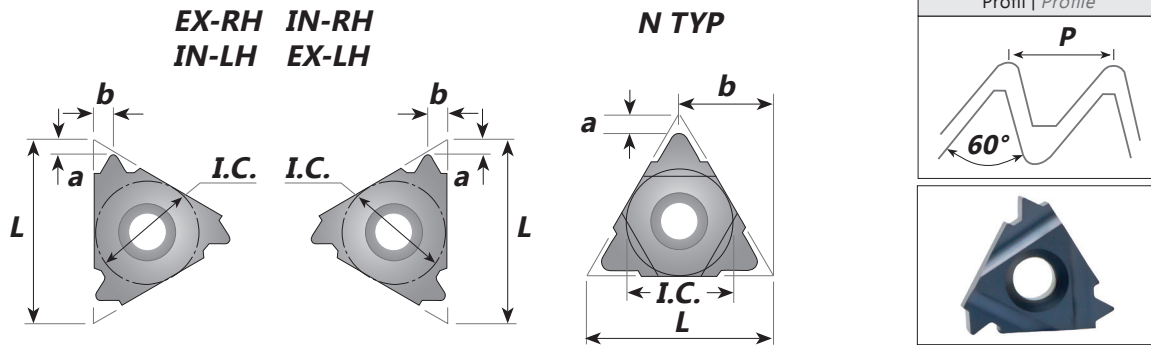

Artikelnummer (Item Number)	Steigung (Pitch)		Länge (Length) L	Maße in mm (Dimensions in mm)	
	mm	Gänge/Zoll (TPI)		a	b
3ERAG60	0.5 - 3.0	48 - 8	16	1.2	1.7
3IRAG60					
3ELAG60					
3ILAG60					
4ERN60	3.5 - 5.0	7 - 5	22	1.7	2.5
4IRN60					
4ELN60					
4ILN60					
5ERQ60	5.5 - 6.0	4.5 - 2.75	27	2.1	3.1
5ELQ60					
5IRQ60					
5ILQ60					

ER = Außen Rechts | *External Right* IR = Innen Rechts | *Internal Right* EL = Außen Links | *External Left* IL = Innen Links | *Internal Left*
 EL und IL auf Anfrage | *EL and IL upon Request*

TEILPROFIL 60° / PARTIAL PROFILE 60° VERTIKAL / VERTICAL

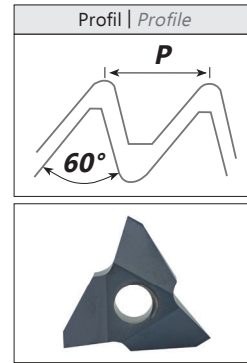
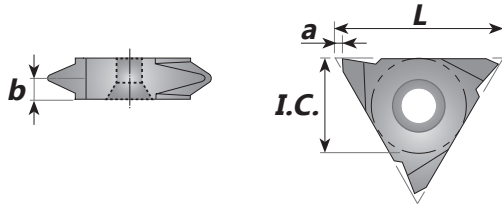

Artikelnummer (Item Number)	Steigung (Pitch)		Länge (Length) L	Maße in mm (Dimensions in mm)	
	mm	Gänge/Zoll (TPI)		a	b
3VERA60	0.5	48	16	1.0	0.9
3VELA60	-	-			
3VERG60	1.5	16	16	1.0	1.8
3VELG60	-	-			
3VERAG60	1.75	14	16	1.0	1.8
3VELAG60	-	-			
3VERAG60	0.5	48	16	1.0	1.8
3VELAG60	-	-			
3VELAG60	3.0	8			

ER = Außen Rechts | External Right
EL auf Anfrage | EL upon Request

EL = Außen Links | External Left

TEILPROFIL 55° / PARTIAL PROFILE 55°

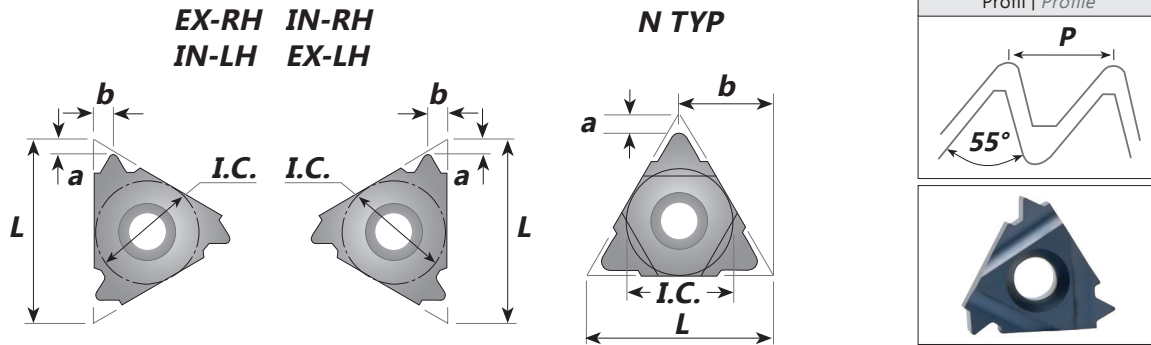

Artikelnummer (Item Number)	Steigung (Pitch)		Länge (Length) L	Maße in mm (Dimensions in mm)	
	mm	Gänge/Zoll (TPI)		a	b
0IRA55	0.5	48	6	0.5	0.6
0ILA55	-	-			
1IRA55	1.25	20	8	0.6	0.7
1ILA55	-	-			
2ERA55	0.5	48	11	0.8	0.9
2IRA55	-	-			
2ELA55	1.5	16			
2ILA55	-	-			
3ERA55	0.5	48	16	0.8	0.9
3IRA55	-	-			
3ELA55	1.5	16			
3ILA55	-	-			
3ERG55	1.75	14	16	1.2	1.7
3IRG55	-	-			
3ELG55	3.0	8			
3ILG55	-	-			

ER = Außen Rechts | External Right IR = Innen Rechts | Internal Right EL = Außen Links | External Left IL = Innen Links | Internal Left
 EL und IL auf Anfrage | EL and IL upon Request

Für kleine Bohrungen siehe Seite 110-111 | For small bore threading see page 110-111
 Hartmetallqualitäten und Schnittgeschwindigkeiten siehe Seite 76-77 | For Carbide Grades and Cutting Speed see page 76-77

TEILPROFIL 55° / PARTIAL PROFILE 55°

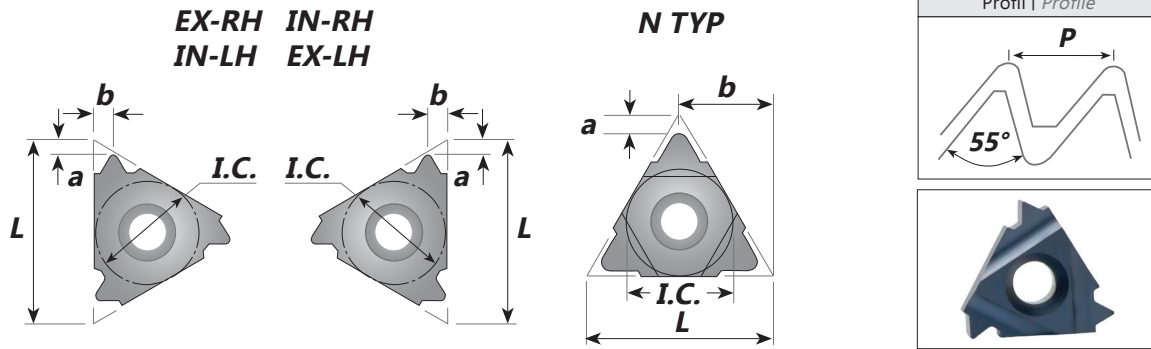

Artikelnummer (Item Number)	Steigung (Pitch)		Länge (Length) L	Maße in mm (Dimensions in mm)	
	mm	Gänge/Zoll (TPI)		a	b
3ERAG55	0.5 - 3.0	48 - 8	16	1.2	1.7
3IRAG55					
3ELAG55					
3ILAG55					
4ERN55	3.5 - 5.0	7 - 5	22	1.7	2.5
4IRN55					
4ELN55					
4ILN55					
5ERQ55	5.5 - 6.0	4.5 - 4	27	2.0	2.9
5ELQ55					
5IRQ55					
5ILQ55					

ER = Außen Rechts | *External Right*
EL und IL auf Anfrage | *EL and IL upon Request*

IR = Innen Rechts | *Internal Right*

EL = Außen Links | *External Left*

IL = Innen Links | *Internal Left*

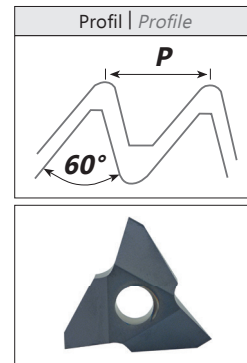
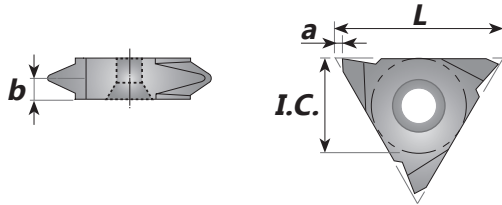
**TEILPROFIL 55° / PARTIAL PROFILE 55°
VERTIKAL / VERTICAL**

Artikelnummer (Item Number)	Steigung (Pitch)		Länge (Length) L	Maße in mm (Dimensions in mm)	
	mm	Gänge/Zoll (TPI)		a	b
3VERA55	0.5	48	16	1.0	0.9
3VELA55	-	-			
3VERAG55	1.5	16	16	1.0	1.8
3VELAG55	-	-			
3VERG55	0.5	48	16	1.0	1.7
3VELG55	-	-			
	3.0	8			
	1.75	14			
	-	-			
	3.0	8			

ER = Außen Rechts | *External Right* IR = Innen Rechts | *Internal Right* EL = Außen Links | *External Left* IL = Innen Links | *Internal Left*
 EL und IL auf Anfrage | *EL and IL upon Request*

ISO-METRISCH / ISO-METRIC

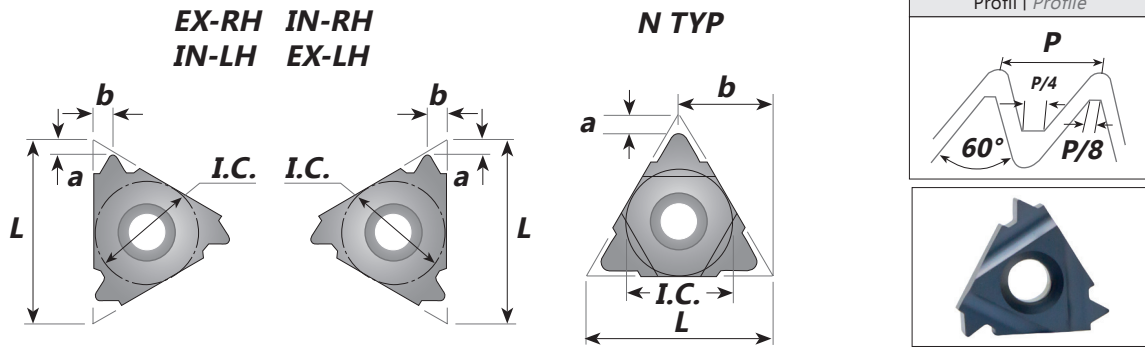

Artikelnummer (Item Number)	Steigung (Pitch) mm	Länge (Length) L	Maße in mm (Dimensions in mm)	
			a	b
OIR0.5ISO	0.5	6	0.9	0.5
OIL0.5ISO				
OIR0.75ISO	0.75	6	0.8	0.5
OIL0.75ISO				
OIR1.0ISO	1.0	6	0.7	0.6
OIL1.0ISO				
OIR1.25ISO	1.25	6	0.6	0.6
OIL1.25ISO				
1IR0.5ISO	0.5	8	0.6	0.5
1IL0.5ISO				
1IR0.75ISO	0.75	8	0.6	0.5
1IL0.75ISO				
1IR1.0ISO	1.0	8	0.6	0.6
1IL1.0ISO				
1IR1.25ISO	1.25	8	0.6	0.7
1IL1.25ISO				
1IR1.5ISO	1.5	8	0.6	0.7
1IL1.5ISO				
1IR1.75ISO	1.75	8	0.6	0.8
1IL1.75ISO				
2ER0.35ISO	0.35	11	0.8	0.4
2EL0.35ISO				
2IR0.35ISO			0.8	0.3
2IL0.35ISO				

ER = Außen Rechts | External Right
EL und IL auf Anfrage | EL and IL upon Request

IR = Innen Rechts | Internal Right

EL = Außen Links | External Left

IL = Innen Links | Internal Left

Für kleine Bohrungen siehe Seite 112-113 | For small bore threading see page 112-113

Hartmetallqualitäten und Schnittgeschwindigkeiten siehe Seite 76-77 | For Carbide Grades and Cutting Speed see page 76-77

ISO-METRISCH / ISO-METRIC

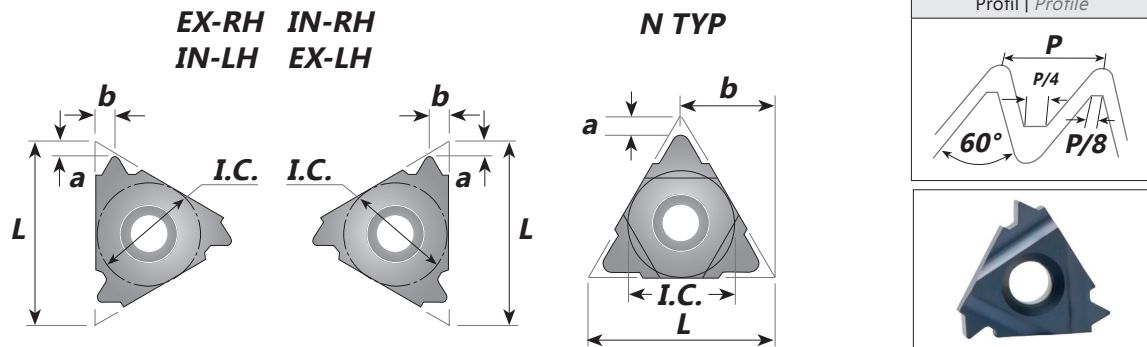

Artikelnummer (Item Number)	Steigung (Pitch) mm	Länge (Length) L	Maße in mm (Dimensions in mm)	
			a	b
2ER0.4ISO	0.4	11	0.7	0.4
2EL0.4ISO			0.8	0.4
2IR0.4ISO				
2IL0.4ISO				
2ER0.45ISO	0.45	11	0.7	0.4
2EL0.45ISO			0.8	0.4
2IR0.45ISO				
2IL0.45ISO				
2ER0.5ISO	0.5	11	0.6	0.6
2EL0.5ISO				
2IR0.5ISO				
2IL0.5ISO				
2ER0.6ISO	0.6	11	0.6	0.6
2EL0.6ISO				
2IR0.6ISO				
2IL0.6ISO				
2ER0.7ISO	0.7	11	0.6	0.6
2EL0.7ISO				
2IR0.7ISO				
2IL0.7ISO				
2ER0.75ISO	0.75	11	0.6	0.6
2EL0.75ISO				
2IR0.75ISO				
2IL0.75ISO				

ER = Außen Rechts | External Right IR = Innen Rechts | Internal Right EL = Außen Links | External Left IL = Innen Links | Internal Left
EL und IL auf Anfrage | EL and IL upon Request

Für kleine Bohrungen siehe Seite 112-113 | For small bore threading see page 112-113
Hartmetallqualitäten und Schnittgeschwindigkeiten siehe Seite 76-77 | For Carbide Grades and Cutting Speed see page 76-77

ISO-METRISCH / ISO-METRIC

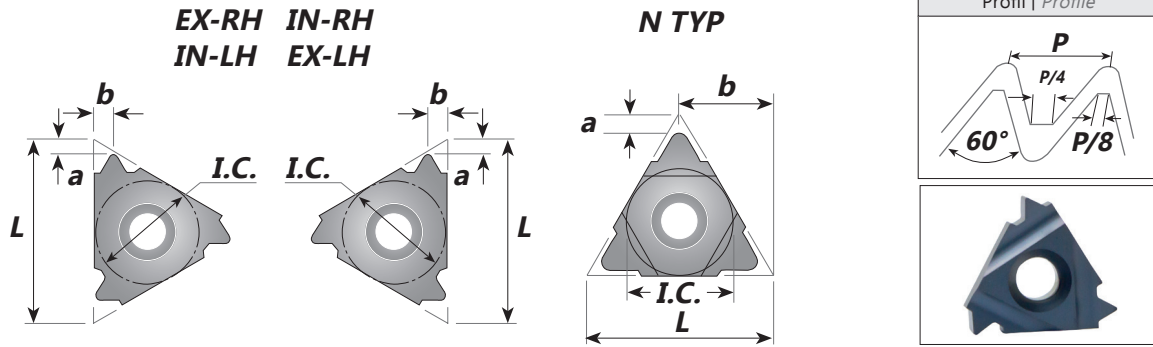

Artikelnummer (Item Number)	Steigung (Pitch) mm	Länge (Length) L	Maße in mm (Dimensions in mm)	
			a	b
2ER0.8ISO	0.8	11	0.6	0.6
2EL0.8ISO				
2IR0.8ISO				
2IL0.8ISO				
2ER1.0ISO	1.0	11	0.7	0.7
2EL1.0ISO				
2IR1.0ISO				
2IL1.0ISO				
2ER1.25ISO	1.25	11	0.8	0.9
2EL1.25ISO				
2IR1.25ISO				
2IL1.25ISO				
2ER1.5ISO	1.5	11	0.8	1.0
2EL1.5ISO				
2IR1.5ISO				
2IL1.5ISO				
2ER1.75ISO	1.75	11	0.8	1.1
2EL1.75ISO				
2IR1.75ISO				
2IL1.75ISO				
2ER2.0ISO	2.0	11	0.8	1.1
2EL2.0ISO				
2IR2.0ISO				
2IL2.0ISO				
2IR2.5ISO	2.5	11	0.8	0.9
2IL2.5ISO				

ER = Außen Rechts | External Right IR = Innen Rechts | Internal Right EL = Außen Links | External Left IL = Innen Links | Internal Left
 EL und IL auf Anfrage | EL and IL upon Request

Für kleine Bohrungen siehe Seite 112-113 | For small bore threading see page 112-113
 Hartmetallqualitäten und Schnittgeschwindigkeiten siehe Seite 76-77 | For Carbide Grades and Cutting Speed see page 76-77

ISO-METRISCH / ISO-METRIC

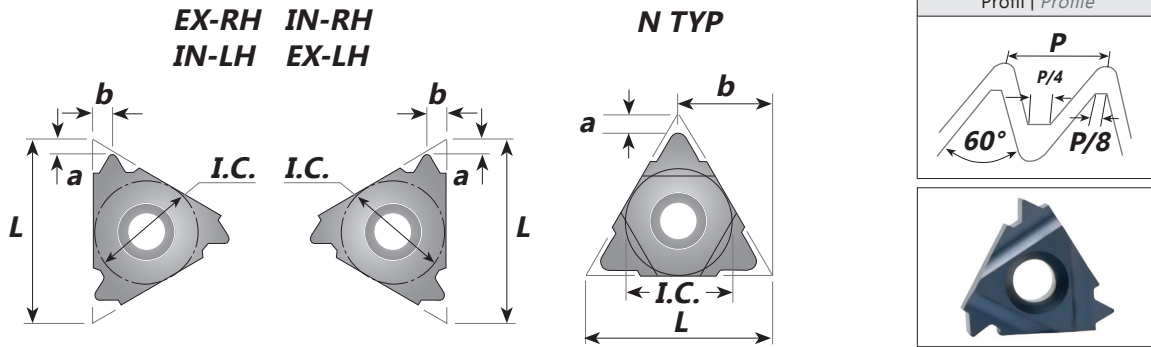

Artikelnummer (Item Number)	Steigung (Pitch)	Länge (Length) L	Maße in mm (Dimensions in mm)	
	mm		a	b
3ER0.35ISO	0.35	16	0.8	0.4
3EL0.35ISO			0.8	0.3
3IR0.35ISO				
3IL0.35ISO				
3ER0.4ISO	0.4	16	0.7	0.4
3EL0.4ISO			0.8	0.4
3IR0.4ISO				
3IL0.4ISO				
3ER0.45ISO	0.45	16	0.7	0.4
3EL0.45ISO			0.8	0.4
3IR0.45ISO				
3IL0.45ISO				
3ER0.5ISO	0.5	16	0.6	0.6
3EL0.5ISO				
3IR0.5ISO				
3IL0.5ISO				
3ER0.6ISO	0.6	16	0.6	0.6
3EL0.6ISO				
3IR0.6ISO				
3IL0.6ISO				
3ER0.7ISO	0.7	16	0.6	0.6
3EL0.7ISO				
3IR0.7ISO				
3IL0.7ISO				
3ER0.75ISO	0.75	16	0.6	0.6
3EL0.75ISO				
3IR0.75ISO				
3IL0.75ISO				
3ER0.8ISO	0.8	16	0.6	0.6
3EL0.8ISO				
3IR0.8ISO				
3IL0.8ISO				

ER = Außen Rechts | External Right
EL und IL auf Anfrage | EL and IL upon Request

IR = Innen Rechts | Internal Right

EL = Außen Links | External Left

IL = Innen Links | Internal Left

ISO-METRISCH / ISO-METRIC

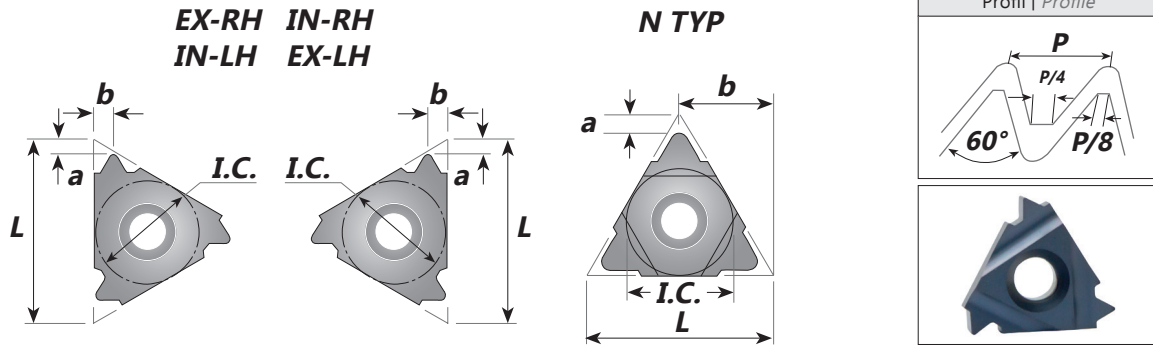

Artikelnummer (Item Number)	Steigung (Pitch) mm	Länge (Length) L	Maße in mm (Dimensions in mm)	
			a	b
3ER1.0ISO	1.0	16	0.7	0.7
3EL1.0ISO			0.6	0.7
3IR1.0ISO				
3IL1.0ISO				
3ER1.25ISO	1.25	16	0.8	0.9
3EL1.25ISO			0.8	1.0
3IR1.25ISO				
3IL1.25ISO				
3ER1.5ISO	1.5	16	0.8	1.0
3EL1.5ISO			0.9	1.2
3IR1.5ISO				
3IL1.5ISO				
3ER1.75ISO	1.75	16	0.9	1.2
3EL1.75ISO			1.0	1.3
3IR1.75ISO				
3IL1.75ISO				
3ER2.0ISO	2.0	16	1.0	1.3
3EL2.0ISO			1.1	1.5
3IR2.0ISO				
3IL2.0ISO				
3ER2.5ISO	2.5	16	1.1	1.5
3EL2.5ISO			1.2	1.6
3IR2.5ISO				
3IL2.5ISO				
3ER3.0ISO	3.0	16	1.2	1.6
3EL3.0ISO			1.1	1.5
3IR3.0ISO				
3IL3.0ISO				
3ER3.5ISO	3.5	16	1.2	1.7
3EL3.5ISO			1.2	1.7
3IR3.5ISO				
3IL3.5ISO				

ER = Außen Rechts | External Right
EL und IL auf Anfrage | EL and IL upon Request

IR = Innen Rechts | Internal Right

EL = Außen Links | External Left

IL = Innen Links | Internal Left

ISO-METRISCH / ISO-METRIC

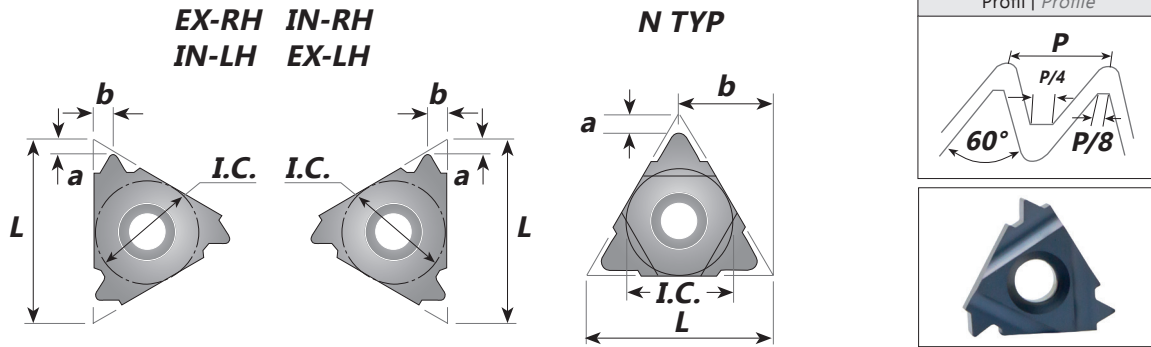

Artikelnummer (Item Number)	Steigung (Pitch) mm	Länge (Length) L	Maße in mm (Dimensions in mm)	
			a	b
4ER3.5ISO	3.5	22	1.6	2.3
4EL3.5ISO				
4IR3.5ISO				
4IL3.5ISO				
4ER4.0ISO	4.0	22	1.6	2.3
4EL4.0ISO				
4IR4.0ISO				
4IL4.0ISO				
4ER4.5ISO	4.5	22	1.7	2.4
4EL4.5ISO			1.6	2.4
4IR4.5ISO				
4IL4.5ISO				
4ER5.0ISO	5.0	22	1.7	2.5
4EL5.0ISO			1.6	2.3
4IR5.0ISO				
4IL5.0ISO				
4EL5.5ISO	5.5	22	1.7	2.6
4IR5.5ISO			1.6	2.3
4IL5.5ISO				
4ER6.0ISO*				
4EL6.0ISO	1.6	2.4		
4IR6.0ISO				
4IL6.0ISO				

ER = Außen Rechts | *External Right* IR = Innen Rechts | *Internal Right* EL = Außen Links | *External Left* IL = Innen Links | *Internal Left*
 EL und IL auf Anfrage | *EL and IL upon Request*

*Spezieller Halter erforderlich | *Special holder is required*

Hartmetallqualitäten und Schnittgeschwindigkeiten siehe Seite 76-77 | *For Carbide Grades and Cutting Speed see page 76-77*

ISO-METRISCH | ISO-METRIC

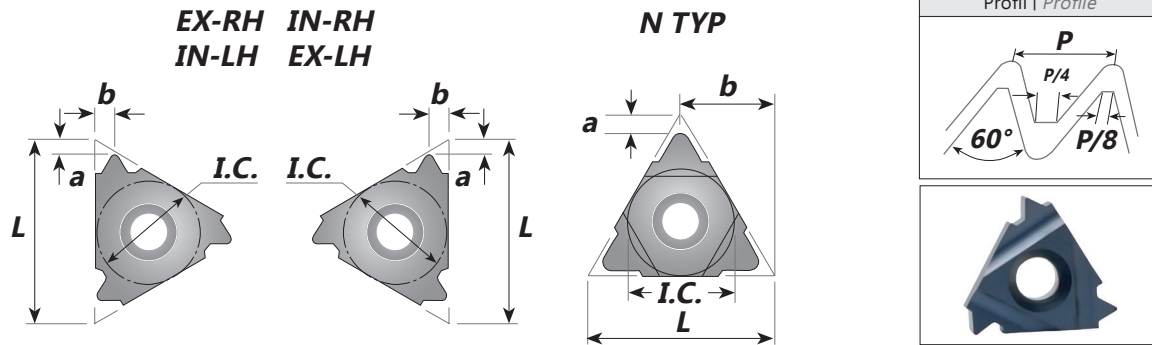

Artikelnummer (Item Number)	Steigung (Pitch) mm	Länge (Length) L	Maße in mm (Dimensions in mm)	
			a	b
4NER/L5.5ISO	5.5	22N	2.3	11.0
4NIR/L5.5ISO			2.4	11.0
4NER/L6.0ISO	6.0	22N	2.6	11.0
4NIR/L6.0ISO			2.1	11.0
5ER5.5ISO	5.5	27	1.9	2.7
5EL5.5ISO			1.6	2.3
5IR5.5ISO				
5IL5.5ISO				
5ER6.0ISO	6.0	27	2.0	2.9
5EL6.0ISO			1.8	2.5
5IR6.0ISO				
5IL6.0ISO				

ER = Außen Rechts | *External Right* IR = Innen Rechts | *Internal Right* EL = Außen Links | *External Left* IL = Innen Links | *Internal Left*
 EL und IL auf Anfrage | *EL and IL upon Request*

ISO-METRISCH | ISO-METRIC VERTIKAL | VERTICAL

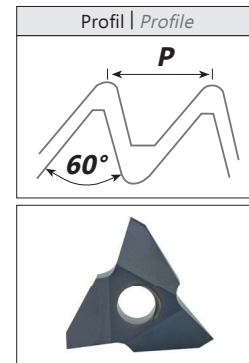
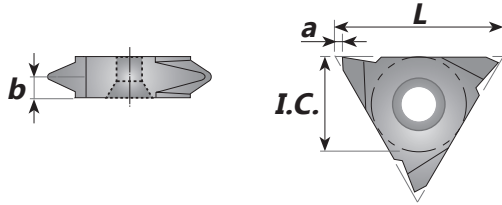

Artikelnummer (Item Number)	Steigung (Pitch) mm	Länge (Length) L	Maße in mm (Dimensions in mm)	
			a	b
3VER0.5ISO	0.5	16	1.0	0.6
3VEL0.5ISO				
3VER0.75ISO	0.75	16	1.0	0.6
3VEL0.75ISO				
3VER0.8ISO	0.8	16	1.0	0.6
3VEL0.8ISO				
3VER1.0ISO	1.0	16	1.0	0.7
3VEL1.0ISO				
3VER1.25ISO	1.25	16	1.0	0.9
3VEL1.25ISO				
3VER1.5ISO	1.5	16	1.0	0.9
3VEL1.5ISO				
3VER1.75ISO	1.75	16	1.0	1.2
3VEL1.75ISO				
3VER2.0ISO	2.0	16	1.0	1.3
3VEL2.0ISO				
3VER2.5ISO	2.5	16	1.0	1.5
3VEL2.5ISO				
3VER3.0ISO	3.0	16	1.0	1.7
3VEL3.0ISO				

ER = Außen Rechts | External Right IR = Innen Rechts | Internal Right EL = Außen Links | External Left IL = Innen Links | Internal Left
 EL und IL auf Anfrage | EL and IL upon Request

Hartmetallqualitäten und Schnittgeschwindigkeiten siehe Seite 76-77 | For Carbide Grades and Cutting Speed see page 76-77

ISO-METRISCH | ISO-METRIC

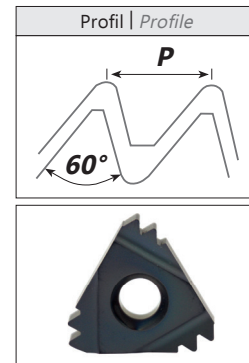
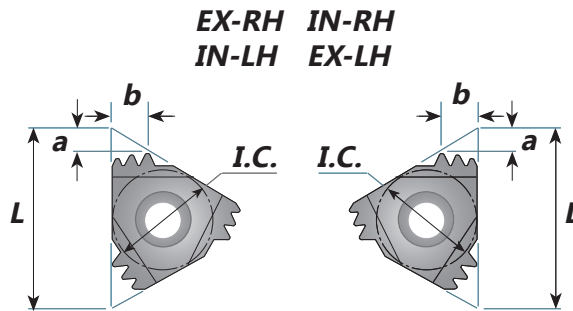

Mehrzahn | Multi-tooth

Artikelnummer (Item Number)	Steigung (Pitch) mm	Länge (Length) L	Maße in mm (Dimensions in mm)	
			a	b
3ER1.0ISO3M	1.0	16	1.7	2.5
3IR1.0ISO3M				
3ER1.5ISO2M	1.5	16	1.5	2.3
3IR1.5ISO2M				
4ER1.5ISO3M	1.5	22	2.3	3.7
4IR1.5ISO3M				
4ER2.0ISO2M	2.0	22	2.0	3.0
4IR2.0ISO2M				
4ER2.0ISO3M	2.0	22	3.1	5.0
4IR2.0ISO3M				
5ER3.0ISO2M	3.0	27	2.9	4.6
5IR3.0ISO2M				

ER = Außen Rechts | *External Right* IR = Innen Rechts | *Internal Right*

UN UNIFIED UNC, UNF, UNEF, UNS

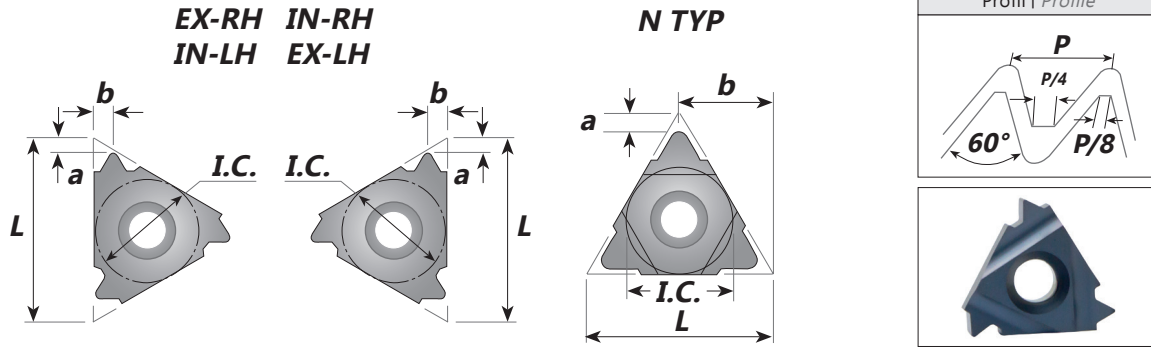

Artikelnummer (Item Number)	Steigung (Pitch)	Länge (Length)	Maße in mm (Dimensions in mm)	
	Gänge/Zoll (TPI)		a	b
0IR32UN	32	6	0.8	0.5
0IL32UN				
0IR28UN	28	6	0.8	0.6
0IL28UN				
0IR24UN	24	6	0.7	0.6
0IL24UN				
0IR20UN	20	6	0.6	0.6
0IL20UN				
0IR18UN	18	6	0.6	0.7
0IL18UN				

ER = Außen Rechts | External Right IR = Innen Rechts | Internal Right EL = Außen Links | External Left IL = Innen Links | Internal Left
 EL und IL auf Anfrage | EL and IL upon Request

UN UNIFIED UNC, UNF, UNEF, UNS

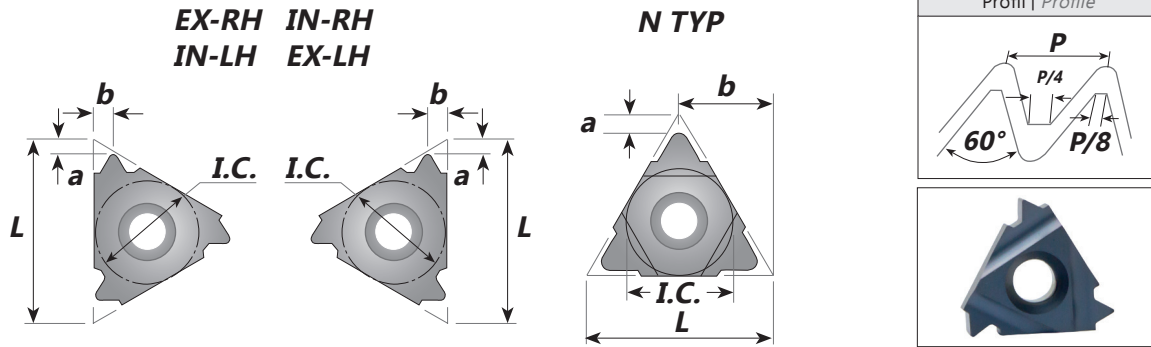

Artikelnummer (Item Number)	Steigung (Pitch) Gänge/Zoll (TPI)	Länge (Length) L	Maße in mm (Dimensions in mm)	
			a	b
1IR32UN	32	8	0.6	0.5
1IL32UN				
1IR28UN	28	8	0.6	0.6
1IL28UN				
1IR24UN	24	8	0.6	0.6
1IL24UN				
1IR20UN	20	8	0.6	0.7
1IL20UN				
1IR18UN	18	8	0.6	0.7
1IL18UN				
1IR16UN	16	8	0.6	0.7
1IL16UN				
1IR14UN	14	8	0.6	0.8
1IL14UN				
1IR13UN	13	8	0.8	0.9
2ER72UN				
2EL72UN	72	11	0.8	0.4
2IR72UN				
2IL72UN	64	11	0.8	0.3
2ER64UN				
2EL64UN	64	11	0.8	0.4
2IR64UN				
2IL64UN	56	11	0.7	0.4
2ER56UN				
2EL56UN	56	11	0.7	0.4
2IR56UN				
2IL56UN				

ER = Außen Rechts | External Right IR = Innen Rechts | Internal Right EL = Außen Links | External Left IL = Innen Links | Internal Left
 EL und IL auf Anfrage | EL and IL upon Request

Hartmetallqualitäten und Schnittgeschwindigkeiten siehe Seite 76-77 | For Carbide Grades and Cutting Speed see page 76-77

UN UNIFIED UNC, UNF, UNEF, UNS

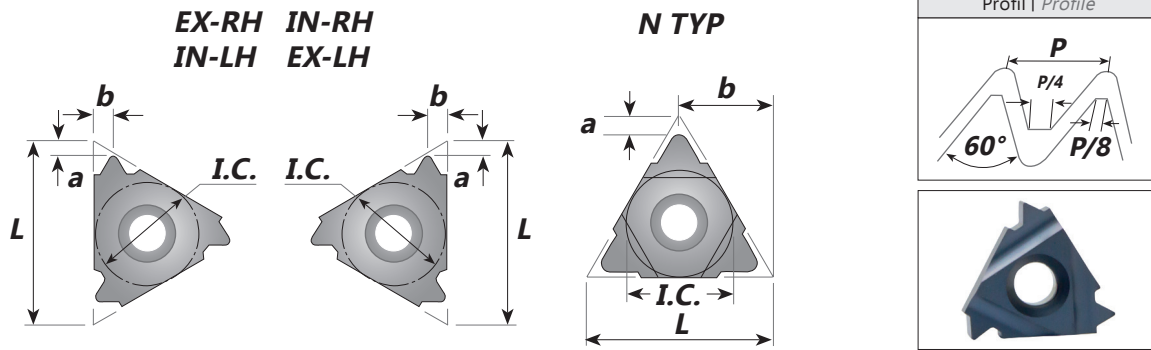

Artikelnummer (Item Number)	Steigung (Pitch)	Länge (Length) L	Maße in mm (Dimensions in mm)	
	Gänge/Zoll (TPI)		a	b
2ER48UN	48	11	0.6	0.6
2EL48UN				
2IR48UN				
2IL48UN				
2ER44UN	44	11	0.6	0.6
2EL44UN				
2IR44UN				
2IL44UN				
2ER40UN	40	11	0.6	0.6
2EL40UN				
2IR40UN				
2IL40UN				
2ER36UN	36	11	0.6	0.6
2EL36UN				
2IR36UN				
2IL36UN				
2ER32UN	32	11	0.6	0.6
2EL32UN				
2IR32UN				
2IL32UN				
2ER28UN	28	11	0.6	0.7
2EL28UN				
2IR28UN				
2IL28UN				
2ER27UN	27	11	0.7	0.8
2EL27UN				
2IR27UN				
2IL27UN				

ER = Außen Rechts | External Right IR = Innen Rechts | Internal Right EL = Außen Links | External Left IL = Innen Links | Internal Left
 EL und IL auf Anfrage | EL and IL upon Request

Hartmetallqualitäten und Schnittgeschwindigkeiten siehe Seite 76-77 | For Carbide Grades and Cutting Speed see page 76-77

UN UNIFIED UNC, UNF, UNEF, UNS

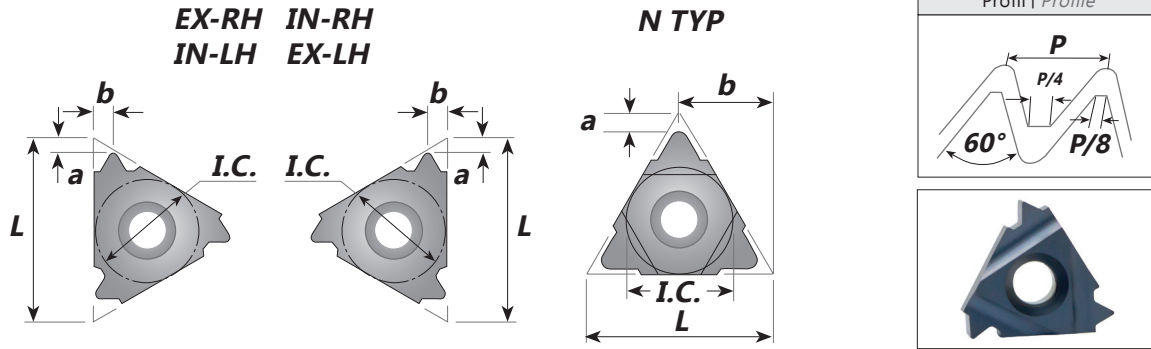

Artikelnummer (Item Number)	Steigung (Pitch)	Länge (Length) L	Maße in mm (Dimensions in mm)	
	Gänge/Zoll (TPI)		a	b
2ER24UN	24	11	0.7	0.8
2EL24UN				
2IR24UN				
2IL24UN				
2ER20UN	20	11	0.8	0.9
2EL20UN				
2IR20UN				
2IL20UN				
2ER18UN	18	11	0.8	1.0
2EL18UN				
2IR18UN				
2IL18UN				
2ER16UN	16	11	0.9	1.1
2EL16UN				
2IR16UN				
2IL16UN				
2ER14UN	14	11	0.9	1.1
2EL14UN				
2IR14UN				
2IL14UN				
3ER72UN	72	16	0.8	0.4
3EL72UN			0.8	0.3
3IR72UN				
3IL72UN				
3ER64UN	64	16	0.8	0.4
3EL64UN				
3IR64UN				
3IL64UN				

ER = Außen Rechts | External Right IR = Innen Rechts | Internal Right EL = Außen Links | External Left IL = Innen Links | Internal Left
 EL und IL auf Anfrage | EL and IL upon Request

Hartmetallqualitäten und Schnittgeschwindigkeiten siehe Seite 76-77 | For Carbide Grades and Cutting Speed see page 76-77

UN UNIFIED UNC, UNF, UNEF, UNS

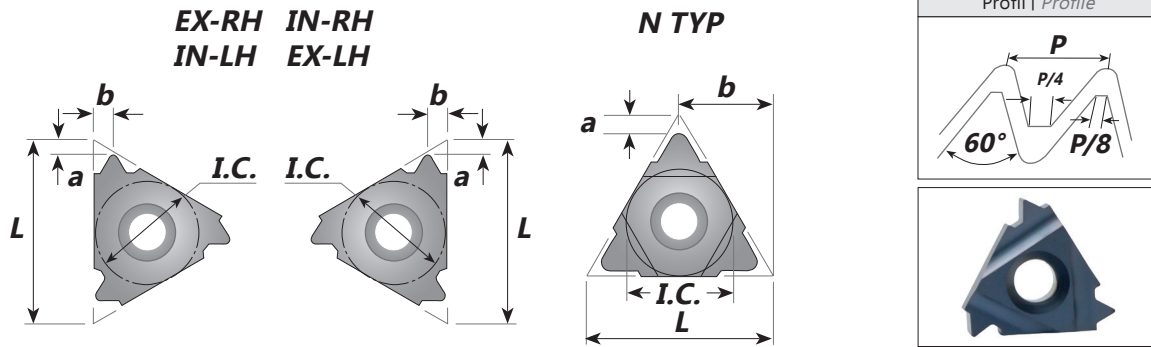

Artikelnummer (Item Number)	Steigung (Pitch)	Länge (Length) L	Maße in mm (Dimensions in mm)	
	Gänge/Zoll (TPI)		a	b
2IR13UN	13	11	0.8	1.0
2IL13UN				
2IR12UN	12	11	0.9	1.1
2IL12UN				
2IR11UN	11	11	0.8	1.1
2IL11UN				
3ER72UN	72	16	0.8	0.4
3EL72UN				
3IR72UN			0.8	0.3
3IL72UN				
3ER64UN	64	16	0.8	0.4
3EL64UN				
3IR64UN				
3IL64UN				
3ER56UN	56	16	0.7	0.4
3EL56UN				
3IR56UN				
3IL56UN				
3ER48UN	48	16	0.6	0.6
3EL48UN				
3IR48UN				
3IL48UN				
3ER44UN	44	16	0.6	0.6
3EL44UN				
3IR44UN				
3IL44UN				
3ER40UN	40	16	0.6	0.6
3EL40UN				
3IR40UN				
3IL40UN				

ER = Außen Rechts | External Right IR = Innen Rechts | Internal Right EL = Außen Links | External Left IL = Innen Links | Internal Left
 EL und IL auf Anfrage | EL and IL upon Request

Hartmetallqualitäten und Schnittgeschwindigkeiten siehe Seite 76-77 | For Carbide Grades and Cutting Speed see page 76-77

UN UNIFIED UNC, UNF, UNEF, UNS

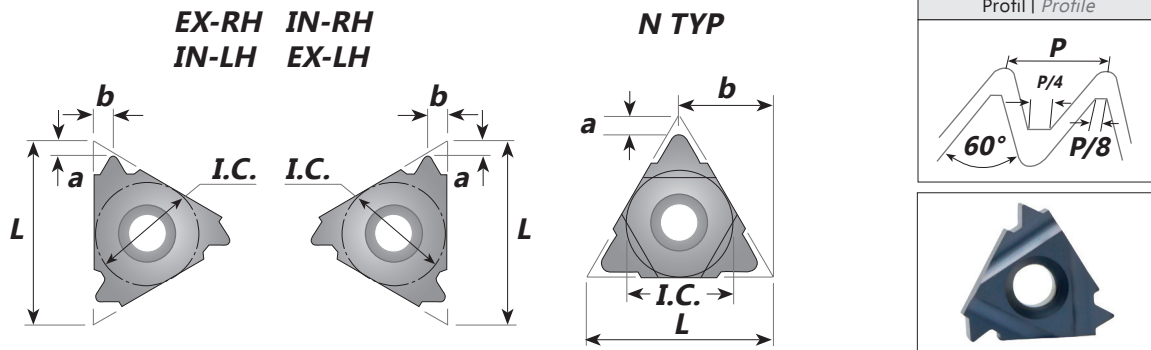

Artikelnummer (Item Number)	Steigung (Pitch)	Länge (Length) L	Maße in mm (Dimensions in mm)	
	Gänge/Zoll (TPI)		a	b
3ER36UN	36	16	0.6	0.6
3EL36UN				
3IR36UN				
3IL36UN				
3ER32UN	32	16	0.6	0.6
3EL32UN				
3IR32UN				
3IL32UN				
3ER28UN	28	16	0.6	0.7
3EL28UN				
3IR28UN				
3IL28UN				
3ER27UN	27	16	0.7	0.8
3EL27UN				
3IR27UN				
3IL27UN				
3ER24UN	24	16	0.7	0.8
3EL24UN				
3IR24UN				
3IL24UN				
3ER20UN	20	16	0.8	0.9
3EL20UN				
3IR20UN				
3IL20UN				
3ER18UN	18	16	0.8	1.0
3EL18UN				
3IR18UN				
3IL18UN				
3ER16UN	16	16	0.9	1.1
3EL16UN				
3IR16UN				
3IL16UN				

ER = Außen Rechts | External Right IR = Innen Rechts | Internal Right EL = Außen Links | External Left IL = Innen Links | Internal Left
 EL und IL auf Anfrage | EL and IL upon Request

UN UNIFIED UNC, UNF, UNEF, UNS

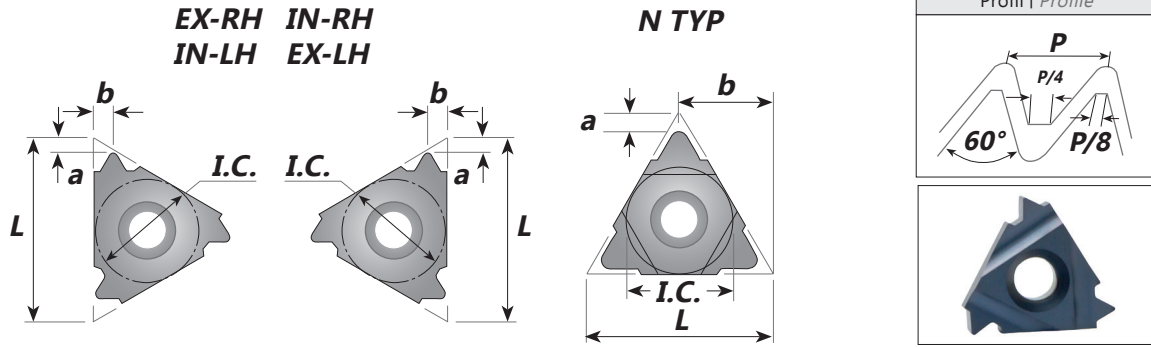

Artikelnummer (Item Number)	Steigung (Pitch)	Länge (Length) L	Maße in mm (Dimensions in mm)	
	Gänge/Zoll (TPI)		a	b
3ER14UN	14	16	1.0	1.2
3EL14UN			0.9	1.2
3IR14UN				
3IL14UN				
3ER13UN	13	16	1.0	1.3
3EL13UN				
3IR13UN				
3IL13UN				
3ER12UN	12	16	1.1	1.4
3EL12UN				
3IR12UN				
3IL12UN				
3ER11.5UN	11.5	16	1.1	1.5
3EL11.5UN				
3IR11.5UN				
3IL11.5UN				
3ER11UN	11	16	1.1	1.5
3EL11UN				
3IR11UN				
3IL11UN				
3ER10UN	10	16	1.1	1.5
3EL10UN				
3IR10UN				
3IL10UN				
3ER9UN	9	16	1.2	1.7
3EL9UN				
3IR9UN				
3IL9UN				
3ER8UN	8	16	1.2	1.6
3EL8UN			1.1	1.5
3IR8UN				
3IL8UN				

ER = Außen Rechts | External Right IR = Innen Rechts | Internal Right EL = Außen Links | External Left IL = Innen Links | Internal Left
 EL und IL auf Anfrage | EL and IL upon Request

UN UNIFIED UNC, UNF, UNEF, UNS

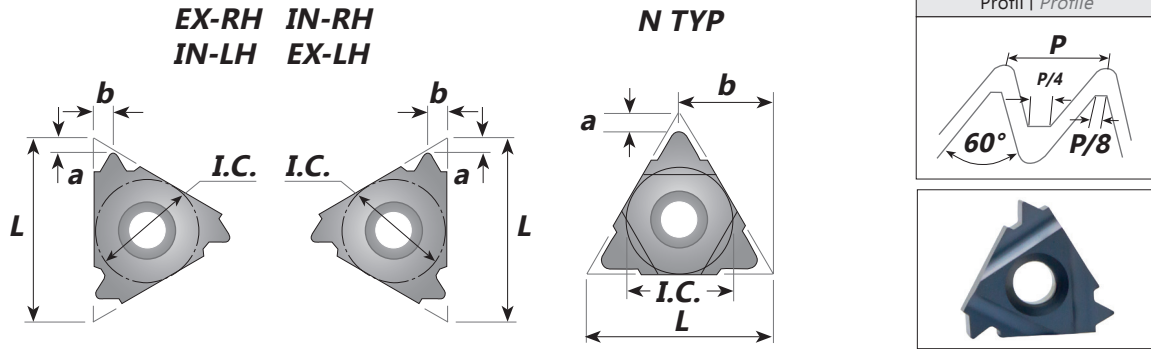

Artikelnummer (Item Number)	Steigung (Pitch)	Länge (Length) L	Maße in mm (Dimensions in mm)	
	Gänge/Zoll (TPI)		a	b
4ER7UN	7	22	1.6	2.3
4EL7UN				
4IR7UN				
4IL7UN				
4ER6UN	6	22	1.6	2.3
4EL6UN				
4IR6UN				
4IL6UN				
4ER5UN	5	22	1.7	2.5
4EL5UN			1.6	2.3
4IR5UN				
4IL5UN				
5ER4.5UN	4.5	27	1.9	2.7
5EL4.5UN			1.7	2.4
5IR4.5UN				
5IL4.5UN				
5ER4UN	4	27	2.5	13.7
5EL4UN			2.8	16.5
5IR4UN				
5IL4UN				

ER = Außen Rechts | External Right IR = Innen Rechts | Internal Right EL = Außen Links | External Left IL = Innen Links | Internal Left
 EL und IL auf Anfrage | EL and IL upon Request

UN UNIFIED UNC, UNF, UNEF, UNS

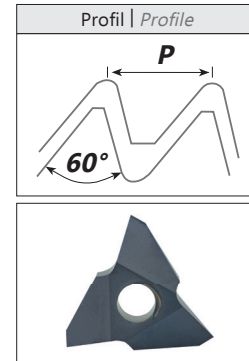
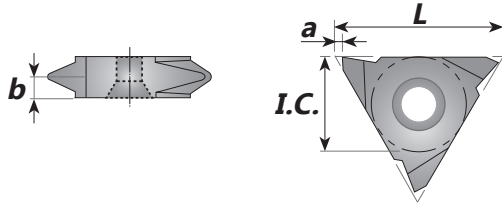

Vertikal | Vertical

Artikelnummer (Item Number)	Steigung (Pitch)	Länge (Length)	Maße in mm (Dimensions in mm)	
	Gänge/Zoll (TPI)	L	a	b
3VER32UN	32	16	1.0	0.6
3VEL32UN				
3VER28UN	28	16	1.0	0.7
3VEL28UN				
3VER24UN	24	16	1.0	0.8
3VEL24UN				
3VER20UN	20	16	1.0	0.9
3VEL20UN				
3VER18UN	18	16	1.0	1.0
3VEL18UN				
3VER16UN	16	16	1.0	1.1
3VEL16UN				
3VER14UN	14	16	1.0	1.2
3VEL14UN				
3VER12UN	12	16	1.0	1.4
3VEL12UN				
3VER10UN	10	16	1.0	1.5
3VEL10UN				
3VER8UN	8	16	1.0	1.6
3VEL8UN				

ER = Außen Rechts | External Right

IR = Innen Rechts | Internal Right

EL = Außen Links | External Left

IL = Innen Links | Internal Left

EL und IL auf Anfrage | EL and IL upon Request

WHITWORTH 55° BSW, BSF, BSP, BSB

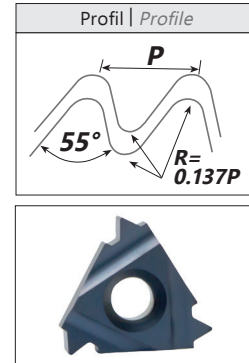
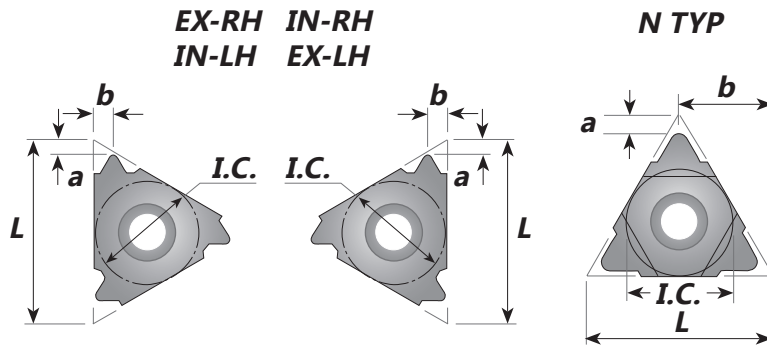

Artikelnummer (Item Number)	Steigung (Pitch)	Länge (Length) L	Maße in mm (Dimensions in mm)	
	Gänge/Zoll (TPI)		a	b
0IR26W	26	6	0.7	0.6
0IL26W				
0IR22W	22	6	0.6	0.6
0IL22W				
0IR20W	20	6	0.6	0.7
0IL20W				
0IR18W	18	6	0.6	0.7
0IL18W				
1IR28W	28	8	0.6	0.6
1IL28W				
1IR24W	24	8	0.6	0.6
1IL24W				
1IR20W	20	8	0.6	0.7
1IL20W				
1IR19W	19	8	0.6	0.7
1IL19W				
1IR18W	18	8	0.6	0.7
1IL18W				
1IR16W	16	8	0.6	0.7
1IL16W				

IR = Innen Rechts | Internal Right

IL = Innen Links | Internal Left

WHITWORTH 55° BSW, BSF, BSP, BSB

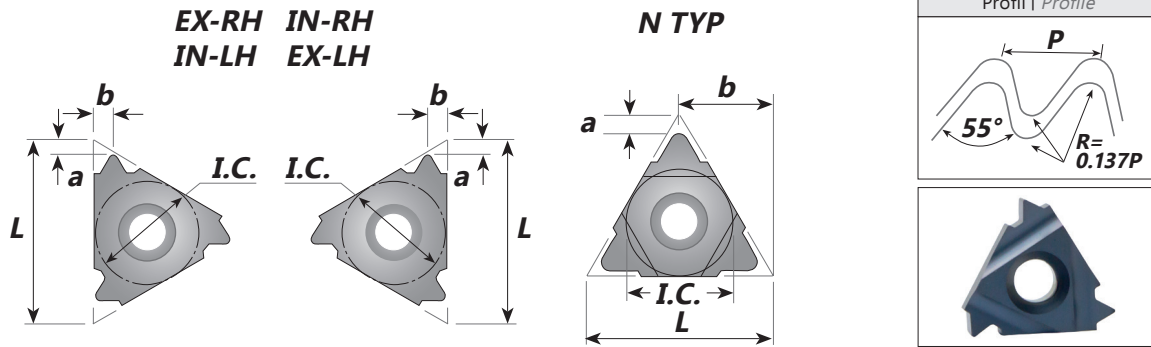

Artikelnummer (Item Number)	Steigung (Pitch)	Länge (Length) L	Maße in mm (Dimensions in mm)	
	Gänge/Zoll (TPI)		a	b
2ER72W	72	11	0.7	0.4
2EL72W				
2IR72W				
2IL72W				
2ER60W	60	11	0.7	0.4
2EL60W				
2IR60W				
2IL60W				
2ER56W	56	11	0.7	0.4
2EL56W				
2IR56W				
2IL56W				
2ER48W	48	11	0.6	0.6
2EL48W				
2IR48W				
2IL48W				
2ER40W	40	11	0.6	0.6
2IR40W				
2EL40W				
2IL40W				
2ER36W	36	11	0.6	0.6
2IR36W				
2EL36W				
2IL36W				
2ER32W	32	11	0.6	0.6
2IR32W				
2EL32W				
2IL32W				
2ER28W	28	11	0.6	0.7
2IR28W				
2EL28W				
2IL28W				

ER = Außen Rechts | External Right IR = Innen Rechts | Internal Right EL = Außen Links | External Left IL = Innen Links | Internal Left
 EL und IL auf Anfrage | EL and IL upon Request

WHITWORTH 55° BSW, BSF, BSP, BSB

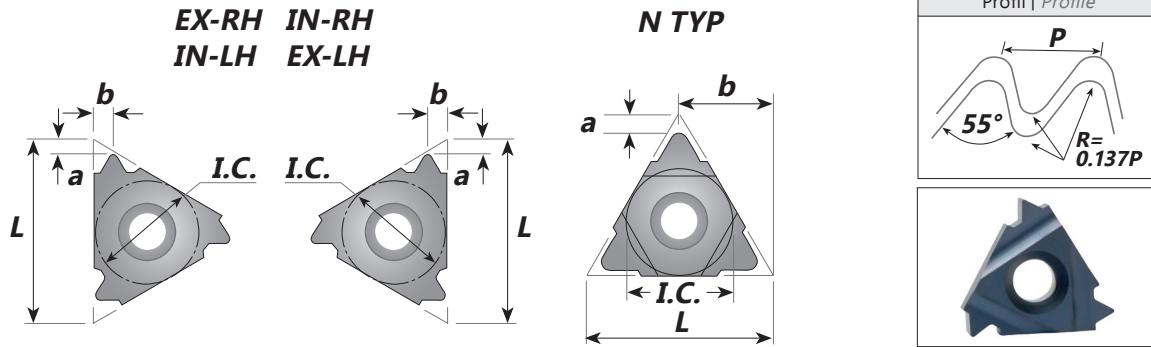

Artikelnummer (Item Number)	Steigung (Pitch)	Länge (Length) L	Maße in mm (Dimensions in mm)	
	Gänge/Zoll (TPI)		a	b
2ER26W	26	11	0.7	0.7
2IR26W				
2EL26W				
2IL26W				
2ER24W	24	11	0.7	0.8
2IR24W				
2EL24W				
2IL24W				
2ER22W	22	11	0.8	0.9
2IR22W				
2EL22W				
2IL22W				
2ER20W	20	11	0.8	0.9
2IR20W				
2EL20W				
2IL20W				
2ER19W	19	11	0.8	1.0
2IR19W				
2EL19W				
2IL19W				
2ER18W	18	11	0.8	1.0
2IR18W				
2EL18W				
2IL18W				
2ER16W	16	11	0.9	1.1
2IR16W				
2EL16W				
2IL16W				

ER = Außen Rechts | External Right IR = Innen Rechts | Internal Right EL = Außen Links | External Left IL = Innen Links | Internal Left
 EL und IL auf Anfrage | EL and IL upon Request

Hartmetallqualitäten und Schnittgeschwindigkeiten siehe Seite 76-77 | For Carbide Grades and Cutting Speed see page 76-77

WHITWORTH 55° BSW, BSF, BSP, BSB

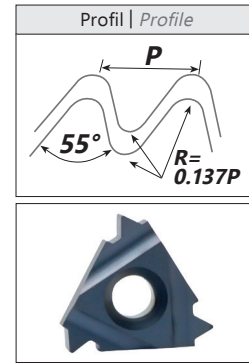
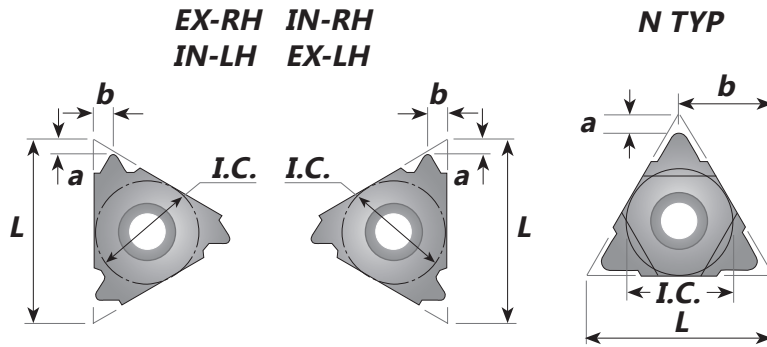

Artikelnummer (Item Number)	Steigung (Pitch)	Länge (Length) L	Maße in mm (Dimensions in mm)	
	Gänge/Zoll (TPI)		a	b
2ER14W	14	11	0.9	1.1
2IR14W				
2EL14W				
2IL14W				
2IR12W	12	11	1.0	1.1
2IL12W				
2IR11W*	11	11	0.9	1.2
2IL11W*				
3ER72W	72	16	0.7	0.4
3IR72W				
3EL72W				
3IL72W				
3ER60W	60	16	0.7	0.4
3IR60W				
3EL60W				
3IL60W				
3ER56W	56	16	0.7	0.4
3IR56W				
3EL56W				
3IL56W				
3ER48W	48	16	0.6	0.6
3IR48W				
3EL48W				
3IL48W				
3ER40W	40	16	0.6	0.6
3IR40W				
3EL40W				
3IL40W				

ER = Außen Rechts | External Right IR = Innen Rechts | Internal Right EL = Außen Links | External Left IL = Innen Links | Internal Left
 EL und IL auf Anfrage | EL and IL upon Request

*Erfordert speziellen Halter oder einen selbstständig modifizierten Standardhalter |
 Special holder is required or standard holder can be modified by customer

Hartmetallqualitäten und Schnittgeschwindigkeiten siehe Seite 76-77 | For Carbide Grades and Cutting Speed see page 76-77

WHITWORTH 55° BSW, BSF, BSP, BSB

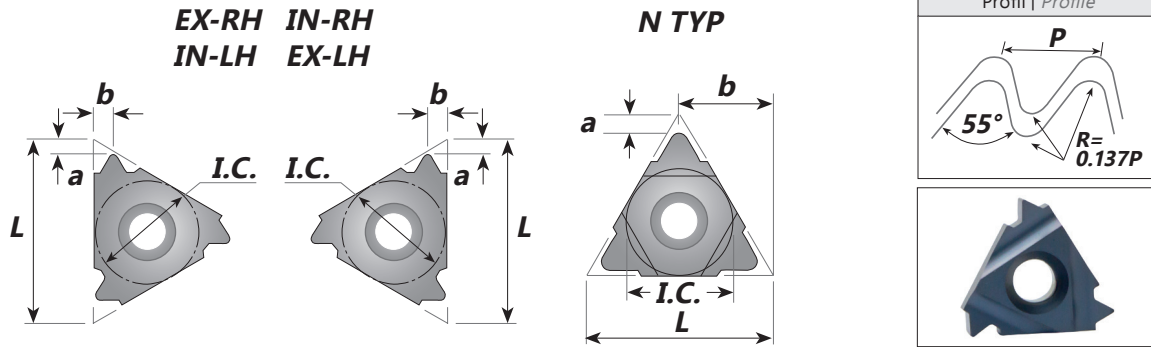

Artikelnummer (Item Number)	Steigung (Pitch)	Länge (Length) L	Maße in mm (Dimensions in mm)	
	Gänge/Zoll (TPI)		a	b
3ER36W	36	16	0.6	0.6
3IR36W				
3EL36W				
3IL36W				
3ER32W	32	16	0.6	0.6
3IR32W				
3EL32W				
3IL32W				
3ER28W	28	16	0.6	0.7
3IR28W				
3EL28W				
3IL28W				
3ER26W	26	16	0.7	0.7
3IR26W				
3EL26W				
3IL26W				
3ER24W	24	16	0.7	0.8
3IR24W				
3EL24W				
3IL24W				
3ER22W	22	16	0.8	0.9
3IR22W				
3EL22W				
3IL22W				
3ER20W	20	16	0.8	0.9
3IR20W				
3EL20W				
3IL20W				

ER = Außen Rechts | External Right IR = Innen Rechts | Internal Right EL = Außen Links | External Left IL = Innen Links | Internal Left
 EL und IL auf Anfrage | EL and IL upon Request

Hartmetallqualitäten und Schnittgeschwindigkeiten siehe Seite 76-77 | For Carbide Grades and Cutting Speed see page 76-77

WHITWORTH 55° BSW, BSF, BSP, BSB

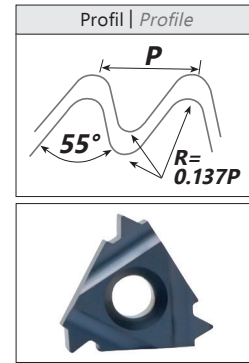
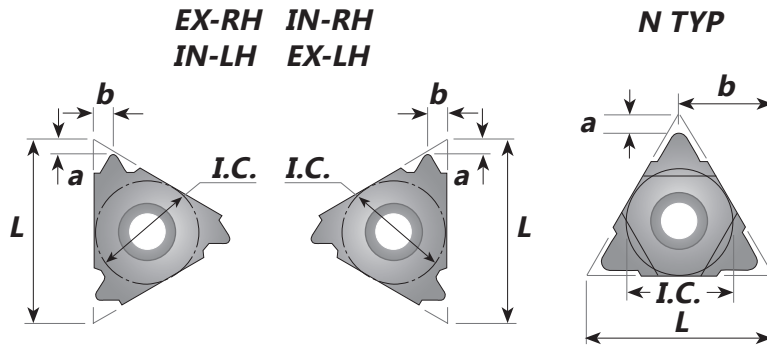

Artikelnummer (Item Number)	Steigung (Pitch)	Länge (Length) L	Maße in mm (Dimensions in mm)	
	Gänge/Zoll (TPI)		a	b
3ER19W	19	16	0.8	1.0
3IR19W				
3EL19W				
3IL19W				
3ER18W	18	16	0.8	1.0
3IR18W				
3EL18W				
3IL18W				
3ER16W	16	16	0.9	1.1
3IR16W				
3EL16W				
3IL16W				
3ER14W	14	16	1.0	1.2
3IR14W				
3EL14W				
3IL14W				
3ER12W	12	16	1.1	1.4
3IR12W				
3EL12W				
3IL12W				
3ER11W	11	16	1.1	1.5
3IR11W				
3EL11W				
3IL11W				
3ER10W	10	16	1.1	1.5
3IR10W				
3EL10W				
3IL10W				
3ER9W	9	16	1.2	1.7
3IR9W				
3EL9W				
3IL9W				

ER = Außen Rechts | External Right IR = Innen Rechts | Internal Right
EL und IL auf Anfrage | EL and IL upon Request

EL = Außen Links | External Left

IL = Innen Links | Internal Left

WHITWORTH 55° BSW, BSF, BSP, BSB

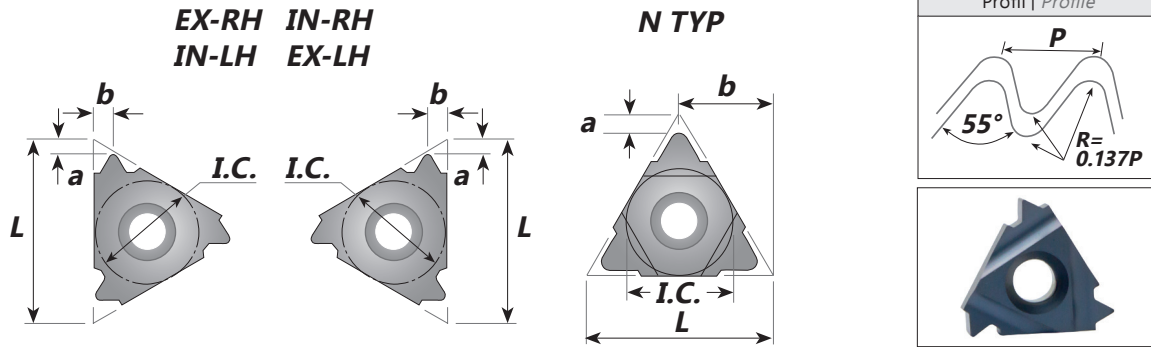

Artikelnummer (Item Number)	Steigung (Pitch) Gänge/Zoll (TPI)	Länge (Length) L	Maße in mm (Dimensions in mm)	
			a	b
3ER8W	8	16	1.2	1.5
3IR8W				
3EL8W				
3IL8W				
4ER7W	7	22	1.6	2.3
4IR7W				
4EL7W				
4IL7W				
4ER6W	6	22	1.6	2.3
4IR6W				
4EL6W				
4IL6W				
4ER5W	5	22	1.7	2.4
4IR5W				
4EL5W				
4IL5W				
5ER4.5W	4.5	27	1.8	2.6
5IR4.5W				
5EL4.5W				
5IL4.5W				
5ER4W	4	27	2.0	2.9
5IR4W				
5EL4W				
5IL4W				

ER = Außen Rechts | External Right IR = Innen Rechts | Internal Right EL = Außen Links | External Left IL = Innen Links | Internal Left
 EL und IL auf Anfrage | EL and IL upon Request

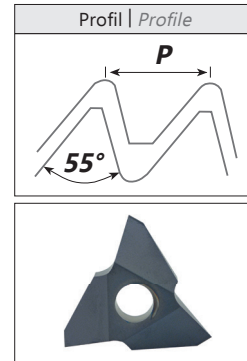
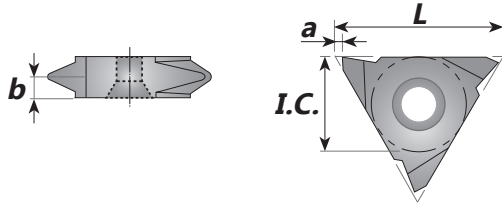
**WHITWORTH 55° BSW, BSF, BSP, BSB
VERTIKAL | VERTICAL**

Artikelnummer (Item Number)	Steigung (Pitch)	Länge (Length)	Maße in mm (Dimensions in mm)	
	Gänge/Zoll (TPI)	L	a	b
3VER20W	20	16	1.0	0.9
3VEL20W				
3VER19W	19	16	1.0	0.9
3VEL19W				
3VER18W	18	16	1.0	1.0
3VEL18W				
3VER16W	16	16	1.0	1.0
3VEL16W				
3VER14W	14	16	1.0	1.2
3VEL14W				
3VER12W	12	16	1.0	1.4
3VEL12W				
3VER11W	11	16	1.0	1.5
3VEL11W				

 ER = Außen Rechts | *External Right*

 EL = Außen Links | *External Left*

 Hartmetallqualitäten und Schnittgeschwindigkeiten siehe Seite 76-77 | *For Carbide Grades and Cutting Speed see page 76-77*

NPT

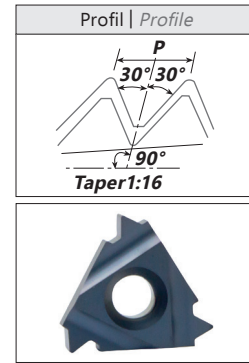
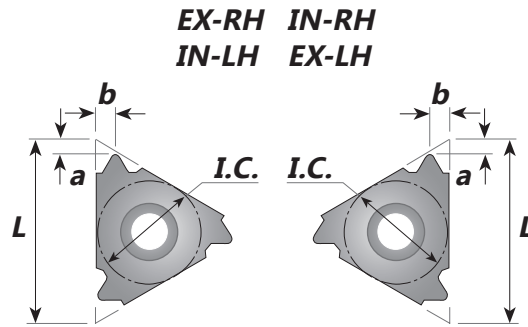

Artikelnummer (Item Number)	Steigung (Pitch)	Länge (Length)	Maße in mm (Dimensions in mm)	
	Gänge/Zoll (TPI)		a	b
0IR27NPT	27	6	0.6	0.6
0IL27NPT				
1IR27NPT	27	8	0.6	0.6
1IL27NPT				
1IR18NPT	18	8	0.6	0.6
1IL18NPT				
2ER27NPT	27	11	0.7	0.8
2EL27NPT				
2IR27NPT				
2IL27NPT				
2ER18NPT	18	11	0.8	1.0
2EL18NPT				
2IR18NPT				
2IL18NPT				
2ER14NPT	14	11	0.8	1.0
2EL14NPT				
2IR14NPT				
2IL14NPT				
3ER27NPT	27	16	0.7	0.8
3EL27NPT				
3IR27NPT				
3IL27NPT				

ER = Außen Rechts | External Right IR = Innen Rechts | Internal Right EL = Außen Links | External Left IL = Innen Links | Internal Left
 EL und IL auf Anfrage | EL and IL upon Request

NPT

EX-RH IN-RH
IN-LH EX-LH

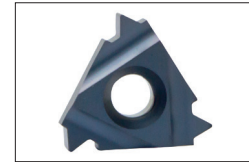
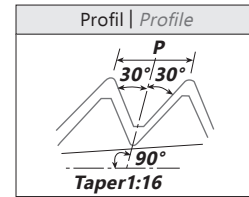
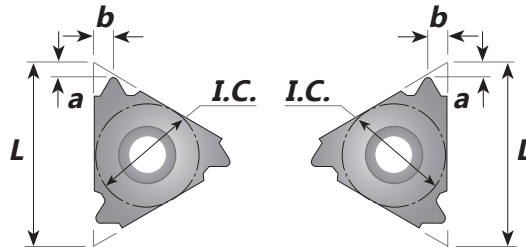

Artikelnummer (Item Number)	Steigung (Pitch)	Länge (Length) L	Maße in mm (Dimensions in mm)	
	Gänge/Zoll (TPI)		a	b
3ER18NPT	18	16	0.8	1.0
3EL18NPT				
3IR18NPT				
3IL18NPT				
3ER14NPT	14	16	0.9	1.2
3EL14NPT				
3IR14NPT				
3IL14NPT				
3ER11.5NPT	11.5	16	1.1	1.5
3EL11.5NPT				
3IR11.5NPT				
3IL11.5NPT				
3ER8NPT	8	16	1.3	1.8
3EL8NPT				
3IR8NPT				
3IL8NPT				

ER = Außen Rechts | External Right IR = Innen Rechts | Internal Right EL = Außen Links | External Left IL = Innen Links | Internal Left
 EL und IL auf Anfrage | EL and IL upon Request

Hartmetallqualitäten und Schnittgeschwindigkeiten siehe Seite 76-77 | For Carbide Grades and Cutting Speed see page 76-77

NPTF DRYSEAL

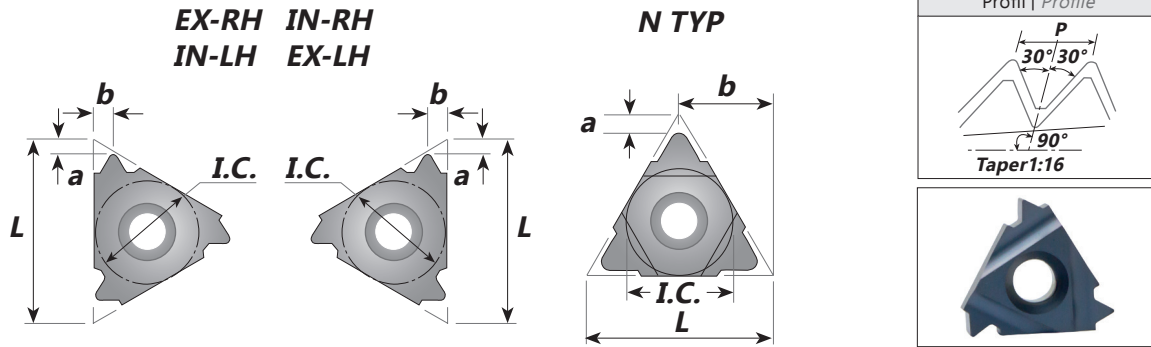

Artikelnummer (Item Number)	Steigung (Pitch)	Länge (Length)	Maße in mm (Dimensions in mm)	
	Gänge/Zoll (TPI)		a	b
0IR27NPTF	27	6	0.7	0.6
0IL27NPTF				
1IR27NPTF	27	8	0.6	0.6
1IL27NPTF				
1IR18NPTF	18	8	0.6	0.6
1IL18NPTF				
2ER27NPTF	27	11	0.7	0.7
2EL27NPTF				
2IR27NPTF				
2IL27NPTF				
2ER18NPTF	18	11	0.8	1.0
2EL18NPTF				
2IR18NPTF				
2IL18NPTF				
2ER14NPTF	14	11	0.8	1.0
2EL14NPTF				
2IR14NPTF				
2IL14NPTF				
2ER14NPTF	14	11	0.8	1.0
2EL14NPTF				
2IR14NPFT				
2IL14NPFT				
3ER27NPTF	18	16	0.8	1.0
3EL27NPTF				
3IR27NPTF				
3IL27NPTF				
3ER18NPTF	14	16	0.9	1.2
3EL18NPTF				
3IR18NPTF				
3IL18NPTF				

ER = Außen Rechts | External Right IR = Innen Rechts | Internal Right
EL und IL auf Anfrage | EL and IL upon Request

EL = Außen Links | External Left IL = Innen Links | Internal Left

NPTF DRYSEAL

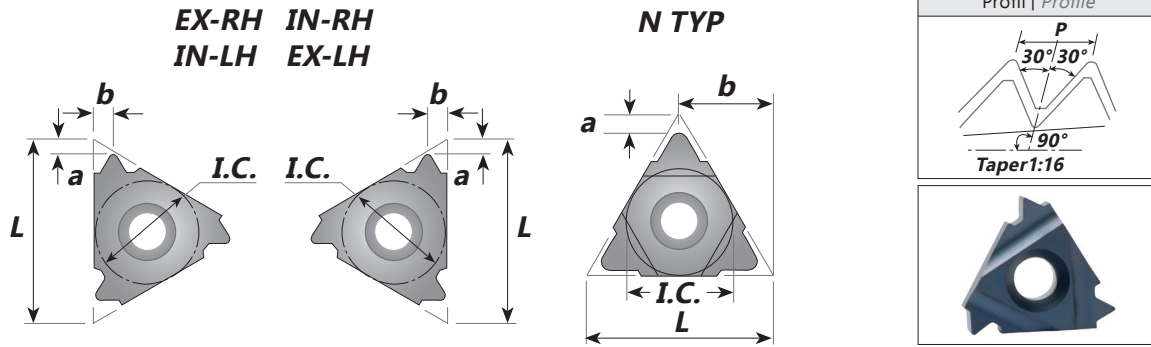

Artikelnummer (Item Number)	Steigung (Pitch) Gänge/Zoll (TPI)	Länge (Length) L	Maße in mm (Dimensions in mm)	
			a	b
3ER14NPTF	14	16	0.9	1.2
3EL14NPTF				
3IR14NPTF				
3IL14NPTF				
3ER11.5NPTF	11.5	16	1.1	1.5
3EL11.5NPTF				
3IR11.5NPTF				
3IL11.5NPTF				
3ER8NPTF	8	16	1.3	1.8
3EL8NPTF				
3IR8NPTF				
3IL8NPTF				

ER = Außen Rechts | *External Right*
EL und IL auf Anfrage | *EL and IL upon Request*

IR = Innen Rechts | *Internal Right*

EL = Außen Links | *External Left*

IL = Innen Links | *Internal Left*

BSPT

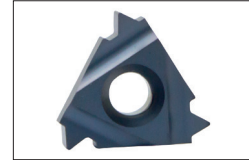
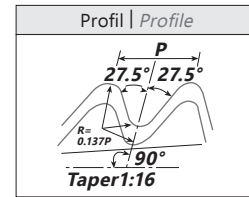
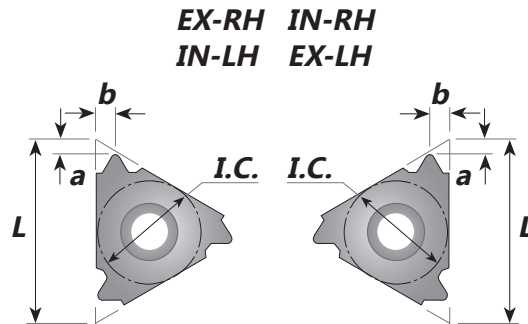

Artikelnummer (Item Number)	Steigung (Pitch)	Länge (Length) L	Maße in mm (Dimensions in mm)	
	Gänge/Zoll (TPI)		a	b
0IR28BSPT	28	6	0.7	0.6
0IL28BSPT				
1IR28BSPT	28	8	0.6	0.6
1IL28BSPT				
1IR19BSPT	19	8	0.6	0.6
1IL19BSPT				
2IR28BSPT	28	11	0.6	0.6
2IL28BSPT				
2IR19BSPT	19	11	0.8	0.9
2IL19BSPT				
2IR14BSPT	14	11	0.9	1.0
2IL14BSPT				
2IR11BSPT*	11	11	0.9	1.2
2IL11BSPT*				
3ER28BSPT	28	16	0.6	0.6
3IR28BSPT				
3EL28BSPT				
3IL28BSPT				
3ER19BSPT	19	16	0.8	0.9
3IR19BSPT				
3EL19BSPT				
3IL19BSPT				
3ER14BSPT	14	16	1.0	1.2
3IR14BSPT				
3EL14BSPT				
3IL14BSPT				
3ER11BSPT	11	16	1.1	1.5
3IR11BSPT				
3EL11BSPT				
3IL11BSPT				

ER = Außen Rechts | External Right IR = Innen Rechts | Internal Right EL = Außen Links | External Left IL = Innen Links | Internal Left
 EL und IL auf Anfrage | EL and IL upon Request

*Erfordert speziellen Halter oder einen selbstständig modifizierten Standardhalter | Special holder is required or standard holder can be modified by customer

ACME

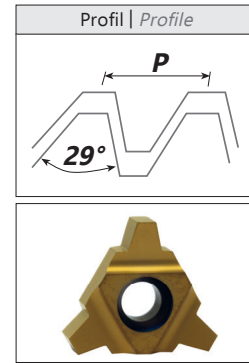
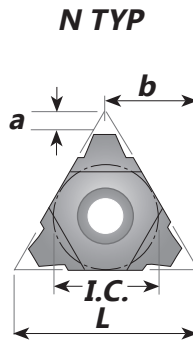
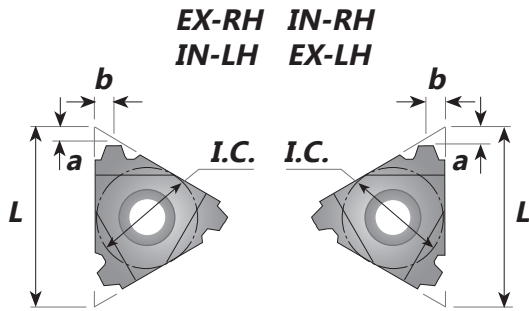

Artikelnummer (Item Number)	Steigung (Pitch)	Länge (Length) L	Maße in mm (Dimensions in mm)	
	Gänge/Zoll (TPI)		a	b
2ER16ACME	16	11	0.9	1.0
2IR16ACME				
2EL16ACME				
2IL16ACME				
3ER16ACME	16	16	0.9	1.0
3IR16ACME				
3EL16ACME				
3IL16ACME				
3ER14ACME	14	16	1.0	1.2
3IR14ACME				
3EL14ACME				
3IL14ACME				
3ER12ACME	12	16	1.1	1.2
3IR12ACME				
3EL12ACME				
3IL12ACME				
3ER10ACME	10	16	1.3	1.3
3IR10ACME				
3EL10ACME				
3IL10ACME				
3ER8ACME	8	16	1.5	1.5
3IR8ACME				
3EL8ACME				
3IL8ACME				

ER = Außen Rechts | External Right IR = Innen Rechts | Internal Right EL = Außen Links | External Left IL = Innen Links | Internal Left
 EL und IL auf Anfrage | EL and IL upon Request

ACME

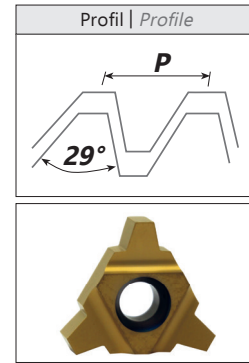
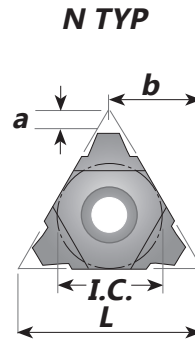
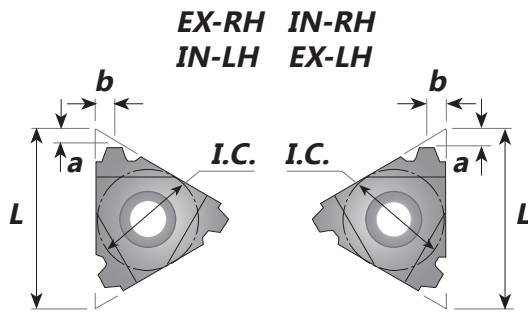

Artikelnummer (Item Number)	Steigung (Pitch)	Länge (Length) L	Maße in mm (Dimensions in mm)	
	Gänge/Zoll (TPI)		a	b
3ER6ACME*	6	16	1.7	1.8
3IR6ACME*				
3EL6ACME*				
3IL6ACME*				
4ER6ACME	6	22	1.8	2.1
4IR6ACME				
4EL6ACME				
4IL6ACME				
4ER5ACME	5	22	2.0	2.3
4IR5ACME				
4EL5ACME				
4IL5ACME				
4ER4ACME*	4	22	2.1	2.2
4IR4ACME*				
4EL4ACME*				
4IL4ACME*				
5ER4ACME	4	27	2.3	2.7
5IR4ACME				
5EL4ACME				
5IL4ACME				

ER = Außen Rechts | External Right IR = Innen Rechts | Internal Right EL = Außen Links | External Left IL = Innen Links | Internal Left
 EL und IL auf Anfrage | EL and IL upon Request

*Erfordert speziellen Halter oder einen selbstständig modifizierten Standardhalter | Special holder is required or standard holder can be modified by customer

STUB ACME

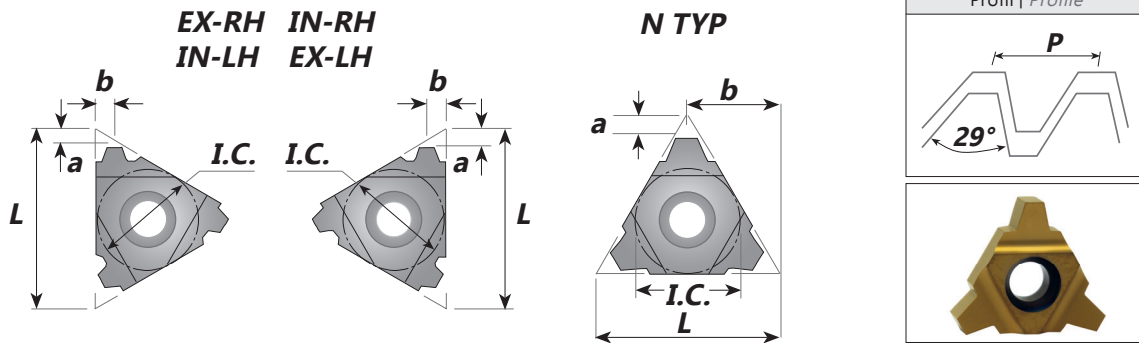

Artikelnummer (Item Number)	Steigung (Pitch)	Länge (Length) L	Maße in mm (Dimensions in mm)	
	Gänge/Zoll (TPI)		a	b
3IR16STACME*	16	8	0.6	0.6
3IL16STACME*				
2ER16STACME	16	11	1.0	1.0
2EL16STACME				
3ER16STACME	16	16	1.0	1.0
3IR16STACME				
3EL16STACME				
3IL16STACME	14	16	1.1	1.1
3ER14STACME				
3IR14STACME				
3EL14STACME				
3IL14STACME	12	16	1.2	1.2
3ER12STACME				
3IR12STACME				
3EL12STACME				
3IL12STACME	10	16	1.3	1.3
3ER10STACME				
3EL10STACME				
3IR10STACME				
3IL10STACME	8	16	1.5	1.5
3ER8STACME				
3IR8STACME				
3EL8STACME				
3IL8STACME				

ER = Außen Rechts | *External Right* IR = Innen Rechts | *Internal Right* EL = Außen Links | *External Left* IL = Innen Links | *Internal Left*
 EL und IL auf Anfrage | *EL and IL upon Request*

*Erfordert speziellen Halter oder einen selbstständig modifizierten Standardhalter | *pecial holder is required or standard holder can be modified by customer*

Hartmetallqualitäten und Schnittgeschwindigkeiten siehe Seite 76-77 | *For Carbide Grades and Cutting Speed see page 76-77*

STUB ACME

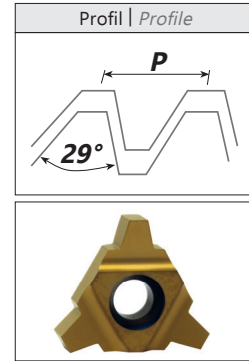
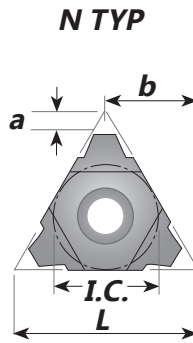
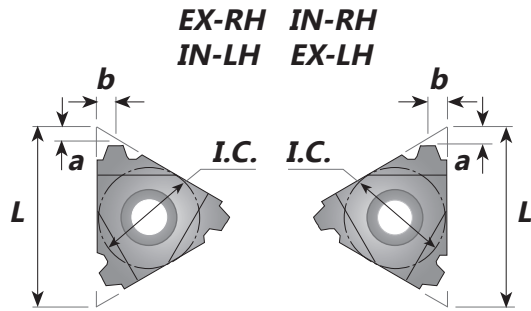

Artikelnummer (Item Number)	Steigung (Pitch) Gänge/Zoll (TPI)	Länge (Length) L	Maße in mm (Dimensions in mm)	
			a	b
3ER6STACME	6	16	1.8	1.8
3IR6STACME				
3EL6STACME				
3IL6STACME				
4ER5STACME	5	22	2.0	2.3
4IR5STACME				
4EL5STACME				
4IL5STACME				
4ER4STACME	4	22	2.3	2.4
4IR4STACME				
4EL4STACME				
4IL4STACME				
5ER4STACME	4	27	2.3	2.4
5IR4STACME				
5EL4STACME				
5IL4STACME				
5ER3STACME	3	27	3.3	11.0
5IR3STACME				
5EL3STACME				
5IL3STACME				

ER = Außen Rechts | External Right IR = Innen Rechts | Internal Right EL = Außen Links | External Left IL = Innen Links | Internal Left
EL und IL auf Anfrage | EL and IL upon Request

TRAPEZ DIN 103

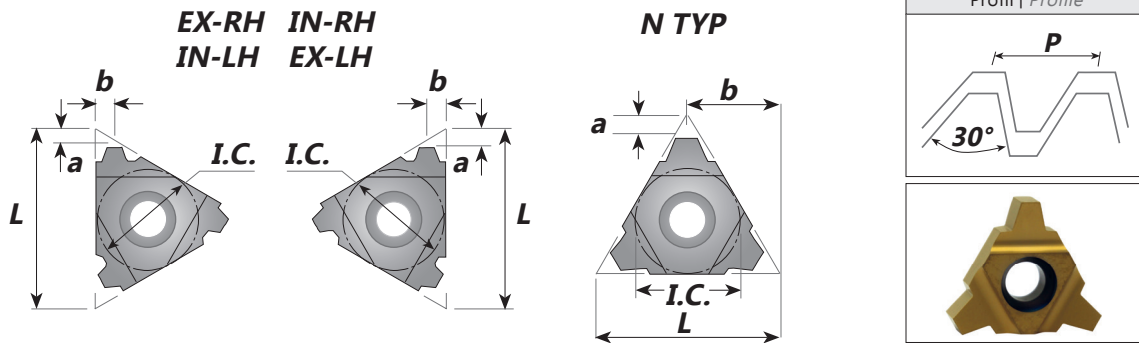

Artikelnummer (Item Number)	Steigung (Pitch) Gänge/Zoll (TPI)	Länge (Length) L	Maße in mm (Dimensions in mm)	
			a	b
1IR1.5TR*	1.5	8	0.6	0.6
1IL1.5TR*				
3ER1.5TR	1.5	16	1.0	1.1
3EL1.5TR				
3ER2TR	2.0	16	1.0	1.3
3IR2TR				
3EL2TR				
3IL2TR	3.0	16	1.3	1.5
3ER3TR				
3IR3TR				
3EL3TR	4.0	16	1.3	1.5
3IL3TR				
(1)3ER4TR				
(2)3IR4TR	4.0	16	1.3	1.5
(1)3EL4TR				
(2)3IL4TR	4.0	22	1.8	1.9
4ER4TR				
4IR4TR				
4EL4TR				
4IL4TR	5.0	22	2.0	2.4
4ER5TR				
4IR5TR				
4EL5TR				
4IL5TR				

ER = Außen Rechts | External Right IR = Innen Rechts | Internal Right EL = Außen Links | External Left IL = Innen Links | Internal Left

EL und IL auf Anfrage | EL and IL upon Request

*Eine Schneidkante | One cutting edge

**Ausschließlich mit Halter IR14-3NCO, IL14-3NCO von Seite 72 zu verwenden | To be used only with holder IR14-3NCO, IL14-3NCO on page 72

(1) erfordert speziellen Halter oder einen selbstständig modifizierten Standardhalter | Special holder is required or standard holder can be modified by customer

(2) Ein Sonderhalter wird benötigt oder ein Standardhalter (IR12-3B, IL12-3B, IR14-3B, IL14-3B) muss vom Kunden modifiziert werden

(2) Special holder is required or standard holder can be modified by customer or to be used with holders: (IR12-3B, IL12-3B, IR14-3B, IL14-3B)

(3) Ausschließlich für TR40x7. Passender Halter IR25-4NCO, IL25-4NCO | Only for Tr40x7.0. To be used only with holder IR25-4NCO, IL25-4NCO

TRAPEZ DIN 103

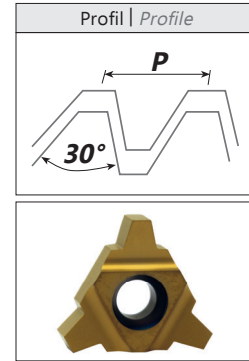
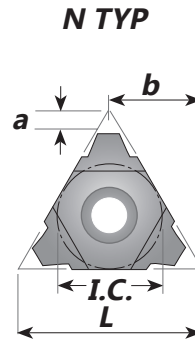
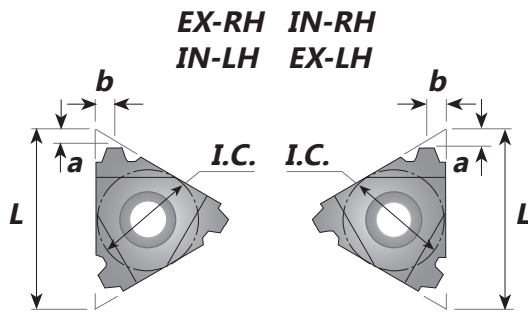

Artikelnummer (Item Number)	Steigung (Pitch) Gänge/Zoll (TPI)	Länge (Length) L	Maße in mm (Dimensions in mm)	
			a	b
⁽¹⁾ 4ER6TR	6.0	22	2.0	2.4
⁽¹⁾ 4IR6TR				
⁽¹⁾ 4EL6TR				
⁽¹⁾ 4IL6TR				
4NER/L6TR	6.0	22N	2.0	11.0
4NIR/L6TR				
4NER/L7TR	7.0	22N	2.3	11.0
4NIR/L7TR				
⁽³⁾ 4NIR/L7TR40	7.0	22N	2.6	11.0
4NER/L8TR	8.0	22N	2.5	11.0
4NIR/L8TR				
5ER6TR	6.0	27	2.3	2.7
5IR6TR				
5EL6TR				
5IL6TR				
5ER7TR	7.0	27	2.2	2.6
5IR7TR				
5EL7TR				
5IL7TR				
5NER/L8TR	8.0	27N	2.5	13.7
5NIR/L8TR				
5NER/L9TR	9.0	27N	3.0	13.7
5NIR/L9TR				
5NER/L10TR*	10.0	27N	3.9	16.9

ER = Außen Rechts | External Right IR = Innen Rechts | Internal Right EL = Außen Links | External Left IL = Innen Links | Internal Left

EL und IL auf Anfrage | EL and IL upon Request

*Eine Schneidkante | One cutting edge

**Ausschließlich mit Halter IR14-3NCO, IL14-3NCO von Seite 72 zu verwenden | To be used only with holder IR14-3NCO, IL14-3NCO on page 72

(1) erfordert speziellen Halter oder einen selbstständig modifizierten Standardhalter | Special holder is required or standard holder can be modified by customer

(2) Ein Sonderhalter wird benötigt oder ein Standardhalter (IR12-3B, IL12-3B, IR14-3B, IL14-3B) muss vom Kunden modifiziert werden

(2) Special holder is required or standard holder can be modified by customer or to be used with holders: (IR12-3B, IL12-3B, IR14-3B, IL14-3B)

(3) Ausschließlich für TR40x7. Passender Halter IR25-4NCO, IL25-4NCO | Only for Tr40x7.0. To be used only with holder IR25-4NCO, IL25-4NCO

Hartmetallqualitäten und Schnittgeschwindigkeiten siehe Seite 76-77 | For Carbide Grades and Cutting Speed see page 76-77

PG DIN 40430

EX-RH IN-RH

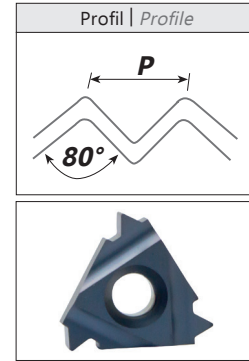
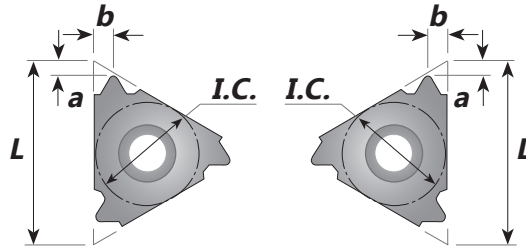

Artikelnummer (Item Number)	Steigung (Pitch)	Länge (Length)	Maße in mm (Dimensions in mm)	
	Gänge/Zoll (TPI)		a	b
1IR20PG (PG 7)	20	8	0.6	0.7
2IR18PG (PG 9)	18	11	0.8	0.9
3ER20PG (PG 7)	20	16	0.7	0.8
3ER18PG (PG 9, 11, 13.5, 16)	18	16	0.8	0.9
3IR18PG (PG 11, 13.5, 16)				
3ER16PG (PG 21, 29, 36, 42, 48)	16	16	0.8	1.0
3IR16PG (PG 21, 29, 36, 42, 48)				

ER = Außen Rechts | External Right IR = Innen Rechts | Internal Right EL = Außen Links | External Left IL = Innen Links | Internal Left
 EL und IL auf Anfrage | EL and IL upon Request

SÄGENGEWINDE / SAGENGEWINDE DIN 513

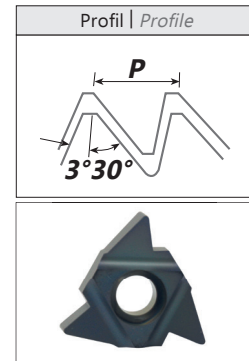
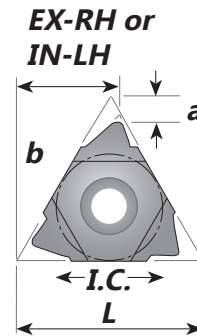
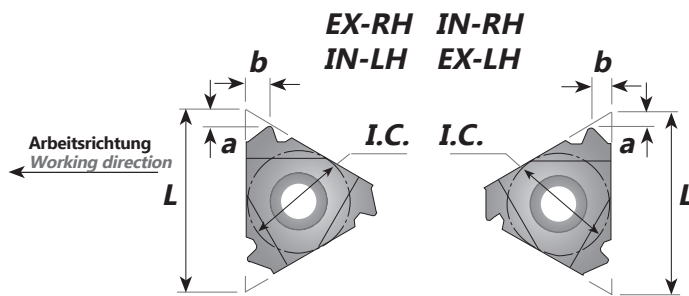

Artikelnummer (Item Number)	Steigung (Pitch) mm	Länge (Length) L	Maße in mm (Dimensions in mm)	
			a	b
3ER2SAGE	2.0	16	1.1	1.6
3EL2SAGE				
3IR2SAGE			1.2	1.7
3IL2SAGE				
4ER3SAGE	3.0	22	1.5	2.4
4EL3SAGE				
4IR3SAGE			1.9	2.9
4IL3SAGE				
4ER4SAGE	4.0	22N	1.9	3.1
4EL4SAGE				
4IR4SAGE			2.3	3.5
4IL4SAGE				
4NER5SAGE	5.0*	22N	1.2	11.7
4NEL5SAGE				
4NIR5SAGE			1.9	11.7
4NIL5SAGE				
4NER6SAGE	6.0*	22N	1.2	11.7
4NEL6SAGE				
4NIR6SAGE			2.1	11.9
4NIL6SAGE				

ER = Außen Rechts | External Right IR = Innen Rechts | Internal Right EL = Außen Links | External Left IL = Innen Links | Internal Left
 EL und IL auf Anfrage | EL and IL upon Request

*Erfordert spezielle Unterlegplatte | Requires a special anvil: AER4N-1.5SAGE, AEL4N-1.5SAGE, AIR4N-1.5SAGE, AIL4N-1.5SAGE

Wichtiger Hinweis: In der Standardausführung ist die Flanke mit dem großen Winkel die Leitkante. Falls anders gewünscht, bitte bei Bestellung angeben.

Important Note: In standard execution, the flank with the large angle is the leading edge. If otherwise required, please specify in your order.

Hartmetallqualitäten und Schnittgeschwindigkeiten siehe Seite 76-77 | For Carbide Grades and Cutting Speed see page 76-77

RUND I ROUND DIN 405

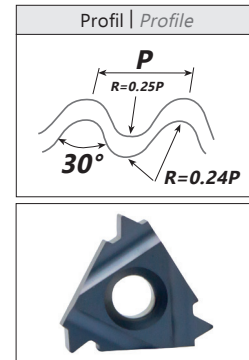
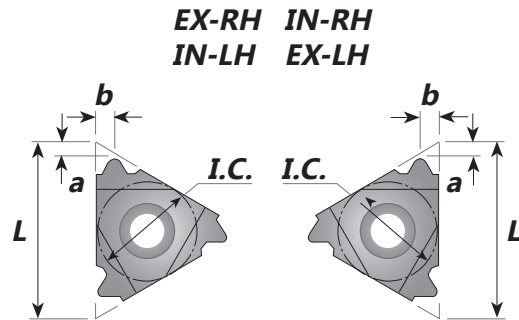

Artikelnummer (Item Number)	Steigung (Pitch) Gänge/Zoll (TPI)	Länge (Length) L	Maße in mm (Dimensions in mm)	
			a	b
3ER10RD	10	16	1.1	1.2
3EL10RD				
3IR10RD			1.1	1.2
3IL10RD				
3ER8RD	8	16	1.4	1.3
3EL8RD				
3IR8RD			1.4	1.4
3IL8RD				
3ER6RD	6	16	1.5	1.7
3EL6RD				
3IR6RD			1.4	1.5
3IL6RD				
4ER6RD	6	22	1.5	1.7
4EL6RD				
4IR6RD				
4IL6RD				
4ER4RD	4	22	2.2	2.3
4EL4RD				
4IR4RD				
4IL4RD				
5ER4RD	4	27	2.2	2.3
5EL4RD				
5IR4RD				
5IL4RD				

ER = Außen Rechts | External Right IR = Innen Rechts | Internal Right EL = Außen Links | External Left IL = Innen Links | Internal Left
 EL und IL auf Anfrage | EL and IL upon Request

Hartmetallqualitäten und Schnittgeschwindigkeiten siehe Seite 76-77 | For Carbide Grades and Cutting Speed see page 76-77

RUND I ROUND DIN 20400

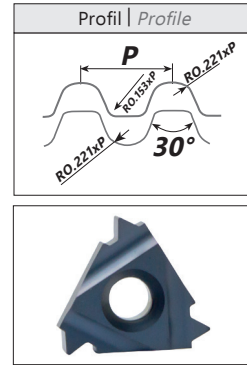
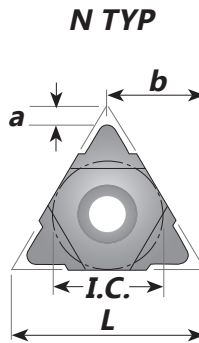
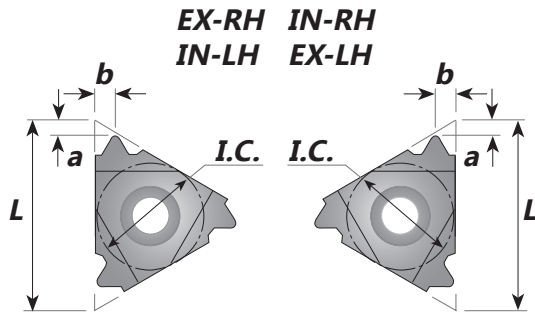

Artikelnummer (Item Number)	Steigung (Pitch)	Länge (Length)	Maße in mm (Dimensions in mm)	
	mm		L	a
4ER4.0RD20400	4.0	22	1.4	1.4
4IR4.0RD20400				
4ER5.0RD20400	5.0	22	1.7	1.8
4IR5.0RD20400				
4ER6.0RD20400	6.0	22	1.7	2.0
4IR6.0RD20400				

ER = Außen Rechts | *External Right* IR = Innen Rechts | *Internal Right* EL = Außen Links | *External Left* IL = Innen Links | *Internal Left*
 EL und IL auf Anfrage | *EL and IL upon Request*

UNJ UNJC, UNJF, UNJEF, UNJS

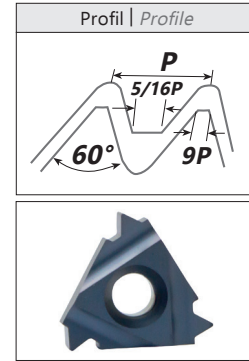
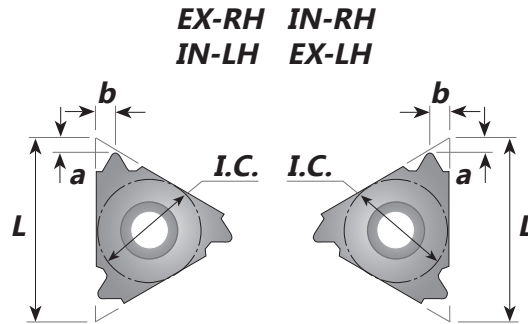

Artikelnummer (Item Number)	Steigung (Pitch) Gänge/Zoll (TPI)	Länge (Length) L	Maße in mm (Dimensions in mm)	
			a	b
2ER48UNJ	48	11	0.6	0.6
2EL48UNJ				
2IR48UNJ				
2IL48UNJ				
2ER44UNJ	44	11	0.6	0.6
2EL44UNJ				
2IR44UNJ				
2IL44UNJ				
2ER40UNJ	40	11	0.6	0.6
2EL40UNJ				
2IR40UNJ				
2IL40UNJ				
2ER36UNJ	36	11	0.6	0.6
2EL36UNJ				
2IR36UNJ				
2IL36UNJ				
2ER32UNJ	32	11	0.6	0.6
2EL32UNJ				
2IR32UNJ				
2IL32UNJ				
2ER28UNJ	28	11	0.6	0.6
2EL28UNJ				
2IR28UNJ				
2IL28UNJ				
2ER24UNJ	24	11	0.7	0.8
2EL24UNJ				
2IR24UNJ				
2IL24UNJ				

ER = Außen Rechts | External Right IR = Innen Rechts | Internal Right EL = Außen Links | External Left IL = Innen Links | Internal Left
EL und IL auf Anfrage | EL and IL upon Request

Hartmetallqualitäten und Schnittgeschwindigkeiten siehe Seite 76-77 | For Carbide Grades and Cutting Speed see page 76-77

UNJ UNJC, UNJF, UNJEF, UNJS

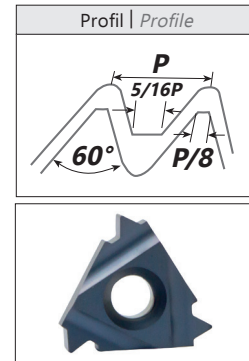
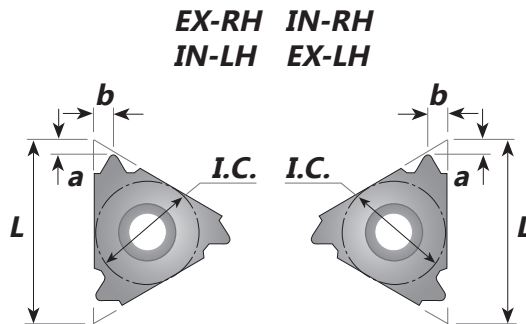

Artikelnummer (Item Number)	Steigung (Pitch)	Länge (Length) L	Maße in mm (Dimensions in mm)	
	Gänge/Zoll (TPI)		a	b
2ER20UNJ	20	11	0.8	0.9
2EL20UNJ				
2IR20UNJ				
2IL20UNJ				
2ER18UNJ	18	11	0.8	1.0
2EL18UNJ				
2IR18UNJ				
2IL18UNJ				
2ER16UNJ	16	11	0.8	1.0
2EL16UNJ				
2IR16UNJ				
2IL16UNJ				
2ER14UNJ	14	11	0.9	1.0
2EL14UNJ				
2IR14UNJ				
2IL14UNJ				
3ER48UNJ	48	16	0.6	0.6
3EL48UNJ				
3IR48UNJ				
3IL48UNJ				
3ER44UNJ	44	16	0.6	0.6
3EL44UNJ				
3IR44UNJ				
3IL44UNJ				
3ER40UNJ	40	16	0.6	0.6
3EL40UNJ				
3IR40UNJ				
3IL40UNJ				

ER = Außen Rechts | External Right IR = Innen Rechts | Internal Right EL = Außen Links | External Left IL = Innen Links | Internal Left
EL und IL auf Anfrage | EL and IL upon Request

Hartmetallqualitäten und Schnittgeschwindigkeiten siehe Seite 76-77 | For Carbide Grades and Cutting Speed see page 76-77

UNJ UNJC, UNJF, UNJEF, UNJS

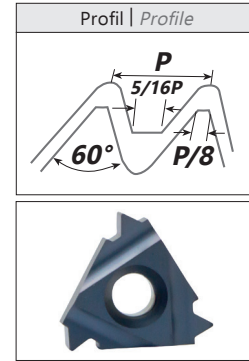
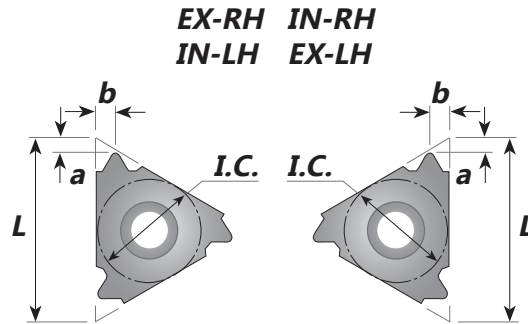

Artikelnummer (Item Number)	Steigung (Pitch) Gänge/Zoll (TPI)	Länge (Length) L	Maße in mm (Dimensions in mm)	
			a	b
3ER36UNJ	36	16	0.6	0.6
3EL36UNJ				
3IR36UNJ				
3IL36UNJ				
3ER32UNJ	32	16	0.6	0.6
3EL32UNJ				
3IR32UNJ				
3IL32UNJ				
3ER28UNJ	28	16	0.6	0.6
3EL28UNJ				
3IR28UNJ				
3IL28UNJ				
3ER24UNJ	24	16	0.7	0.8
3EL24UNJ				
3IR24UNJ				
3IL24UNJ				
3ER20UNJ	20	16	0.8	0.9
3EL20UNJ				
3IR20UNJ				
3IL20UNJ				
3ER18UNJ	18	16	0.8	1.0
3EL18UNJ				
3IR18UNJ				
3IL18UNJ				
3ER16UNJ	16	16	0.8	1.0
3EL16UNJ				
3IR16UNJ				
3IL16UNJ				

ER = Außen Rechts | External Right IR = Innen Rechts | Internal Right EL = Außen Links | External Left IL = Innen Links | Internal Left
EL und IL auf Anfrage | EL and IL upon Request

Hartmetallqualitäten und Schnittgeschwindigkeiten siehe Seite 76-77 | For Carbide Grades and Cutting Speed see page 76-77

UNJ UNJC, UNJF, UNJEF, UNJS

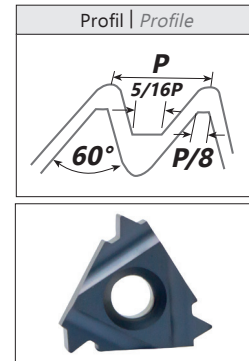
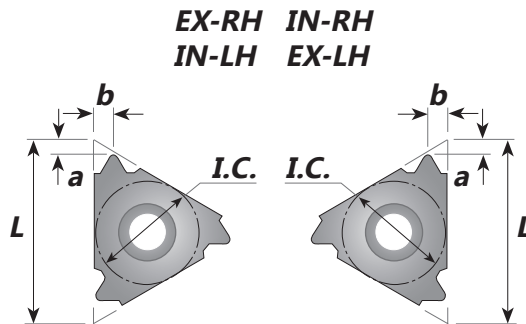

Artikelnummer (Item Number)	Steigung (Pitch)	Länge (Length) L	Maße in mm (Dimensions in mm)	
	Gänge/Zoll (TPI)		a	b
3ER14UNJ	14	16	1.0	1.2
3EL14UNJ				
3IR14UNJ				
3IL14UNJ				
3ER13UNJ	13	16	1.0	1.3
3EL13UNJ				
3IR13UNJ				
3IL13UNJ				
3ER12UNJ	12	16	1.1	1.4
3EL12UNJ				
3IR12UNJ				
3IL12UNJ				
3ER11UNJ	11	16	1.1	1.5
3EL11UNJ				
3IR11UNJ				
3IL11UNJ				
3ER10UNJ	10	16	1.1	1.5
3EL10UNJ				
3IR10UNJ				
3IL10UNJ				
3ER9UNJ	9	16	1.2	1.6
3EL9UNJ				
3IR9UNJ				
3IL9UNJ				
3ER8UNJ	8	16	1.2	1.6
3EL8UNJ				
3IR8UNJ				
3IL8UNJ				

ER = Außen Rechts | External Right IR = Innen Rechts | Internal Right EL = Außen Links | External Left IL = Innen Links | Internal Left
 EL und IL auf Anfrage | EL and IL upon Request

Hartmetallqualitäten und Schnittgeschwindigkeiten siehe Seite 76-77 | For Carbide Grades and Cutting Speed see page 76-77

MJ ISO 5855

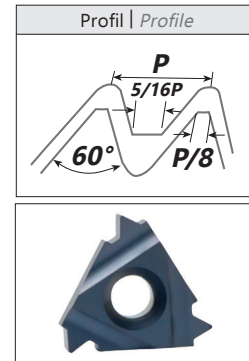
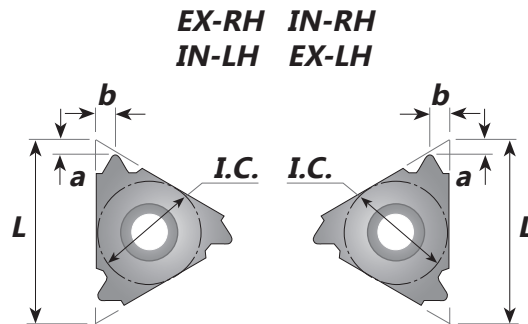

Artikelnummer (Item Number)	Steigung (Pitch) mm	Länge (Length) L	Maße in mm (Dimensions in mm)	
			a	b
2IR1.0MJ	1.0	11	0.7	0.8
2IR1.25MJ	1.25	11	0.8	0.9
2IR1.5MJ	1.5	11	0.8	1.0
2IR2.0MJ	2.0	11	0.9	1.0
3ER1.0MJ	1.0	16	0.7	0.8
3IR1.0MJ				
3ER1.25MJ	1.25	16	0.8	0.9
3IR1.25MJ				
3ER1.5MJ	1.5	16	0.8	2.0
3IR1.5MJ				
3ER2.0MJ	2.0	16	1.0	1.3
3IR2.0MJ				

ER = Außen Rechts | *External Right* IR = Innen Rechts | *Internal Right* EL = Außen Links | *External Left* IL = Innen Links | *Internal Left*
 EL und IL auf Anfrage | *EL and IL upon Request*

AMERICAN BUTTRESS

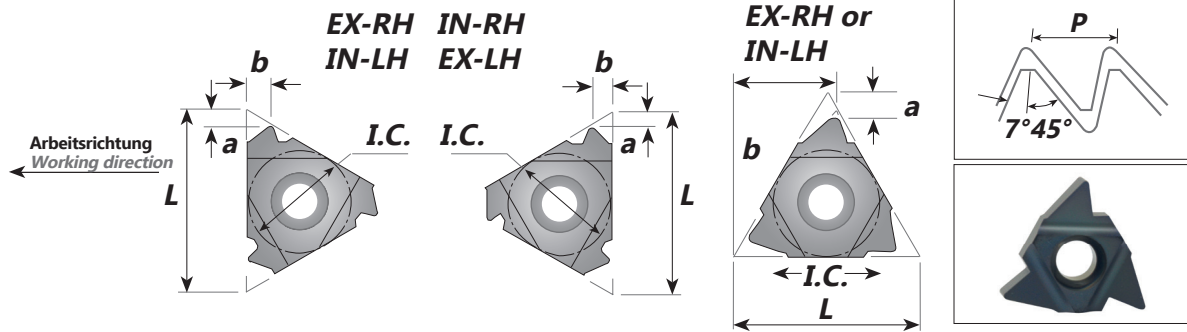

Artikelnummer (Item Number)	Steigung (Pitch)	Länge (Length) L	Maße in mm (Dimensions in mm)	
	Gänge/Zoll (TPI)		a	b
2ER20ABUT	20	11	1.0	1.3
2EL20ABUT				
2IR20ABUT				
2IL20ABUT				
2ER16ABUT	16	11	1.0	1.5
2EL16ABUT				
2IR16ABUT				
2IL16ABUT				
3ER20ABUT	20	16	1.0	1.3
3EL20ABUT				
3IR20ABUT				
3IL20ABUT				
3ER16ABUT	16	16	1.0	1.5
3EL16ABUT				
3IR16ABUT				
3IL16ABUT				
3ER12ABUT	12	16	1.4	2.0
3EL12ABUT				
3IR12ABUT				
3IL12ABUT				
3ER10ABUT	10	16	1.5	2.3
3EL10ABUT				
3IR10ABUT				
3IL10ABUT				

ER = Außen Rechts | External Right IR = Innen Rechts | Internal Right EL = Außen Links | External Left IL = Innen Links | Internal Left
EL und IL auf Anfrage | EL and IL upon Request

Wichtiger Hinweis: In der Standardausführung ist die Flanke mit dem großen Winkel die Leitkante. Falls anders gewünscht, bitte bei Bestellung angeben.
Important Note: In standard execution, the flank with the large angle is the leading edge. If otherwise required, please specify in your order.

Hartmetallqualitäten und Schnittgeschwindigkeiten siehe Seite 76-77 | For Carbide Grades and Cutting Speed see page 76-77

AMERICAN BUTTRESS

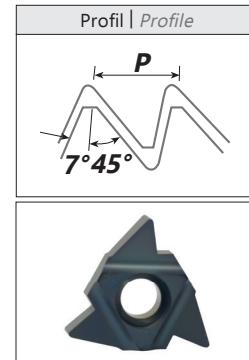
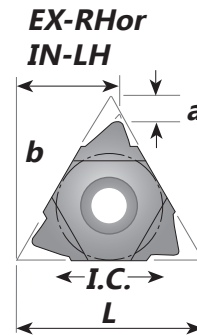
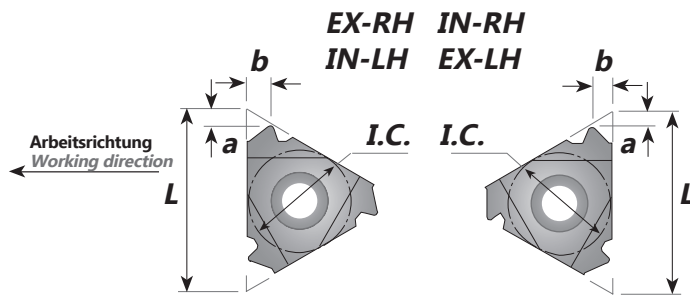

Artikelnummer (Item Number)	Steigung (Pitch)	Länge (Length) L	Maße in mm (Dimensions in mm)	
	Gänge/Zoll (TPI)		a	b
4ER8ABUT	8	22	2.1	3.3
4EL8ABUT				
4IR8ABUT				
4IL8ABUT				
4ER6ABUT	6	22	2.1	3.4
4EL6ABUT				
4IR6ABUT				
4IL6ABUT				
4NER4ABUT	4	22N	2.3	11.7
4NEL4ABUT				
4NIR4ABUT				
4NIL4ABUT				
5NER3ABUT	3	27N	3.1	11.7
5NEL3ABUT				
5NIR3ABUT				
5NIL3ABUT				

ER = Außen Rechts | External Right IR = Innen Rechts | Internal Right EL = Außen Links | External Left IL = Innen Links | Internal Left
 EL und IL auf Anfrage | EL and IL upon Request

Wichtiger Hinweis: In der Standardausführung ist die Flanke mit dem großen Winkel die Leitkante. Falls anders gewünscht, bitte bei Bestellung angeben.
Important Note: In standard execution, the flank with the large angle is the leading edge. If otherwise required, please specify in your order.

Hartmetallqualitäten und Schnittgeschwindigkeiten siehe Seite 76-77 | For Carbide Grades and Cutting Speed see page 76-77

ÖLGEWINDE API RUND / OIL THREADS API ROUND

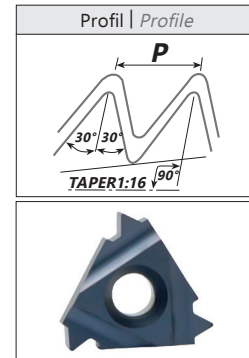
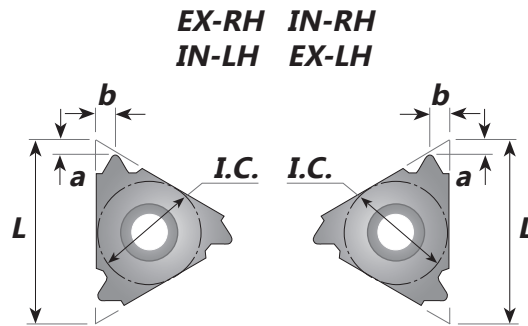

Artikelnummer (Item Number)	Steigung (Pitch)	Länge (Length)	Konus (Taper)	Maße in mm (Dimensions in mm)	
	Gänge/Zoll (TPI)			IPF	a
3ER10APIRD	10	16	0.75	1.5	1.4
3IR10APIRD					
3ER8APIRD	8	16	0.75	1.3	1.6
3IR8APIRD					

ÖLGEWINDE MEHRZAHN / OIL THREADS MULTI-TOOTH

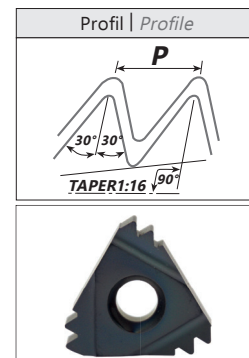
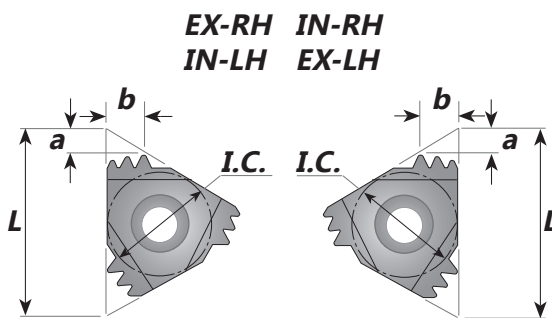

Artikelnummer (Item Number)	Steigung (Pitch)	Länge (Length)	Anzahl der Zähne (Number of Teeth)	Maße in mm (Dimensions in mm)	
	TPI			a	b
⁽¹⁾ 4ER10APIRD2M	10	22	2	2.4	3.7
⁽²⁾ 4IR10APIRD2M					
⁽³⁾ 5ER10APIRD3M	10	27	3	3.8	6.2
⁽⁴⁾ 5IR10APIRD3M					
⁽³⁾ 5ER8APIRD2M	8	27	2	3.0	4.5
⁽⁴⁾ 5IR8APIRD2M					

Unterlegplatte | Anvil: ⁽¹⁾AE4M, ⁽²⁾AI4M, ⁽³⁾AE5M, ⁽⁴⁾AI5M

Zustellungswerte für Mehrzahnplatten siehe Seite 78 | For recommended number of passes see page 78

ÖLGEWINDE / OIL THREADS

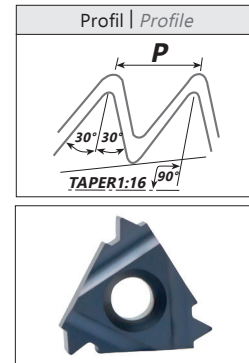
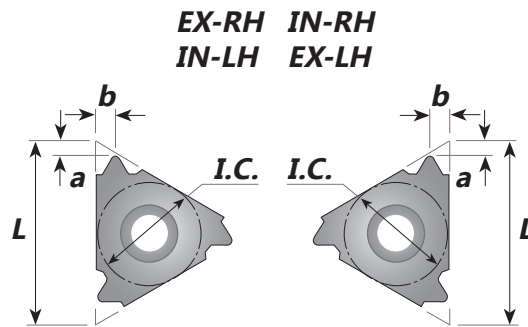

V-0.040

Artikelnummer (Item Number)	Steigung (Pitch)	Länge (Length)	Konus (Taper)	Maße in mm (Dimensions in mm)		Anschlußnr. oder Größe (Connection No. or Size)
	TPI		IPF	a	b	
4ER5API403	5	22	3	1.8	2.5	23/8-41/2REG
4IR5API403						

V-0.038R

5ER4API382	4	27	2	2.1	2.8	NC23-NC50
5IR4API382						
5ER4API383	4	27	3	2.1	2.8	NC56-NC77
5IR4API383						

V-0.050

5ER4API502	4	27	2	2.0	3.0	65/8REG
5IR4API502						
5ER4API503	4	27	3	2.0	3.0	51/12,75/8, 55/8REG
5IR4API503						

V-0.055 Macaroni Tubing (MT), American Macaroni Tubing (AMT), American Mining Macaroni Tubing (AMMT)

4ER6API551.5	6	22	1.5	2.0	1.7	NC10,NC12, NC13,NC16
3IR6API551.5	6	16	1.5	2.0	1.7	NC10,NC12, NC13*
4IR6API551.5	6	22	1.5	2.0	1.7	NC16**

*für NC10, N12 ist der Halter IR16-3CB zu benutzen, für N13 sind die Halter IR20-3, IR20-3B oder IR20-3CB zu benutzen

**für NC16 ist der Halter IR25-4 zu benutzen

*for NC10, NC12 use holder IR16-3CB, for NC13 use holders IR20-3/IR20-3B/IR20-3CB

**for NC16 use holder IR25-4

Hartmetallqualitäten und Schnittgeschwindigkeiten siehe Seite 76-77 | For Carbide Grades and Cutting Speed see page 76-77

ÖLGEWINDE API / OIL THREADS

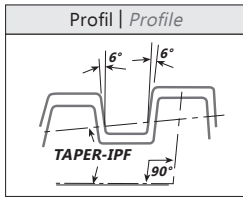

Extreme-Line Casing

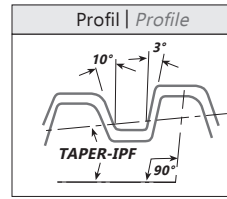

Buttress Casing

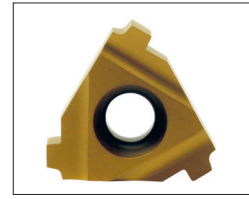

Extreme-Line Casing

Artikelnummer (Item Number)	Steigung (Pitch)	Länge (Length)	Konus (Taper)	Maße in mm (Dimensions in mm)		Anschlußnr. oder Größe (Connection No. or Size)
	TPI			L	IPF	
4ER6EL1.5	6	22	1.50	1.9	1.9	5-75/8
4IR6EL1.5						
4ER5EL1.25	5	22	1.25	2.4	2.3	85/8-103/4
4IR5EL1.25						

Buttress Casing

4ER5BUT0.75	5	22	0.75	2.2	2.4	41/2-133/8
4IR5BUT0.75						
4ER5BUT1.0	5	22	1.00	2.3	2.4	16-20
4IR5BUT1.0						





2

GEWINDEDREHHALTER

THREAD TURNING TOOLHOLDERS

THREAD TURNING

PRODUKT BEZEICHNUNG | PRODUCT DESIGNATION

BEISPIEL | EXAMPLE: AR20-3

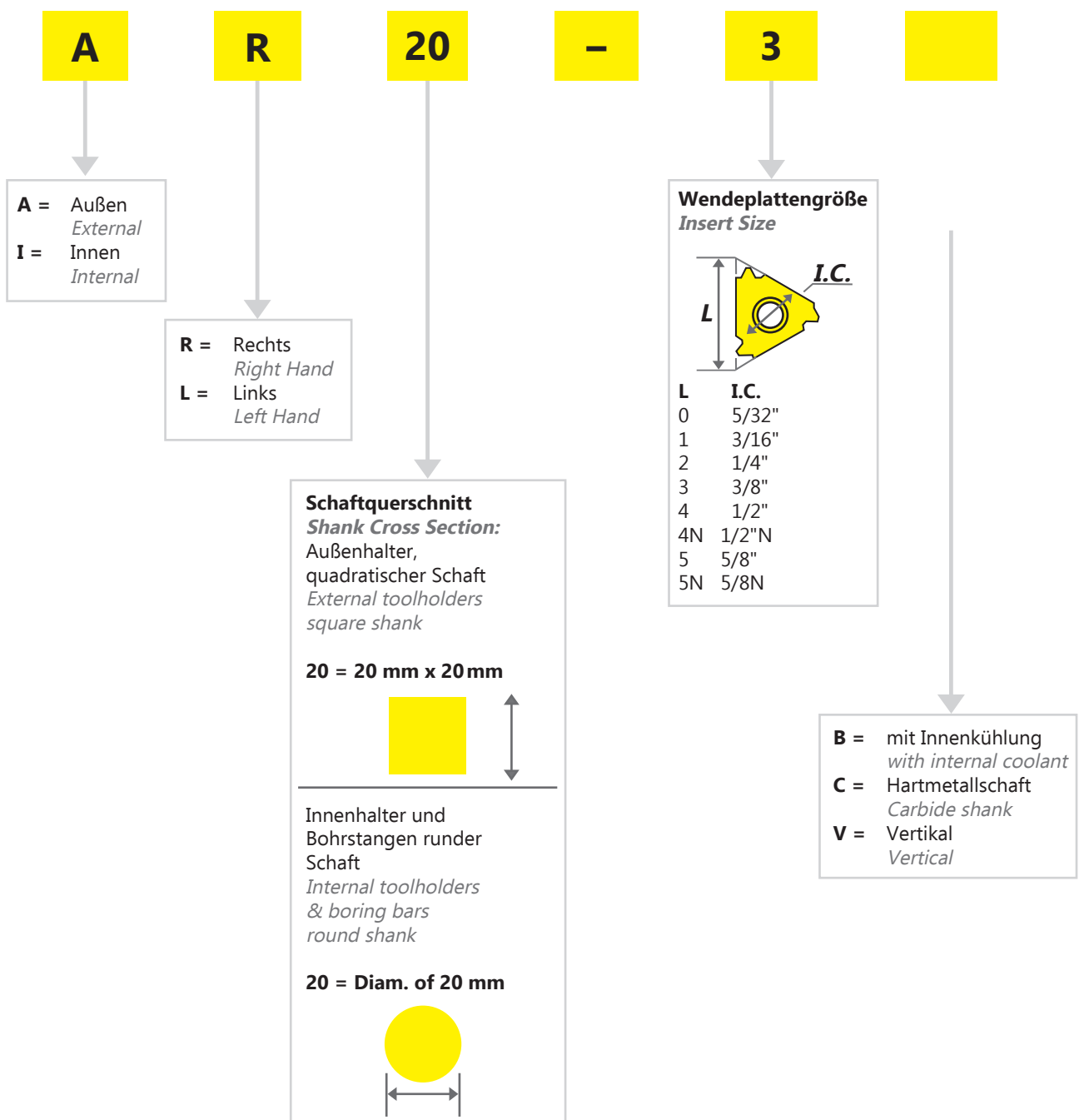

AUSSENKLEMMHALTER / EXTERNAL TOOLHOLDERS



Artikelnummer (Item Number)	B = H	Länge (Length) L	F	Wende- platten- größe (Insert Size)	Torx Schlüssel (Torx Key)	Schraube Gewinde- platte (Insert Screw)	Schraube Unterleg- platte (Anvil Screw)	RH Unterleg- platte (Anvil Screw)	LH Unterleg- platte (Anvil Screw)
*AR08-2	8	100	11	11	TX11	S2	-	-	-
*AR10-2	10	100	11	11	TX11	S2	-	-	-
*AR10-2M	10	150	11	11	TX11	S2	-	-	-
*AR12-2	12	125	12	11	TX11	S2	-	-	-
*AR12-2M	12	150	12	11	TX11	S2	-	-	-
AR12-3	12	80	16	16	TX16	S3	A3	AE3	AI3
AR16-3	16	100	16	16	TX16	S3	A3	AE3	AI3
AR20-3	20	125	20	16	TX16	S3	A3	AE3	AI3
AR25-3	25	150	25	16	TX16	S3	A3	AE3	AI3
AR32-3	32	170	32	16	TX16	S3	A3	AE3	AI3
AR25-4	25	150	25	22	TX22	S4	A4	AE4	AI4
AR32-4	32	170	32	22	TX22	S4	A4	AE4	AI4
AR40-4	40	200	40	22	TX22	S4	A4	AE4	AI4
AR25-M4N	25	150	28	22N	TX22	S4	A4	AE4N	AI4N
AR32-P4N	32	170	32	22N	TX22	S4	A4	AE4N	AI4N
AR40-R4N	40	200	40	22N	TX22	S4	A4	AE4N	AI4N
AR25-M5	25	150	32	27	TX27	S5	A5	AE5	AI5
AR32-P5	32	170	32	27	TX27	S5	A5	AE5	AI5
AR40-R5	40	200	40	27	TX27	S5	A5	AE5	AI5
AR25-M5N	25	150	32	27N	TX27	S5	A5	AE5N	AI5N
AR32-P5N	32	170	32	27N	TX27	S5	A5	AE5N	AI5N
AR40-R5N	40	200	40	27N	TX27	S5	A5	AE5N	AI5N

*Klemmhalter ohne Unterlegplatte | Toolholders without anvil

Für **Linke Ausführung** schreiben Sie **AL** statt **AR** | For **Left Hand** toolholders specify **AL** instead of **AR**

Die Klemmhalter werden mit einem Steigungswinkel von 1.5° hergestellt. Um den Steigungswinkel zu ermitteln, verwenden Sie bitte die Diagramme im technischen Teil (Seite 73).

Toolholders are made with a 1.5° helix angle. For other helix angles please refer to helix angle chart (page 73) in the technical section of this catalogue.

VERTIKAL KLEMMHALTER I VERTICAL TOOLHOLDERS

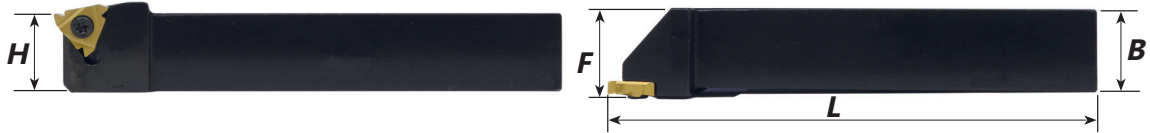

Artikelnummer (Item Number)	B = H	Länge (Length) L	F	Wende- plattengröße (Insert Size)	Torx Schlüssel (Torx Key)	Schraube Gewindeplatte (Insert Screw)
AR20-3V	20	125	22	16	TX16	S3S
AR25-3V	25	150	27	16	TX16	S3S

VERTIKAL HALTER I VERTICAL TOOLHOLDERS

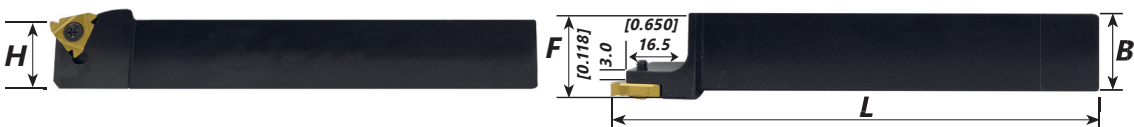

schmale Ausführung I slim Throat

Artikelnummer (Item Number)	B = H	Länge (Length) L	F	Wende- plattengröße (Insert Size)	Torx Schlüssel (Torx Key)	Schraube Gewindeplatte (Insert Screw)
AR16-3VS	16	100	18	16	TX16	S3S
AR20-3VS	20	125	22	16	TX16	S3S
AR25-3VS	25	150	27	16	TX16	S3S

INNENKLEMMHALTER / INTERNAL TOOLHOLDERS

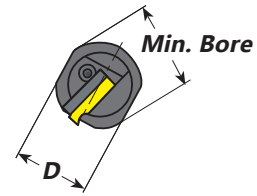
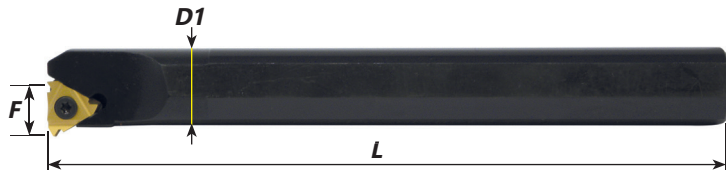

Artikelnummer (Item Number)	D	D1	Min. Bohr. Ø	L	L1	F	Wendepplattengröße (Insert Size)	Torx Schlüssel (Torx Key)	Schraube Gewindeplatte (Insert Screw)	Schraube Unterlegplatte (Anvil Screw)	RH Unterlegplatte (Anvil Screw)	LH Unterlegplatte (Anvil Screw)
IR05-0*	12	5.1	6.0	100	12	4.3	6	TX06	S0	-	-	-
IR07-1*	16	6.6	7.8	125	18	5.3	8	TX08	S1	-	-	-
IR08-1N*	16	7.3	9.0	125	21	6.6	8N	TX08	S1	-	-	-
IR10-2*	10	10	12	100	-	7.4	11	TX11	S2	-	-	-
IR10-2D*	16	10	12	125	25	7.4	11	TX11	S2	-	-	-
IR13-2*	16	13	15	140	32	8.9	11	TX11	S2	-	-	-
IR13-3*	16	13	16	150	32	10.2	16	TX16	S3S	-	-	-
IR16-3*	20	16	19	170	40	11.7	16	TX16	S3S	-	-	-
IR20-3	20	20	24	170	-	13.7	16	TX16	S3	A3	AI3	AE3
IR25-3	25	25	29	200	-	16.2	16	TX16	S3	A3	AI3	AE3
IR32-3	32	32	36	250	-	19.7	16	TX16	S3	A3	AI3	AE3
IR40-3	40	40	44	300	-	23.7	16	TX16	S3	A3	AI3	AE3
IR50-3	50	50	54	350	-	28.7	16	TX16	S3	A3	AI3	AE3
IR20-4*	20	20	24	170	-	15.6	22	TX22	S4S	-	-	-
IR25-4	25	25	29	200	-	18.1	22	TX22	S4	A4	AI4	AE4
IR32-4	32	32	38	250	-	21.6	22	TX22	S4	A4	AI4	AE4
IR40-4	40	40	46	300	-	25.6	22	TX22	S4	A4	AI4	AE4
IR50-4	50	50	56	350	-	30.6	22	TX22	S4	A4	AI4	AE4
IR32-4N	32	32	38	250	-	24.4	22N	TX22	S4	A4	AI4N	AE4N
IR40-4N	40	40	46	300	-	28.1	22N	TX22	S4	A4	AI4N	AE4N
IR50-4N	40	40	57	350	-	30.8	22N	TX22	S4	A4	AI4N	AE4N
IR32-5	32	32	40	250	-	22.6	27	TX27	S5	A5	AI5	AE5
IR40-5	40	40	48	300	-	26.6	27	TX27	S5	A5	AI5	AE5
IR50-5	50	50	58	350	-	31.6	27	TX27	S5	A5	AI5	AE5
IR60-5	60	60	68	400	-	36.6	27	TX27	S5	A5	AI5	AE5
IR32-5N	32	32	40	250	-	25.8	27N	TX27	S5	A5	AI5N	AE5N
IR40-5N	40	40	48	300	-	29.4	27N	TX27	S5	A5	AI5N	AE5N
IR50-5N	50	50	58	350	-	34.4	27N	TX27	S5	A5	AI5N	AE5N
IR60-5N	60	60	68	400	-	39.7	27N	TX27	S5	A5	AI5N	AE5N

*Klemmhalter ohne Unterlegplatte | Toolholders without anvil

Für **Linke Ausführung** schreiben Sie **IL** statt **IR** | For **Left Hand** toolholders specify **IL** instead of **IR**

Die Klemmhalter werden mit einem Steigungswinkel von 1.5° hergestellt. Um den Steigungswinkel zu ermitteln, verwenden Sie bitte die Diagramme im technischen Teil (Seite 73).
Toolholders are made with a 1.5° helix angle. For other helix angle please refer to helix angle chart (page 73) in the technical section of this catalogue.

INNENKLEMMHALTER | INTERNAL TOOLHOLDERS



mit Innenkühlung | with internal coolant

Artikelnummer (Item Number)	D	D1	Min. Bohr. Ø	L	L1	F	Wendepplattengröße (Insert Size)	Torx Schlüssel (Torx Key)	Schraube Gewindeplatte (Insert Screw)	Schraube Unterlegplatte (Anvil Screw)	RH Unterlegplatte (Anvil Screw)	LH Unterlegplatte (Anvil Screw)
IR10-3B*	16	10	12	125	25	7.4	11	TX11	S2	-	-	-
IR13-3B	16	13	16	150	32	10.2	16	TX16	S3S	-	-	-
IR16-3B	20	16	19	170	40	11.7	16	TX16	S3S	-	-	-
IR20-3B	20	20	24	170	-	13.7	16	TX16	S3	A3	AI3	AE3
IR25-3B	25	25	29	200	-	16.2	16	TX16	S3	A3	AI3	AE3
IR25-4B	25	25	29	200	-	18.1	22	TX22	S4	A4	AI4	AE4

*Klemmhalter ohne Unterlegplatte | Toolholders without anvil

Für **Linke Ausführung** schreiben Sie **IL** statt **IR** | For **Left Hand** toolholders specify **IL** instead of **IR**

Die Klemmhalter werden mit einem Steigungswinkel von 1.5° hergestellt. Um den Steigungswinkel zu ermitteln, verwenden Sie bitte die Diagramme im technischen Teil (Seite 73).
Toolholders are made with a 1.5° helix angle. For other helix angle please refer to helix angle chart (page 73) in the technical section of this catalogue.

VOLLHARTMETALL BOHRSTANGEN CARBIDE SHANK BORING BARS

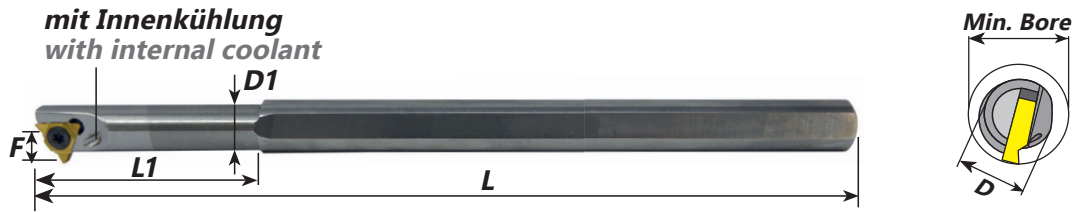

mit Innenkühlung | with internal coolant

Artikelnummer (Item Number)	D	D1	Min. Bohr. Ø	L	L1	F	Wendeplattengröße (Insert Size)	Torx Schlüssel (Torx Key)	Schraube Gewindeplatte (Insert Screw)	Schraube Unterlegplatte (Anvil Screw)	RH Unterlegplatte (Anvil Screw)	LH Unterlegplatte (Anvil Screw)
IR05-0SCO	6	5.1	6.0	100	26	4.3	6	TX06	S0	-	-	-
IR07-1CB	8	6.6	7.8	125	31	5.3	8	TX08	S1	-	-	-
IR08-1NCO	8	7.3	90	125	35	6.6	8N	TX08	S1	-	-	-
IR10-2CB	10	10	12	150	-	7.4	11	TX11	S2	-	-	-
IR12-2CB	12	12	15	170	-	8.4	11	TX11	S2	-	-	-
IR16-3CB	16	16	19	200	-	11.7	16	TX16	S3S	-	-	-
IR20-3CB	20	20	24	250	-	13.7	16	TX16	S3	A3	AI3	AE3
IR25-3CB	25	25	29	250	-	16.2	16	TX16	S3	A3	AI3	AE3
IR20-4SCO	20	20	24.5	250	-	15.6	22	TX22	S4	-	-	-

Für **Linke Ausführung** schreiben Sie **IL** statt **IR** | For **Left Hand** toolholders specify **IL** instead of **IR**

BOHRSTANGEN | BORING BARS

mit 3.5° Steigungswinkel | with 3.5° Helix Angle

Artikelnummer (Item Number)	D	D1	Min. Bohr. Ø	L	L1	F	Wendeplattengröße (Insert Size)	Torx Schlüssel (Torx Key)	Schraube Gewindeplatte (Insert Screw)
IR16-3CO35	20	16	19	170	40	13.7	16	TX16	S3S
IR20-4CO35	20	20	24	170	-	15.6	22	TX22	S4S

Für **Linke Ausführung** schreiben Sie **IL** statt **IR** | For **Left Hand** toolholders specify **IL** instead of **IR**

***HALTER FÜR SPEZIELLE GEWINDEDREHANWENDUNG
SPECIAL THREAD TURNING APPLICATIONS***

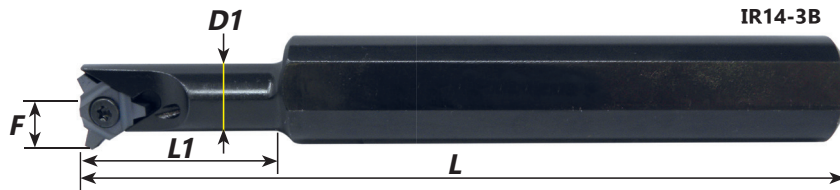

Artikelnummer (Item Number)	D	D1	L	L1	F	Wende- plattengröße (Insert Size)	Torx Schlüssel (Torx Key)	Schraube Gewindeplatte (Insert Screw)	Gewinde (Thread)
IR09-08*	16	8.7	125	30	6.5	8	S1	TX8	1/2 - 13UNC
IR12-3B	20	11.5	140	33	10.5	16	S3	TX16	TR18x4
IR14-3B	20	12.5	140	36	21.1	16	S3	TX16	TR20x4
IR14-3NCO	20	13.5	150	40	13.2	16	S3	TX16	TR22x5
IR25-4NCO	25	-	250	-	19.5	22	S4	TX22	TR40x7

Für linke Ausführung bitte anfragen | For left version please inquire

*Nur als rechte Ausführung verfügbar | Only right hand available

GEWINDE-STEIGUNGSWINKEL (THREAD HELIX ANGLE)

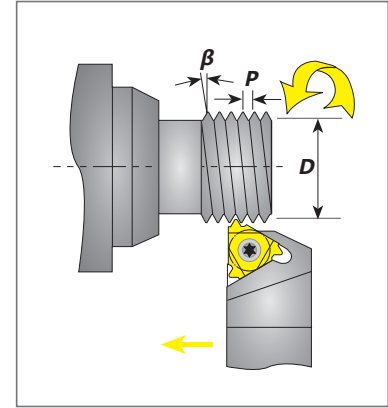
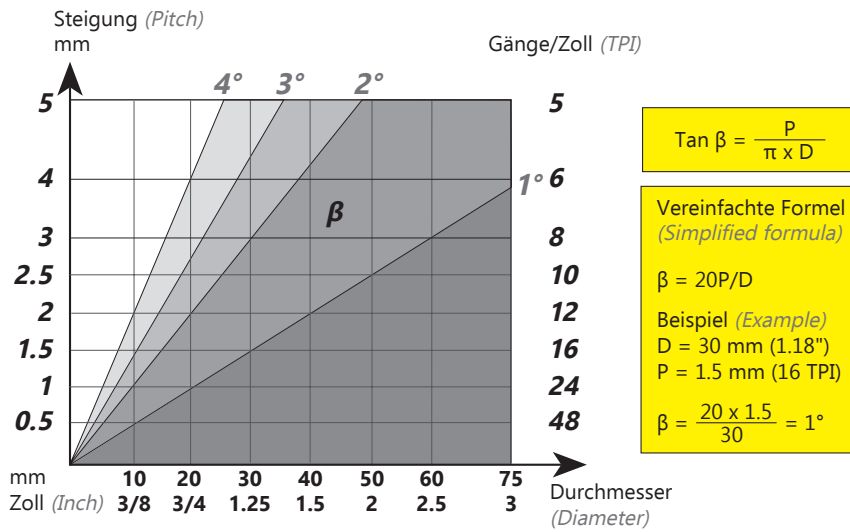

REGULÄRE UND KORRIGIERTE UNTERLEGPLATTEN (STANDARD AND SLANTED ANVILS)

Die Halter haben einen eingebauten Steigungswinkel von 1.5°. Dieser Winkel kann zur besseren Anpassung an den Steigungswinkel verstellt werden, indem die Unterlegplatte einfach ausgewechselt wird. Ein negativer Steigungswinkel wird gewöhnlich beim Drehen von Rechtsgewinden mit linkem Klemmhalter oder von Linksgewinden mit rechtem Klemmhalter benutzt.

(Toolholder Pockets have a built in 1.5° helix angle. This angle may be adjusted to better match the thread helix angle by simply changing the anvil. Negative helix angle is usually used when threading RH thread with LH Holder or LH thread with RH holder.)

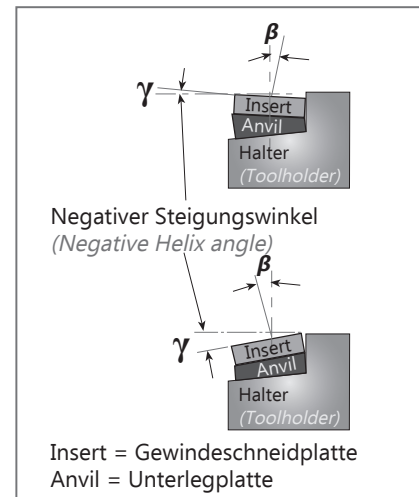

L	IC	Steigungswinkel Klemmhalter γ (Pocket Angle)	4.5°	3.5°	2.5°	1.5° Standard	0.5°	-0.5°	-1.5°
16	3/8	EX-RH OR IN-LH	AE3+4.5	AE3+3.5	AE3+2.5	AE3	AE3+0.5	AE3-0.5	AE3-1.5
16	3/8	EX-LH OR IN-RH	AI3+4.5	AI3+3.5	AI3+2.5	AI3	AI3+0.5	AI3-0.5	AI3-1.5
22	1/2	EX-RH OR IN-LH	AE4+4.5	AE4+3.5	AE4+2.5	AE4	AE4+0.5	AE4-0.5	AE4-1.5
22	1/2	EX-LH OR IN-RH	AI4+4.5	AI4+3.5	AI4+2.5	AI4	AI4+0.5	AI4-0.5	AI4-1.5
22N	1/2N	EX-RH OR IN-LH	AE4N+4.5	AE4N+3.5	AE4N+2.5	AE4N	AE4N+0.5	AE4N-0.5	AE4N-1.5
22N	1/2N	EX-LH OR IN-RH	AI4N+4.5	AI4N+3.5	AI4N+2.5	AI4N	AI4N+0.5	AI4N-0.5	AI4N-1.5
27	5/8	EX-RH OR IN-LH	AE5+4.5	AE5+3.5	AE5+2.5	AE5	AE5+0.5	AE5-0.5	AE5-1.5
27	5/8	EX-LH OR IN-RH	AI5+4.5	AI5+3.5	AI5+2.5	AI5	AI5+0.5	AI5-0.5	AI5-1.5
27N	5/8N	EX-RH OR IN-LH	AE5N+4.5	AE5N+3.5	AE5N+2.5	AE5N	AE5N+0.5	AE5N-0.5	AE5N-1.5
27N	5/8N	EX-LH OR IN-RH	AI5N+4.5	AI5N+3.5	AI5N+2.5	AI5N	AI5N+0.5	AI5N-0.5	AI5N-1.5

3

GEWINDEDREHEN TECHNISCHER TEIL

THREAD TURNING TECHNICAL SECTION

HARTMETALLSORTEN (CARBIDE GRADES)

Beschichtete Qualitäten (Coated Grades):

TiAlN (P20-P40, K20-K30):

PVD TiAlN beschichtete Ultra-Feinstkornqualität für Stahl, rostfreien Stahl und exotische Materialien bei mittleren bis hohen Schnittgeschwindigkeiten.

PVD TiAlN coated sub-micrograin grade for steel, stainless steels and exotic materials at medium to high cutting speeds.

XTiAlN (M10-M20, K05-K20, N10-N20, S10-S20):

PVD Dreilagenschicht Feinstkorn-Hartmetall für Edelstahl, Gusseisen, Titan, NE-Metall und die meisten Hochtemperaturlegierungen.

PVD triple layer coated sub-micron grade for stainless steels, cast iron, titanium, non-ferrous metals and most of the high temperature alloys.

TiN (K10-K20, P10-P25):

PVD TiN beschichtete Feinkornqualität für Automatenstähle, legierte Stähle (unter 30 HRC), für rostfreien Stahl und Gusseisen.

PVD TiN coated micrograin grade for free machining steels, alloy steels (below 30 HRC), stainless steels and cast iron.

Unbeschichtete Qualitäten (Uncoated Grades):

K20 (K10-K30), auf Anfrage | upon Request:

Verfügbare Plattengrößen und Beschichtungen (Available grades and coatings):

Beschichtung Grade	TiAlN	XTiAlN	TiN
Plattengröße (Insert sizes)	0, 1, 2, 3, 4, 5	2, 3, 4	2, 3, 4, 5

SCHNITTGESCHWINDIGKEIT EMPFEHLUNG (M/MIN)
(RECOMMENDED CUTTING SPEED)

ISO Standard	Material		Beschaffenheit Condition	XTiAIN	TiAIN	TiN
P	Unlegierter Stahl und Stahlguss, Automatenstahl <i>Non-Alloy Steel and Cast Steel, Free Cutting Steel</i>	<0.25%C	Gehärtet <i>Annealed</i>	110-210	120-180	100-180
		≥0.25%C	Gehärtet <i>Annealed</i>			
		<0.55%C	Geglüht und gepresst <i>Quenched & Tempered</i>			
		≥0.55%C	Gehärtet <i>Annealed</i>			
	Niedrig legierter Stahl und Stahlguss (weniger als 5% legierte Stoffe) <i>Low Alloy Steel and Cast Steel (less than 5% alloying elements)</i>		Gehärtet <i>Annealed</i>	90-140	80-130	70-120
			Geglüht und gepresst <i>Quenched & Tempered</i>			
Hochlegierter Stahl, Stahlguss und Werkzeugstahl <i>High Alloy Steel, Cast Steel and Tool Steel</i>		Gehärtet <i>Annealed</i>	70-90	60-80	55-70	
		Geglüht und gepresst <i>Quenched & Tempered</i>				
M	Edelstahl und Edelstahlguss <i>Stainless Steel and Cast Steel</i>		Ferritisch / Martensitisch <i>Ferritic / Martensitic</i>	110-160	90-130	60-90
			Martensitisch <i>Martensitic</i>			
			Austinitisch <i>Austenitic</i>			
K	Kugelgraphitgusseisen (GGG) <i>Nodular Cast Iron (GGG)</i>		Ferritisch / Perlitisch <i>Ferritic / Pearlitic</i>	120-150	100-130	80-110
			Perlitisch <i>Pearlitic</i>			
	Grauguss (GG) <i>Grey Cast Iron (GG)</i>		Ferritisch <i>Ferritic</i>	140-150	120-130	90-100
			Perlitisch <i>Pearlitic</i>			
	Temperguss <i>Malleable Cast Iron</i>		Ferritisch <i>Ferritic</i>	110-140	100-130	80-100
		Perlitisch <i>Pearlitic</i>				
N	Aluminiumknetlegierung <i>Aluminum-Wrought Alloy</i>		Ungealtert <i>Not Hardened</i>	700-1000		600-800
			Gealtert <i>Precipitation Hardened</i>			
	Aluminiumguss, vergütet <i>Aluminum-Cast, Alloyed</i>	<=12% Si	Ungealtert <i>Not Hardened</i>	280-750		200-550
		>12% Si	Hochwarmfest <i>High</i>			
	Kupferlegierung <i>Copper Alloys</i>	>1% Pb	Automatenkupferlegierung <i>Free Cutting</i>	190-350		150-250
			Messing <i>Brass</i>			
			Elektrolytkupfer <i>Electrolytic Copper</i>			
	Nichtmetallische Werkstoffe <i>Copper Alloys</i>		Thermoplast, Faserverbundwerkstoff <i>Duroplastics, Fiber Plastics</i>			200-300
Hartgummi <i>Hard Rubber</i>						
S	Hochtemperaturlegierungen, Superlegierung <i>High Temp. Alloys, Super Alloys</i>	Fe based	Gehärtet <i>Annealed</i>	30-65	25-60	
			Gealtert <i>Precipitation Hardened</i>			
		Ni or Co based	Gehärtet <i>Annealed</i>			
			Gealtert <i>Precipitation Hardened</i>			
			Guss Cast			
Titanlegierung <i>Titanium Alloys</i>		Alpha+Beta Legierung gealtert <i>Alpha + Beta Alloys Cured</i>	40-50		35-45	
H	Gehärteter Stahl <i>Hardened Steel</i>		Gehärtet <i>Hardened</i> 45-50 HRC	40-50	35-45	
			Gehärtet <i>Hardened</i> 51-55 HRC			
			Gehärtet <i>Hardened</i> 56-62 HRC			
	Schalenhartguss <i>Chilled Cast Iron</i>		Guss Cast	30-40		25-35
Gusseisen <i>Cast Iron</i>		Gehärtet <i>Hardened</i>	20-30		15-25	

UMRECHNUNG VON SCHNITTGESCHWINDIGKEIT IN DREHGESCHWINDIGKEIT (CONVERSION OF CUTTING SPEED TO ROTATIONAL SPEED)

Die Umrechnung der gewählten Schnittgeschwindigkeit in Drehgeschwindigkeit erfolgt nach folgender Formel:
(Conversion of a selected cutting speed to rotational speed is calculated using the following formula):

Beispiel (Example):

$$N = \frac{V \times 1000}{\pi \times D} = \frac{120 \times 1000}{\pi \times 30} = 1274 \text{ UPM/RPM}$$

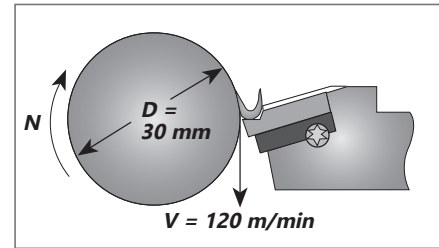

ZUSTELLUNGSWERTE FÜR MEHRZAHNPLATTEN (NUMBER OF PASSES AND DEPTH OF CUT PER PASS FOR MULTI-TOOTH INSERT)

	Steigung mm	Plattengröße		Anzahl der Zähne	Bestellcode	Anzahl Durchgänge	Schnitttiefe pro Durchgang			
		L	I.C. (Zoll)				1	2	3	4
ISO Außen	1.00	16	3/8	3	3ER1.0ISO3M	2	0.38	0.25		
	1.50	16	3/8	2	3ER1.5ISO2M	3	0.42	0.30	0.20	
	1.50	22	1/2	3	4ER1.5ISO3M	2	0.55	0.37		
	2.00	22	1/2	2	4ER2.0ISO2M	3	0.57	0.40	0.28	
	2.00	22	1/2	3	4ER2.0ISO3M	2	0.76	0.49		
	3.00	27	5/8	2	5ER3.0ISO2M	4	0.59	0.51	0.42	0.32
ISO Innen	1.00	16	3/8	3	3IR1.0ISO3M	2	0.33	0.25		
	1.50	16	3/8	2	3IR1.5ISO2M	3	0.38	0.29	0.20	
	1.50	22	1/2	3	4IR1.5ISO3M	2	0.50	0.37		
	2.00	22	1/2	2	4IR2.0ISO2M	3	0.52	0.37	0.26	
	2.00	22	1/2	3	4IR2.0ISO3M	2	0.70	0.45		
	3.00	27	5/8	2	5IR3.0ISO2M	4	0.58	0.46	0.39	0.30
UN Außen	16	16	3/8	2	3ER16UN2M	3	0.44	0.31	0.22	
	16	22	1/2	3	4ER16UN3M	2	0.58	0.39		
	12	22	1/2	2	4ER12UN2M	3	0.59	0.42	0.30	
	12	22	1/2	3	4ER12UN3M	2	0.78	0.52		
	8	27	5/8	2	5ER8UN2M	4	0.62	0.54	0.45	0.35
UN Innen	16	16	3/8	2	3IR16UN2M	3	0.42	0.28	0.22	
	16	22	1/2	3	4IR16UN3M	2	0.55	0.37		
	12	22	1/2	2	4IR12UN2M	3	0.53	0.38	0.31	
	12	22	1/2	3	4IR12UN3M	2	0.74	0.48		
	8	27	5/8	2	5IR8UN2M	4	0.63	0.50	0.40	0.30
Whitworth 55° Außen	14	16	3/8	2	3ER14W2M	3	0.52	0.37	0.27	
	14	22	1/2	3	4ER14W3M	2	0.70	0.46		
	11	22	1/2	2	4ER11W2M	3	0.67	0.47	0.34	
Whitworth 55° Innen	14	16	3/8	2	3IR14W2M	3	0.52	0.37	0.27	
	14	22	1/2	3	4IR14W3M	2	0.70	0.46		
	11	22	1/2	2	4IR11W2M	2	0.67	0.47	0.34	
	14	16	3/8	2	3ER14NPT2M	3				
NPT Außen	11.5	22	1/2	2	4ER11.5NPT2M	4	0.54	0.47	0.37	0.30
	11.5	27	5/8	3	5ER11.5NPT3M	4	0.76	0.54	0.38	
	8	27	5/8	2	5ER8NPT2M	4	0.81	0.60	0.55	0.45
NPT Innen	14	16	3/8	2	3IR14NPT2M	3				
	11.5	22	1/2	2	4IR11.5NPT2M	4	0.54	0.47	0.37	0.30
	11.5	27	5/8	3	5IR11.5NPT3M	4	0.76	0.54	0.38	
	8	27	5/8	2	5IR8NPT2M	4	0.81	0.60	0.55	0.45
API Rund Außen	10	22	1/2	2	4ER10APIRD2M	3	0.60	0.50	0.31	
	10	27	5/8	3	5ER10APIRD3M	2	1.00	0.41		
	8	27	5/8	2	5ER8APIRD2M	3	0.80	0.60	0.41	
API Rund Innen	10	22	1/2	2	4IR10APIRD2M	3	0.60	0.50	0.31	
	10	27	5/8	3	5IR10APIRD3M	2	1.00	0.41		
	8	27	5/8	2	5IR8APIRD2M	3	0.80	0.60	0.41	

EMPFOHLENE ANZAHL DER DURCHGÄNGE BEIM GEWINDESCHNEIDEN (RECOMMENDED NUMBER OF PASSES FOR THREADING INSERTS):

Steigung (Pitch): mm Gänge/Zoll (TPI)	0.5 48	0.8 32	1.0 24	1.25 20	1.5 16	1.75 14	2.0 12	2.5 10	3.0 8	4.0 6	6.0 4
Anzahl der Durchgänge (Number of Passes)	3-6	4-7	4-9	6-10	5-11	9-12	6-13	7-15	8-17	10-20	11-22

Hinweise (Recommendations):

- In den meisten Fällen ist der Mittelwert ein guter Startpunkt.
- Bei den meisten Materialien gilt, je härter das Material, umso höher die Anzahl der gewählten Durchgänge.
- Als Faustregel gilt: weniger Durchgänge sind besser als eine höhere Geschwindigkeit.
- For most standard applications, the middle of the range is a good starting point.
- For most materials, the tougher the material, the higher the number of cutting passes you should select.
- As a general rule of thumb, fewer passes are better than higher speed.

GEWINDESCHNEID METHODEN (THREAD TURNING METHODS):

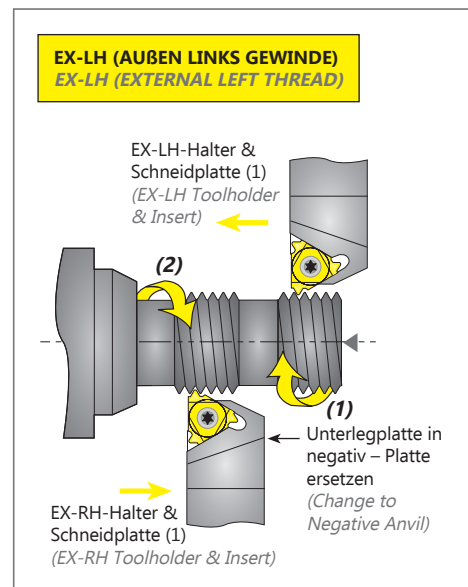
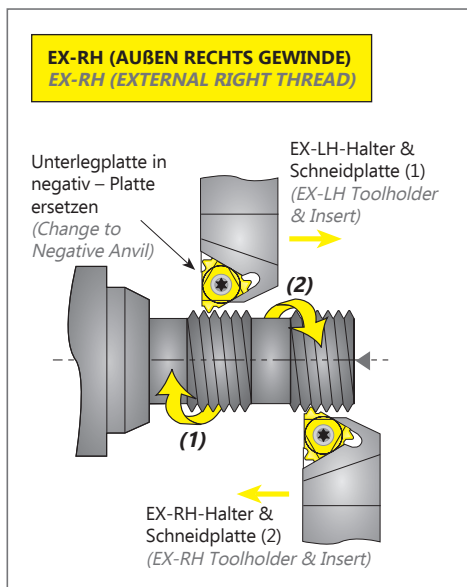

Um ein EX-LH-Gewinde zu drehen wenn man nur EX-RH-Schneidplatte & Halter hat.
(If you want to turn an EX-LH Thread and you only have EX-Rh Insert & Toolholder)

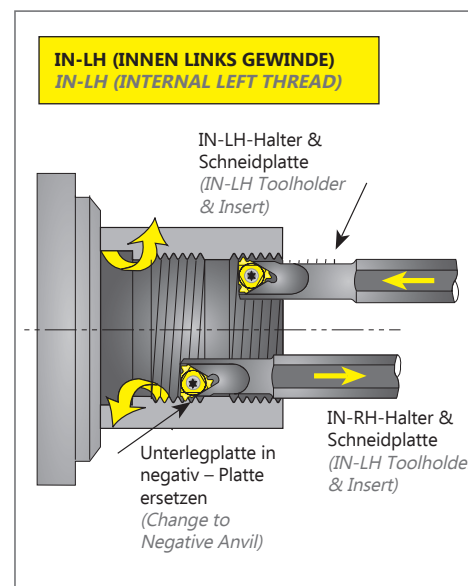
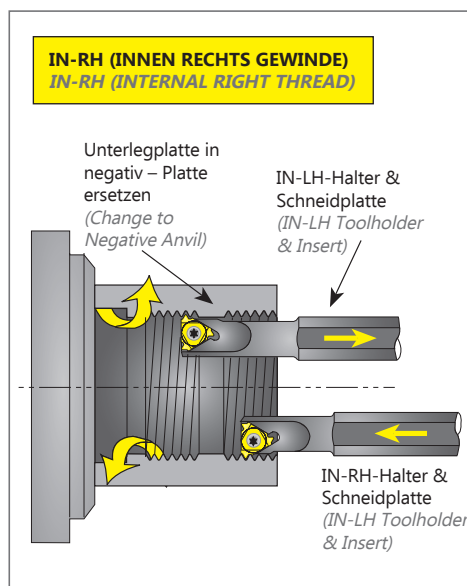

Sie sollten eine IN-LH-Schneidplatte und einen Halter benutzen, wenn Sie ein IN-RH-Gewinde drehen wollen, so werden die Metallspäne beim Drehen nach außen gezogen.
(You should use an IN-LH Insert and Toolholder, if you want to turn an IN-RH Thread but it is recommended to evacuate metal chips outside during thread turning.)

HINWEISE ZU GEWINDEDREHPLATTEN (RECOMMENDATIONS FOR THREADING INSERTS)

Bei den meisten Gewindeformen haben die Außen- und Innengewinde verschiedene Tiefen und Radien. Sie sind also nicht austauschbar.
(In most thread forms internal and external threads have different depth and radii, thus tools are not interchangeable)

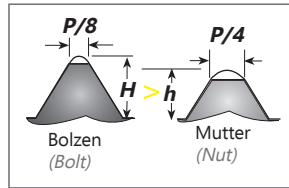

Der Neigungswinkel eines Standard Außenhalters ist 10° und 15° für Innenhalter. Der Innenhalter-Neigungswinkel ist größer als der Außenhalter-Neigungswinkel, um zusätzlich erforderlichen radialen Spielraum zu gewähren.
(The Insert relief angle of a standard external toolholder is 10°; for an internal toolholder it is 15°. This 5° difference is to provide additional necessary radial clearance.)

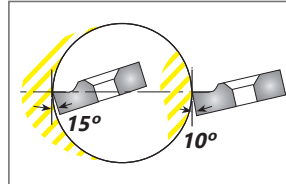

Der eingebaute (built-in) Neigungswinkel garantiert dem Freiwinkel automatisch Spielraum.
(The built-in relief angles ensure automatic insert flank angle clearance.)

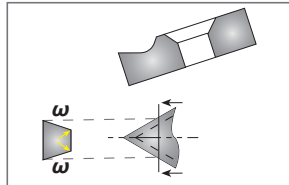

Die Profile der Außen- und Innengewindeschneidplatten sind präzise geschliffen und garantieren genaue Gewindegeometrie, wenn sie mit den passenden Haltern benutzt werden. Innen-Gewindeschneidplatten in Außenhaltern beeinflussen Schneidplattengeometrie und Winkel nachteilig.
(Profiles of internal & external threading inserts are precision ground to ensure accurate thread geometry when used on the matching toolholders. Using internal inserts with an external holder will result in distortion of angle and insert geometry.)

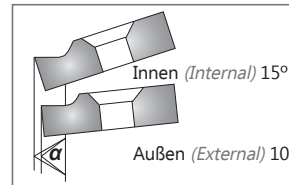

Gewindeschneidplatte und Halter sollten immer zusammenpassen. Eine IN-RH-Schneidplatte muss zusammen mit einem IN-RH-Halter eingesetzt werden. Andere Kombinationen sind nicht möglich.
(Insert and toolholder should always match. An IN-RH insert must be used with an IN-RH toolholder. No mismatch is allowed.)



FLANKENFREIWINKEL (FLANK CLEARANCE ANGLE) ω

$$\omega = \text{ArcTan}(\text{Tan } \alpha \times \text{Tan } \Phi)$$

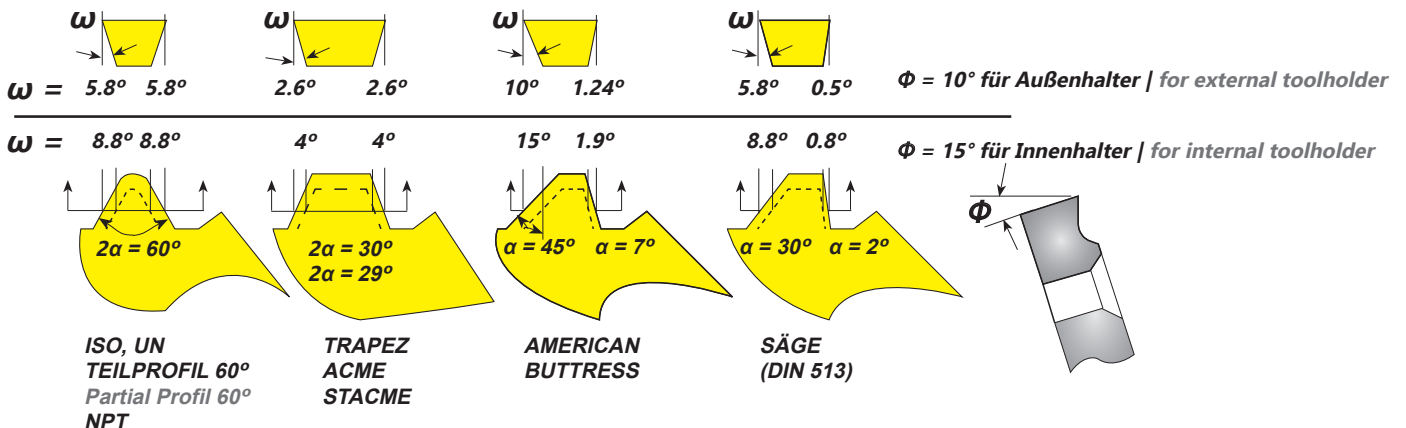

STIEGUNGSWINKELDIAGRAMM ZUM AUSTAUSCH DER UNTERLEGPLATTEN (HELIX ANGLE DIAGRAM FOR ANVIL SELECTION)

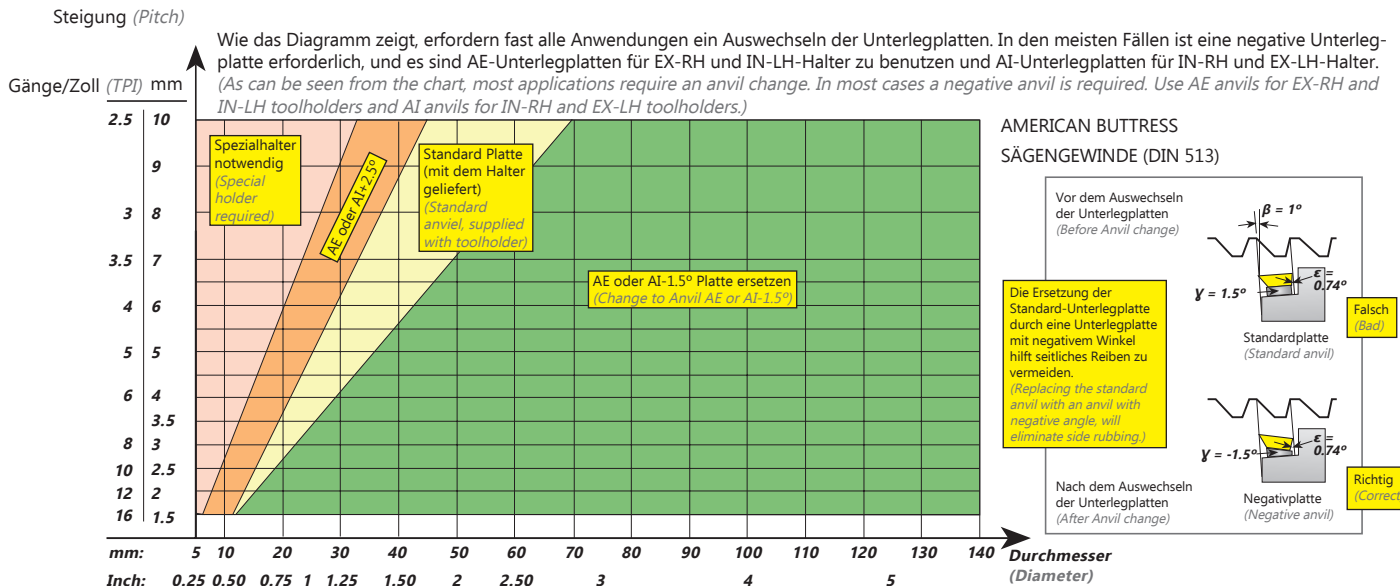
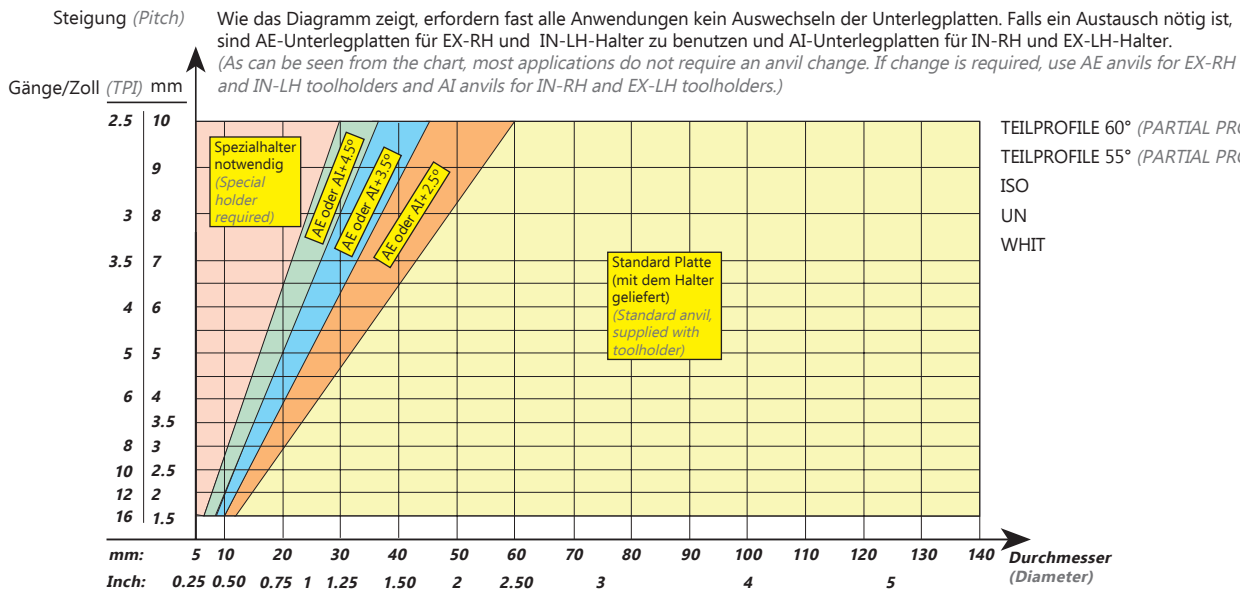
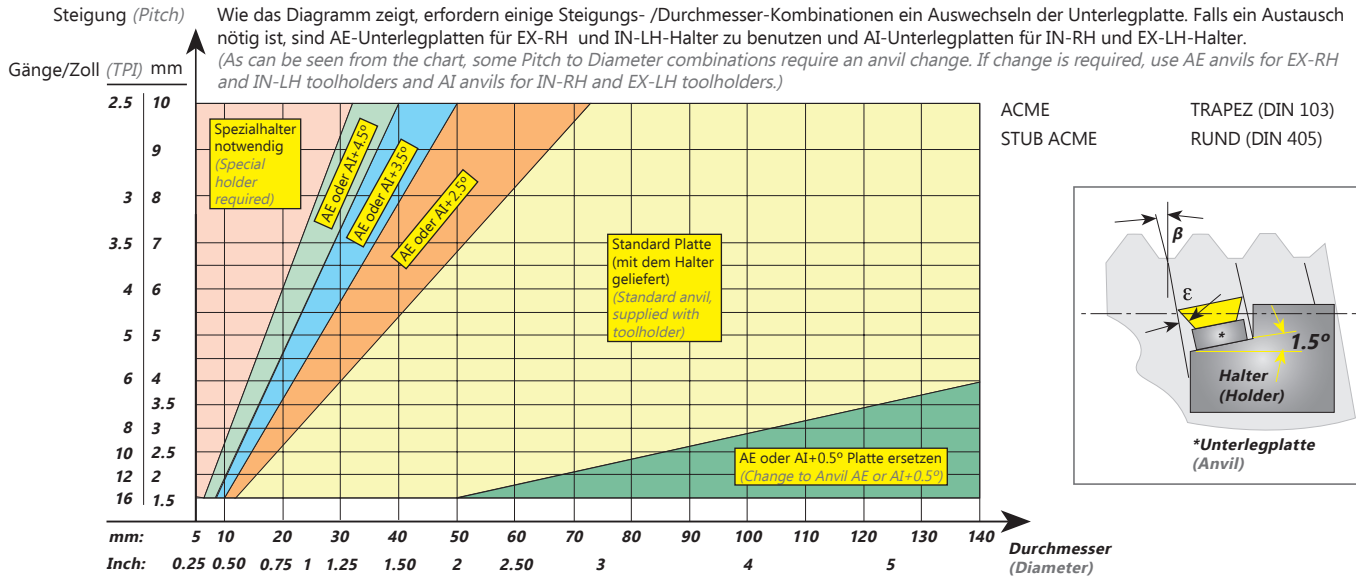

GEWINDESCHNEIDEN (THREAD TURNING)

- Schritt 1: Gewindegewindeschneidsystem wählen
 Schritt 2: Gewindegewindeschneidplatte wählen
 Schritt 3: Halter wählen
 Schritt 4: Qualität der Gewindegewindeschneidplatte wählen
 Schritt 5: Gewindegewindeschneid-Drehgeschwindigkeit wählen
 Schritt 6: Schnittanzahl wählen Tiefen und Radien

- Step 1 : Choose Thread Turning Method
 Step 2 : Choose Insert
 Step 3 : Choose Toolholder
 Step 4 : Choose Insert Grade
 Step 5 : Choose Thread Turning Speed
 Step 6 : Choose Number of Threading Passes

Meistens reichen beim Gewindegewindeschneiden die ersten 6 Schritte, um ein gutes Gewinde zu erzielen. Bei den asymmetrischen Gewinden BUTTRESS und SÄGE muss eine Unterlegplatte mit negativem Steigungswinkel verwendet werden.
 (In most cases the above mentioned 6 steps would be the steps needed to ensure a good thread. For asymmetric threads Buttress and Sage, an anvil with a negative pitch angle must be used.)

- Schritt 7: den Gewindesteigungswinkel berechnen
 Schritt 8: die richtige Unterlegplatte wählen

- Step 7 : Find Thread Helix Angle
 Step 8 : Choose Correct Anvil

BEISPIELE (EXAMPLES):

BEISPIEL NR. 1 (EXAMPLE NO. 1):

Schritt 1: Gewindegewindeschneidsystem auf Seite 79 wählen: EX-RH- Gewindegewindeschneidplatte und Halter.
 Step 1:

Choose Thread Turning Method from page 79: EX-RH Insert & Toolholder.

Schritt 2: Gewindegewindeschneidplatte auf Seite 17 wählen: 3ER1.5ISO.
 Step 2:

Choose Insert from page 17: 3ER1.5ISO.

Schritt 3: Halter auf Seite 67 wählen: AR20-3.
 Step 3:

Choose Toolholder from page 67: AR20-3.

Schritt 4: Gewindegewindeschneidplatten-Qualität auf Seite 76 auswählen: legierten Stahl, TIN-Qualität.
 Step 4:

Choose Insert Grade from selection on page 76: Alloy Steel is Grade TIN.

Schritt 5: Gewindegewindeschneid-Drehgeschwindigkeit aus der Tabelle auf Seite 77 wählen: 100 m/min.
 Step 5:

Choose Thread Turning Speed from chart on page 77: 100 m/min.

Drehgeschwindigkeitsberechnung:

Rotational Speed calculation:

$$N = \frac{100 \times 1000}{\pi \times 30} = 1065 \text{ UPM RPM}$$

Schritt 6: Schnittanzahl aus der Tabelle auf Seite 79 wählen: 8 Gänge.
 Step 6:

Choose Number of Threading passes from table on page 79: 8 passes.

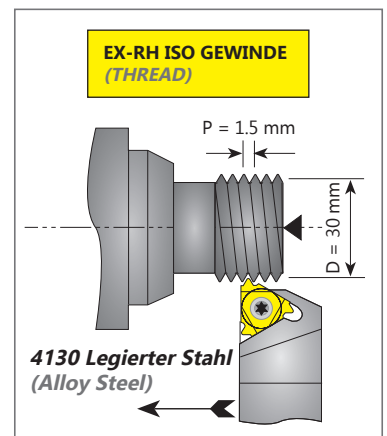

BEISPIELE (EXAMPLES):

BEISPIEL NR. 2 (EXAMPLE NO. 2):

Schritt 1: Gewindegewindeschneidsystem auf Seite 79 wählen, normalerweise nimmt man IN-RH-Halter und Gewindegewindeschneidplatte. Die Späne sollen aber nach außen geführt werden, indem wir vom Bund nach außen arbeiten. Wir benötigen dafür: Gewindegewindeschneidplatte und Halter.
 Step 1:

Choose Thread Turning Method from page 79. Usually, an IN-RH Toolholder and Insert will be chosen, however, in this particular case we prefer to pull the metal chips while thread turning outward, thus we chose to work with IN-LH Insert & Toolholder

Schritt 2: Gewindegewindeschneidplatte auf Seite 28 wählen: 3IL12UN.
 Step 2:

Choose Insert from page 28: 3IL12UN.

Schritt 3: Halter auf Seite 69 wählen: IL25-3.
Step 3: Anmerkung: da wir IN-RH Gewinde mit IN-LH-Werkzeug nach außen geschnitten haben, nicht vergessen, die Standard-Unterlegplatte (die mit dem Halter geliefert wird) durch eine negativ Unterlegplatte zu ersetzen: AE3-1.5.

Choose Toolholder from page 69: IL25-3. Note: since we thread cut IN-RH thread outward with an IN-LH tool, do not forget to replace the standard anvil (supplied with the holder) with a negative anvil AE3-1.5

Schritt 4: Gewindeschneidplatten-Qualität auf Seite 76 auswählen:
Step 4: Messing, Uncoated-Qualität.

Choose Insert Grade from selection on page 76:
Brass is Grade Uncoated.

Schritt 5: Gewindeschneid-Drehgeschwindigkeit auf Seite 77 wählen:
Step 5: wir nahmen 150 m/min.

Choose Thread Turning Speed from chart on page 77:
choose 150 m/min.

Drehgeschwindigkeitsberechnung:

Rotational Speed calculation:

$$N = \frac{150 \times 1000}{\pi \times 38.1} = 1254 \text{ UPM RPM}$$

Schritt 6: Schnittanzahl aus der Tabelle auf Seite 79 wählen: 9 Gänge.

Choose Number of Threading passes from table on page 79: 9 passes.

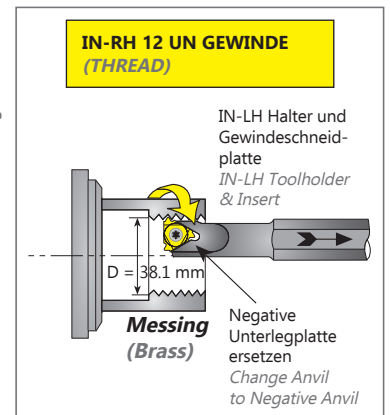

BEISPIEL NR. 3 (EXAMPLE NO. 3):

Schritt 1: Gewindeschneidsystem auf Seite 79 wählen:
Step 1: EX-RH-Gewindeschneidplatte und Halter.

Choose Thread Turning Method from page 79: EX-RH Insert & Toolholder.

Schritt 2: Gewindeschneidplatte auf Seite 59 wählen:
Step 2: 3ER12ABUT.

Choose Insert from page 59: 3ER12ABUT

Schritt 3: Halter auf Seite 67 wählen:
Step 3: AR25-3.

Choose Toolholder from page 67: AR25-3.

Schritt 4: Gewindeschneidplatten-Qualität auf Seite 76 auswählen:
Step 4: rostfreien Stahl für TiAlN-Qualität.

Choose Insert Grade from selection on page 76:
Stainless Steel is Grade TiAlN.

Schritt 5: Gewindeschneid-Drehgeschwindigkeit auf Seite 77 wählen:
Step 5: 120 m/min.

Choose Thread Turning Speed from chart on page 77:
120 m/min.

Drehgeschwindigkeitsberechnung:

Rotational Speed calculation:

$$N = \frac{120 \times 1000}{\pi \times 40} = 954 \text{ UPM RPM}$$

Schritt 6: Schnittanzahl aus der Tabelle auf Seite 79 wählen: 13 Gänge.

Choose Number of Threading passes from table on page 79: 13 passes.

Schritt 7: Gewindesteigungswinkel berechnen:
Step 7: Seite 73, für eine Steigung von 12 Gänge/Zoll und Durchmesser 40 ist der Steigungswinkel, wie das Diagramm zeigt, 1°.

Find Thread Helix Angle: on page 73 for Pitch of 12 TPI and 40 Diameter Helix Angle as shown in the chart is 1°.

Schritt 8: Die genaue Unterlegplatte wählen: Wie das Diagramm auf Seite 81 zeigt, für AMERICAN BUTTRESS, für 12 Gänge/Zoll und Durchmesser 40, sollte eine negative Unterlegplatte AE3-1.5 die Standard-Unterlegplatte, die mit dem Halter geliefert wird, ersetzen.

Choose correct Anvil: As can be seen from the chart on page 81, for AMERICAN BUTTRESS Thread, for 12 TPI and 40 Diameter a negative anvil AE3-1.5 should replace the standard anvil supplied with the toolholder.

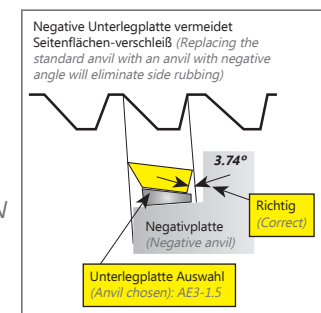
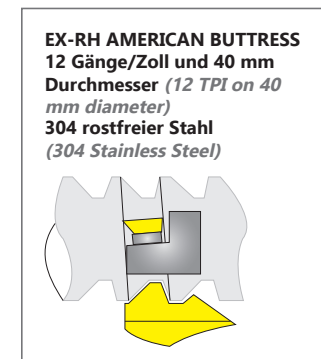

PROBLEMLÖSUNG (TROUBLESHOOTING)

Ausbröckelungen (Chipping):

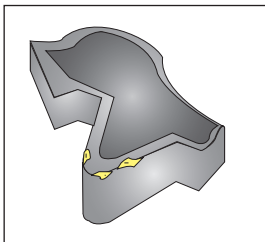

- | | |
|--|---|
| 1. Eine zähere Hartmetall-Qualität benutzen. | 1. Use a tougher carbide grade |
| 2. Überhang des Werkzeugs vermeiden. | 2. Eliminate tool overhang |
| 3. Prüfen, ob die Gewindeschneidplatte richtig festgeklemmt ist. | 3. Check if insert is correctly clamped |
| 4. Vibrationen vermeiden. | 4. Eliminate vibration |

Kolkverschleiß (Crater Wear):

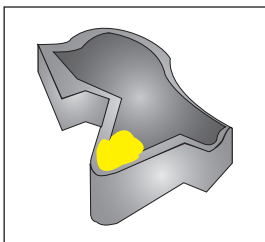

- | | |
|---|-------------------------------|
| 1. Schnittgeschwindigkeit herabsetzen. | 1. Reduce cutting speed |
| 2. Kühlflüssigkeit auftragen. | 2. Apply coolant fluid |
| 3. Eine härtere Hartmetall-Qualität benutzen. | 3. Use a harder carbide grade |

Aufbauschneide (Build-up Edge):

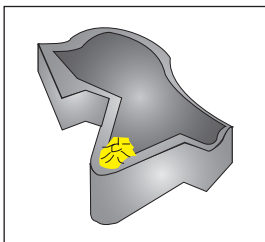

- | | |
|---|--------------------------------|
| 1. Schnittgeschwindigkeit erhöhen | 1. Increase cutting speed |
| 2. Eine zähere Hartmetall-Qualität benutzen | 2. Use a tougher carbide grade |

Wärmerisse (Thermal Cracking):

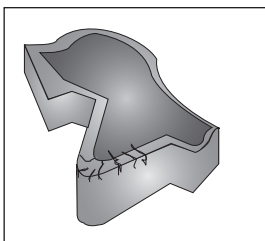

- | | |
|---|--------------------------------|
| 1. Schnittgeschwindigkeit herabsetzen | 1. Reduce cutting speed |
| 2. Kühlflüssigkeit auftragen | 2. Apply coolant fluid |
| 3. Eine zähere Hartmetall-Qualität benutzen | 3. Use a tougher carbide grade |

Verformung (Deformation):

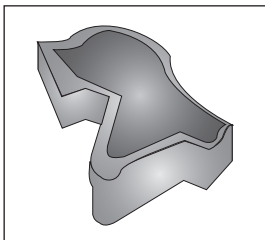

- | | |
|--|-------------------------------|
| 1. Eine härtere Hartmetall-Qualität benutzen | 1. Use a harder carbide grade |
| 2. Schnittgeschwindigkeit herabsetzen | 2. Reduce cutting speed |
| 3. Schnitttiefe reduzieren | 3. Reduce depth of cut |
| 4. Kühlflüssigkeit auftragen | 4. Apply coolant fluid |

Brechen (Fracture):

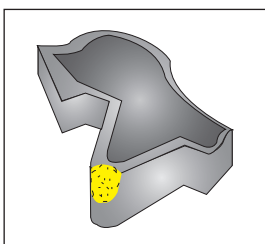

- | | |
|---|-------------------------------------|
| 1. Eine zähere Hartmetall-Qualität benutzen | 1. Use a tougher carbide grade |
| 2. Schnitttiefe reduzieren | 2. Reduce depth of cut |
| 3. Die Platte früher wechseln | 3. Index insert sooner |
| 4. Maschine und Werkzeugstabilität prüfen | 4. Check machine and tool stability |

GEWINDEPLATTEN STANDARDS
(THREADING INSERTS STANDARDS)

Gewindeprofil (Thread profile)	Standard	Gewindetoleranzklasse (Thread tolerance class)
ISO	DIN 13	6g / 6H
UN	ANSI B1.1-1989	2A / 2B
WHITWORTH	B.S. 84: 1956	Medium Class
NPT	ANSI B1.20.1-1983	-
NPTF	ANSI B1.20.3-1976	-
BSPT	B.S. 21: 1957	-
ACME	ANSI B1.5-1988	3G
STUB ACME	ANSI B1.5-1988	2G
TRAPEZ	DIN 103	7e / 7H
Rund	DIN 405	Class 7
UNJ	MIL-S-8879C	3A / 3B
MJ	ISO 5855	4h/6h 4H/5H
AMERICAN BUTTRESS	ANSI B1.9-1973	Class 2
SÄGENGEWINDE	DIN 513	-
PG	DIN 40430	-
V-0.040	API Spec7	-
V-0.038R	API Spec7	-
V-0.050	API Spec7	-
V-0.055	API Spec7	-
API Rund	API Spec Standard 5B	-
EXTREME – LINE CASING	API Spec Standard 5B	-
BUTTRESS CASING	API Spec Standard 5B	-

DIN: Deutsches Institut für Normung
 ANSI: American National Standards Institute
 API: American Petroleum Institute
 B.S.: British Standards
 ISO: Internationale Organisation für Normung
 MIL-S: Military Specification





4

STECHPLATTEN

GROOVING INSERTS

STECHPLATTEN / GROOVING INSERTS

Innen und Außen External and Internal

ER/IL
Die gleiche Platte kann für EX.RH und IN.LH. eingesetzt werden.
(Same insert can be used for EX.RH and for IN.LH.)

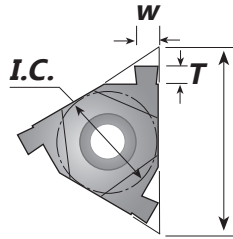
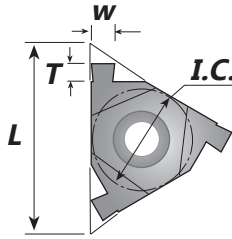

ER/IL
Die gleiche Platte kann für IN.RH und EX.LH. eingesetzt werden.
(Same insert can be used for IN.RH and for EX.LH.)



Artikelnummer (Item Number)	Unterlegplatte (Anvil)	w ± 0.02	I.C. Zoll (Inch)	L mm	T
3ER/IL0.50	AE3-0	0.50	3/8	16	1.4
3IR/EL0.50	AI3-0				
3ER/IL1.00	AE3-0	1.00	3/8	16	1.4
3IR/EL1.00	AI3-0				
3ER/IL1.20	AE3-0	1.20	3/8	16	1.6
3IR/EL1.20	AI3-0				
3ER/IL1.40	AE3-0	1.40	3/8	16	1.8
3IR/EL1.40	AI3-0				
3ER/IL1.70	AE3-0	1.70	3/8	16	2.0
3IR/EL1.70	AI3-0				
3ER/IL1.95	AE3-0	1.95	3/8	16	2.0
3IR/EL1.95	AI3-0				
3ER/IL2.25	AE3-0	2.25	3/8	16	2.25
3IR/EL2.25	AI3-0				

ER = Außen Rechts | External Right IR = Innen Rechts | Internal Right EL = Außen Links | External Left IL = Innen Links | Internal Left

Erhältlich in folgenden Qualitäten | Available in the following Grades: TiAIN

Die Platten sollten mit den Standard Haltern benutzt werden | The inserts should be used with the standard threading toolholders
Innenhalter mit Plattengröße 3 ohne Unterlegplatte können nicht benutzt werden | Size 3 internal holders without anvil can't be used

STECHPLATTEN | GROOVING INSERTS

Innen und Außen – Teilprofil External and Internal – Partial Profile

ER/IL
Die gleiche Platte kann für EX.RH und IN.LH. eingesetzt werden.
(Same insert can be used for EX.RH and for IN.LH.)

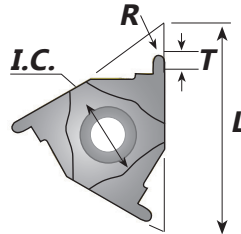
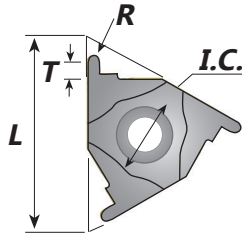

ER/IL
Die gleiche Platte kann für IN.RH und EX.LH. eingesetzt werden.
(Same insert can be used for IN.RH and for EX.LH.)



Radius für Innen- & Außenbearbeitung | Radius for internal & external machining

Artikelnummer (Item Number)	Unterlegplatte (Anvil)	R ± 0.02	I.C. Zoll (Inch)	L mm	T
3ER/ILR0.50	AE3-0	0.5	3/8	16	1.4
3IR/ELR0.50	AI3-0				
3ER/ILR1.00	AE3-0	1.0	3/8	16	2.0
3IR/ELR1.00	AI3-0				
3ER/ILR1.20	AE3-0	1.2	3/8	16	2.25
3IR/ELR1.20	AI3-0				

ER = Außen Rechts | *External Right* IR = Innen Rechts | *Internal Right* EL = Außen Links | *External Left* IL = Innen Links | *Internal Left*

Erhältlich in folgenden Qualitäten | *Available in the following Grades: TiAIN*

Die Platten sollten mit den Standard Haltern benutzt werden | *The inserts should be used with the standard threading toolholders*

Innenhalter mit Plattengröße 3 ohne Unterlegplatte können nicht benutzt werden | *Size 3 internal holders without anvil can't be used*

SCHNITTGESCHWINDIGKEIT FÜR STECHPLATTEN (CUTTING SPEEDS FOR GROOVING INSERTS)

Auswahl Hartmetallsorte (Carbide Grade):

TiAlN (P20-P40, K20-K30):

PVD TiAlN beschichtete Ultra-Feinstkornqualität für rostfreien Stahl und exotische Materialien bei mittleren bis hohen Schnittgeschwindigkeiten.

PVD TiAlN coated sub-micrograin grade for stainless steels and exotic materials at medium to high cutting speeds.

ISO Standard	Materialen (Materials)	Schnittgeschwindigkeit m/mni (Cutting speed)
P	Niedrig - & Mittel-Legierter Kohlenstoffstahl <i>Low & Medium Carbon Steel</i>	20 - 100
	Hoch-Legierter Kohlenstoffstahl <i>High Carbon Steel</i>	30 - 80
	Legierter Stahl <i>Alloy Steels and Treated Steels</i>	40 - 90
M	Rostfreier Stahl <i>Stainless Steels</i>	30 - 80
	Rostfreier Stahlguss <i>Cast Steels</i>	30 - 90
K	Gusseisen <i>Cast Iron</i>	30 - 90
N	NE-Metalle und Aluminium <i>Non-Ferrous and Aluminum</i>	20 - 200

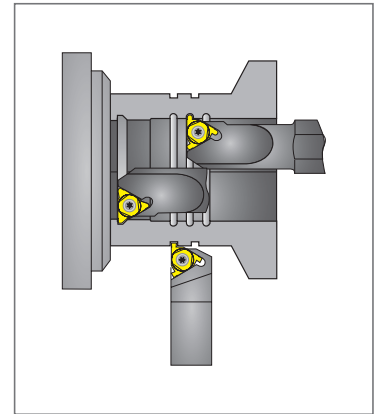

5

MINIATURWERKZEUGE

TINY TOOLS

VOLLHARTMETALLWERKZEUGE FÜR KLEINE BOHRUNGEN (SOLID CARBIDE TOOLS FOR WORKING IN SMALL BORES)

Schwarz Miniaturwerkzeuge sind speziell für die Hightech-Industrie, die Medizintechnik und die Kleinkomponenten Fertigung. Alle Ausdrehstäbe verfügen über einen Kühlmittelkanal entlang des Schaftes. Das Kühlmittel, das direkt auf die Schneide trifft, sorgt für einen weichen Schnitt und störende Späne werden beseitigt.

Schwarz Tiny tools are designed for the high-tech, medical and small component industry. All tools have coolant channels along the shafts enabling the cooling fluid to reach the cutting edge efficiently, for easy chip evacuation and smooth cutting operations.

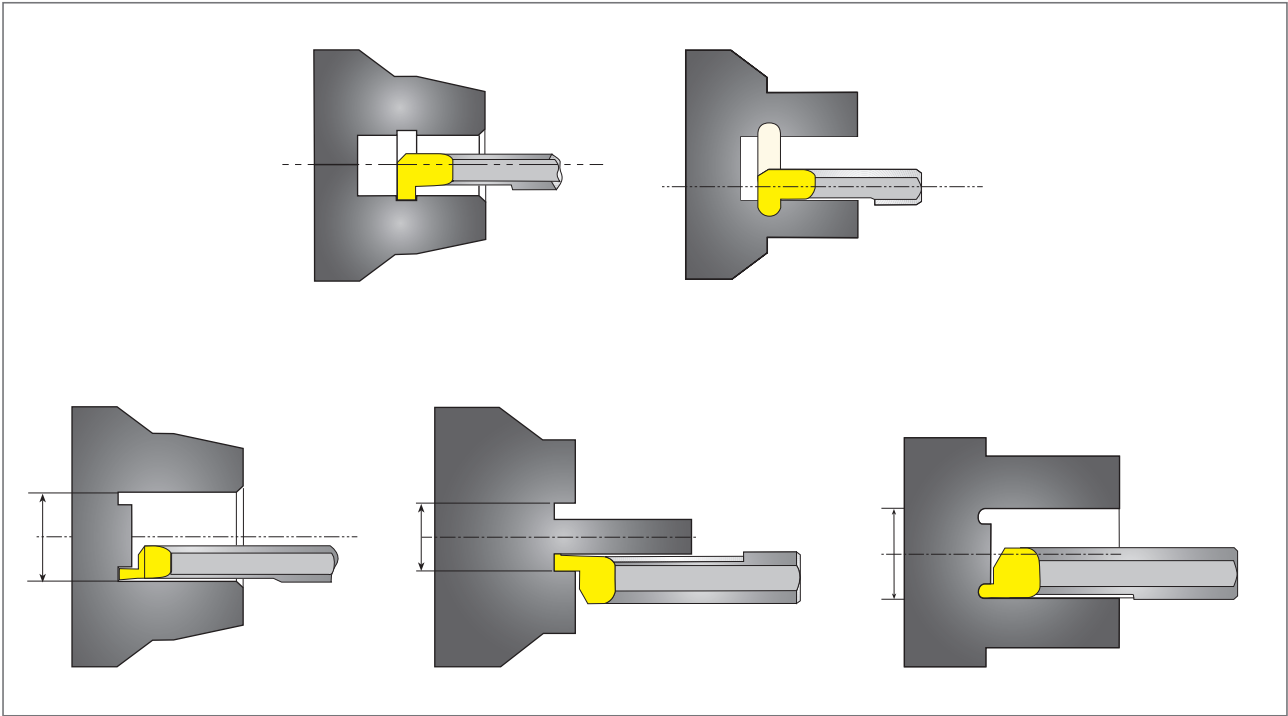

THREAD TURNING

PRODUKT BEZEICHNUNG | PRODUCT DESIGNATION

BEISPIEL | EXAMPLE : TTTR3-0.2R-10L TiAIN

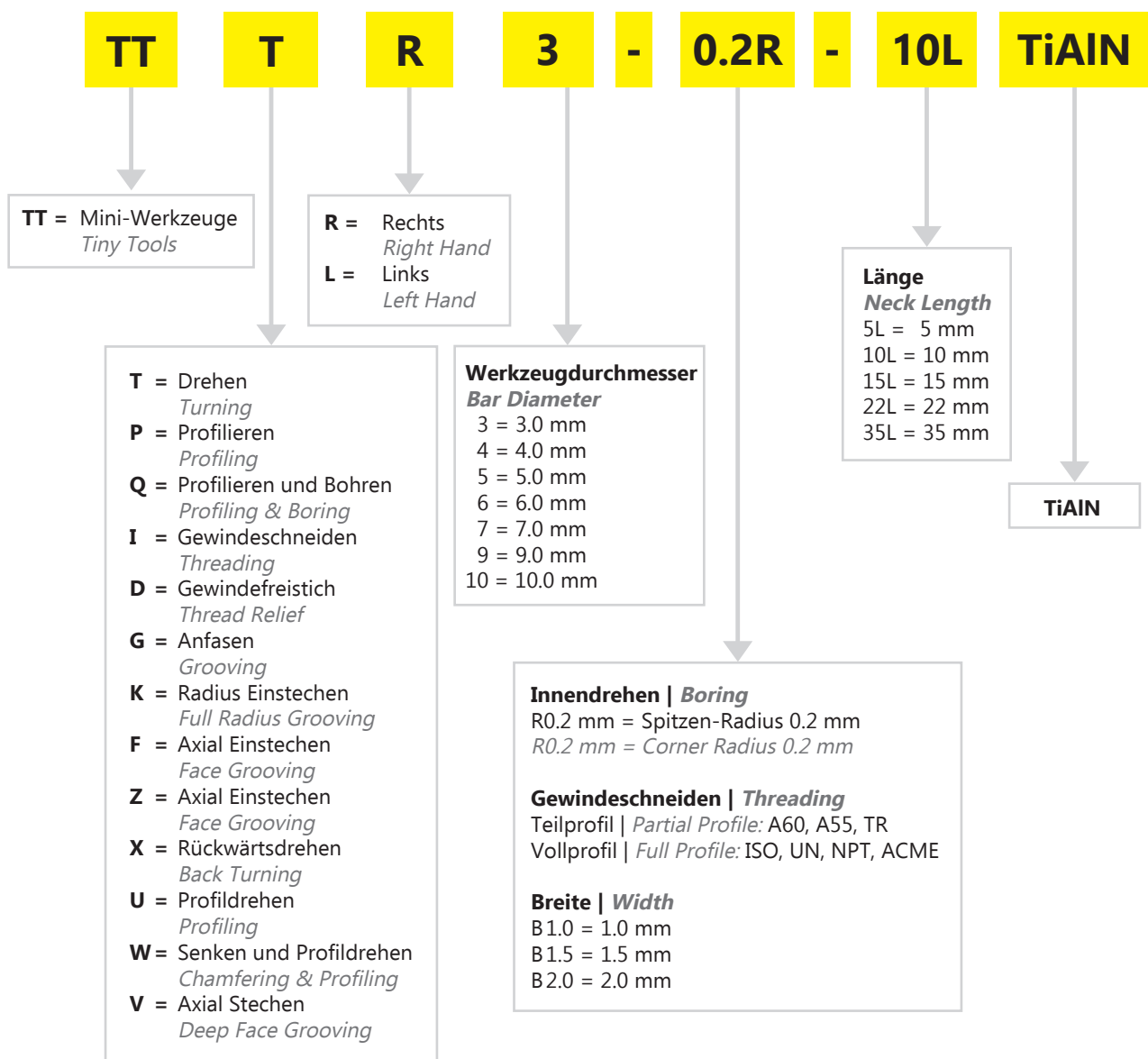

TTTR EINSÄTZE / TTTR BARS

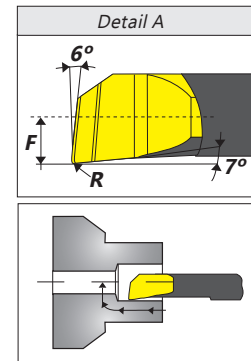
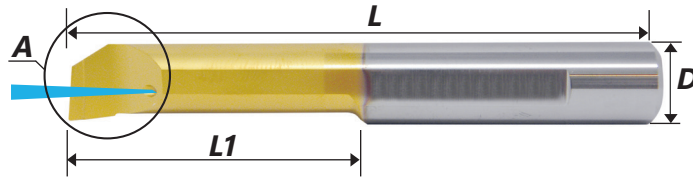

Innendrehen mit Innenkühlung | Boring bars with coolant channel

Artikelnummer (Item Number)	D	Länge (Length) in mm L	Länge (Length) in mm L1	R in mm	F	Halter (Holder)	Min. Bohrungs- durchmesser (Min. Bore Dia.)
TTTR1-0.05R-4L	3.0	39	4	0.05	0.5	TTH20-3	1.0
TTTR1-0.05R-6L	3.0	39	6	0.05	0.5	TTH20-3	1.0
TTTR1.5-0.1R-6L	3.0	39	6	0.10	0.7	TTH20-3	1.5
TTTR2-0.05R-10L	3.0	39	10	0.05	0.8	TTH20-3	2.1
TTTR2-0.15R-5L	3.0	39	5	0.15	0.8	TTH20-3	2.1
TTTR2-0.15R-10L	3.0	39	10	0.15	0.8	TTH20-3	2.1
TTTR3-0.05R-10L	3.0	39	10	0.05	1.3	TTH20-3	3.1
TTTR3-0.05R-15L	3.0	39	15	0.05	1.3	TTH20-3	3.1
TTTR3-0.1R-10L	3.0	39	10	0.10	1.3	TTH20-3	3.1
TTTR3-0.1R-15L	3.0	39	15	0.10	1.3	TTH20-3	3.1
TTTR3-0.2R-10L	3.0	39	10	0.20	1.3	TTH20-3	3.1
TTTR3-0.2R-15L	3.0	39	15	0.20	1.3	TTH20-3	3.1
TTTR4-0.05R-15L	4.0	51	15	0.05	1.7	TTH20-3	4.1
TTTR4-0.1R-10L	4.0	51	10	0.10	1.7	TTH20-4	4.1
TTTR4-0.1R-15L	4.0	51	15	0.10	1.7	TTH20-4	4.1
TTTR4-0.1R-22L	4.0	51	22	0.10	1.7	TTH20-4	4.1
TTTR4-0.2R-10L	4.0	51	10	0.20	1.7	TTH20-4	4.1
TTTR4-0.2R-15L	4.0	51	15	0.20	1.7	TTH20-4	4.1
TTTR4-0.2R-22L	4.0	51	22	0.20	1.7	TTH20-4	4.1
TTTR4-0.2R-30L	4.0	59	30	0.20	1.7	TTH20-4	4.1

TTTR EINSÄTZE / TTTR BARS

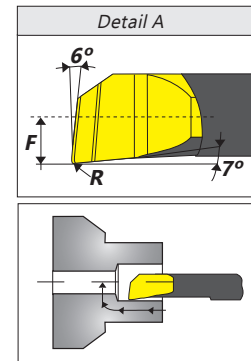
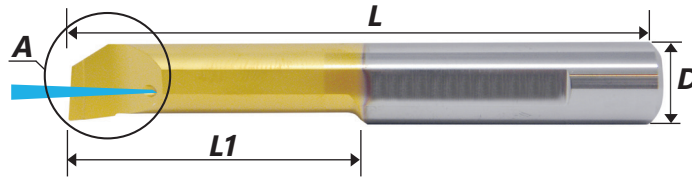

Innendrehen mit Innenkühlung | Boring bars with coolant channel

Artikelnummer (Item Number)	D	Länge (Length) in mm L	Länge (Length) in mm L1	R in mm	F	Halter (Holder)	Min. Bohrungs- durchmesser (Min. Bore Dia.)
TTTR5-0.05R-15L	5.0	51	15	0.05	2.1	TTH20-5	5.1
TTTR5-0.1R-15L	5.0	51	15	0.10	2.1	TTH20-5	5.1
TTTR5-0.1R-22L	5.0	51	22	0.10	2.1	TTH20-5	5.1
TTTR5-0.1R-30L	5.0	76	30	0.10	2.1	TTH20-5	5.1
TTTR5-0.2R-15L	5.0	51	15	0.20	2.1	TTH20-5	5.1
TTTR5-0.2R-22L	5.0	51	22	0.20	2.1	TTH20-5	5.1
TTTR5-0.2R-30L	5.0	76	30	0.20	2.1	TTH20-5	5.1
TTTR6-0.05R-15L	6.0	51	15	0.05	2.8	TTH20-6	6.1
TTTR6-0.05R-22L	6.0	51	22	0.05	2.8	TTH20-6	6.1
TTTR6-0.1R-15L	6.0	51	15	0.10	2.8	TTH20-6	6.1
TTTR6-0.1R-22L	6.0	51	22	0.10	2.8	TTH20-6	6.1
TTTR6-0.2R-15L	6.0	51	15	0.20	2.8	TTH20-6	6.1
TTTR6-0.2R-22L	6.0	51	22	0.20	2.8	TTH20-6	6.1
TTTR6-0.2R-30L	6.0	58	30	0.20	2.8	TTH20-6	6.1
TTTR6-0.2R-35L	6.0	76	35	0.20	2.8	TTH20-6	6.1
TTTR7-0.2R-22L	7.0	62	22	0.20	3.3	TTH20-7	7.1
TTTR7-0.2R-30L	7.0	62	30	0.20	3.3	TTH20-7	7.1
TTTR8-0.2R-15L	8.0	64	15	0.20	3.8	TTH20-8	8.1
TTTR8-0.2R-22L	8.0	64	22	0.20	3.8	TTH20-8	8.1
TTTR8-0.2R-35L	8.0	76	35	0.20	3.8	TTH20-8	8.1
TTTR10-0.2R-35L	10.0	73	35	0.20	4.8	TTH20-10	10.1

TTTL EINSÄTZE / TTTL BARS

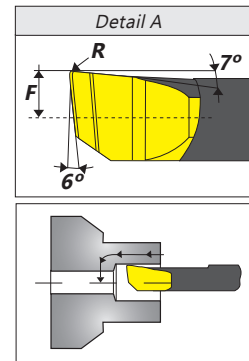
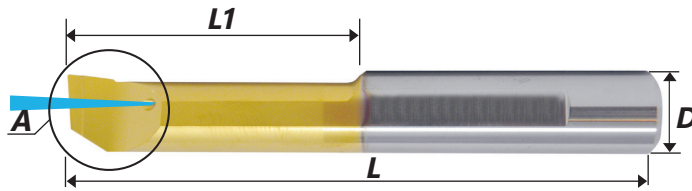

Innendrehen mit Innenkühlung | Boring bars with coolant channel

Artikelnummer (Item Number)	D	Länge (Length) in mm L	Länge (Length) in mm L1	R in mm	F	Halter (Holder)	Min. Bohrungsdurchmesser (Min. Bore Dia.)
TTTL1-0.05R-4L	3.0	39	4	0.05	0.5	TTH20-3	1.0
TTTL1-0.05R-6L	3.0	39	6	0.05	0.5	TTH20-3	1.0
TTTL1.5-0.1R-6L	3.0	39	6	0.10	0.7	TTH20-3	1.5
TTTL2-0.05R-10L	3.0	39	10	0.05	0.8	TTH20-3	2.1
TTTL2-0.15R-5L	3.0	39	5	0.15	0.8	TTH20-3	2.1
TTTL2-0.15R-10L	3.0	39	10	0.15	0.8	TTH20-3	2.1
TTTL3-0.05R-10L	3.0	39	10	0.05	1.3	TTH20-3	3.1
TTTL3-0.05R-15L	3.0	39	15	0.05	1.3	TTH20-3	3.1
TTTL3-0.1R-10L	3.0	39	10	0.10	1.3	TTH20-3	3.1
TTTL3-0.1R-15L	3.0	39	15	0.10	1.3	TTH20-3	3.1
TTTL3-0.2R-10L	3.0	39	10	0.20	1.3	TTH20-3	3.1
TTTL3-0.2R-15L	3.0	39	15	0.20	1.3	TTH20-3	3.1
TTTL4-0.05R-15L	4.0	51	15	0.05	1.7	TTH20-3	4.1
TTTL4-0.1R-10L	4.0	51	10	0.10	1.7	TTH20-4	4.1
TTTL4-0.1R-15L	4.0	51	15	0.10	1.7	TTH20-4	4.1
TTTL4-0.1R-22L	4.0	51	22	0.10	1.7	TTH20-4	4.1
TTTL4-0.2R-10L	4.0	51	10	0.20	1.7	TTH20-4	4.1
TTTL4-0.2R-15L	4.0	51	15	0.20	1.7	TTH20-4	4.1
TTTL4-0.2R-22L	4.0	51	22	0.20	1.7	TTH20-4	4.1
TTTL4-0.2R-30L	4.0	59	30	0.20	1.7	TTH20-4	4.1

TTTL EINSÄTZE / TTTL BARS

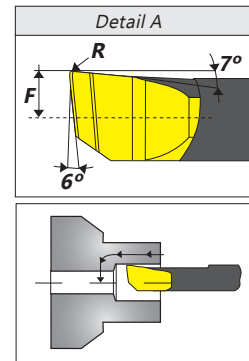
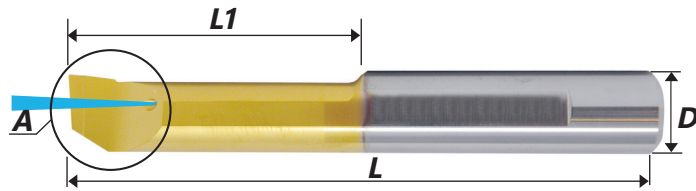

Innendrehen mit Innenkühlung | Boring bars with coolant channel

Artikelnummer (Item Number)	D	Länge (Length) in mm L	Länge (Length) in mm L1	R in mm	F	Halter (Holder)	Min. Bohrungsdurchmesser (Min. Bore Dia.)
TTTL5-0.05R-15L	5.0	51	15	0.05	2.1	TTH20-5	5.1
TTTL5-0.1R-15L	5.0	51	15	0.10	2.1	TTH20-5	5.1
TTTL5-0.1R-22L	5.0	51	22	0.10	2.1	TTH20-5	5.1
TTTL5-0.1R-30L	5.0	76	30	0.10	2.1	TTH20-5	5.1
TTTL5-0.2R-15L	5.0	51	15	0.20	2.1	TTH20-5	5.1
TTTL5-0.2R-22L	5.0	51	22	0.20	2.1	TTH20-5	5.1
TTTL5-0.2R-30L	5.0	76	30	0.20	2.1	TTH20-5	5.1
TTTL6-0.05R-15L	6.0	51	15	0.05	2.8	TTH20-6	6.1
TTTL6-0.05R-22L	6.0	51	22	0.05	2.8	TTH20-6	6.1
TTTL6-0.1R-15L	6.0	51	15	0.10	2.8	TTH20-6	6.1
TTTL6-0.1R-22L	6.0	51	22	0.10	2.8	TTH20-6	6.1
TTTL6-0.2R-15L	6.0	51	15	0.20	2.8	TTH20-6	6.1
TTTL6-0.2R-22L	6.0	51	22	0.20	2.8	TTH20-6	6.1
TTTL6-0.2R-30L	6.0	58	30	0.20	2.8	TTH20-6	6.1
TTTL6-0.2R-35L	6.0	76	35	0.20	2.8	TTH20-6	6.1
TTTL7-0.2R-22L	7.0	62	22	0.20	3.3	TTH20-7	7.1
TTTL7-0.2R-30L	7.0	62	30	0.20	3.3	TTH20-7	7.1
TTTL8-0.2R-15L	8.0	64	15	0.20	3.8	TTH20-8	8.1
TTTL8-0.2R-22L	8.0	64	22	0.20	3.8	TTH20-8	8.1
TTTL8-0.2R-35L	8.0	76	35	0.20	3.8	TTH20-8	8.1
TTTL10-0.2R-35L	10.0	73	35	0.20	4.8	TTH20-10	10.1

TTXR EINSÄTZE / TTXR BARS

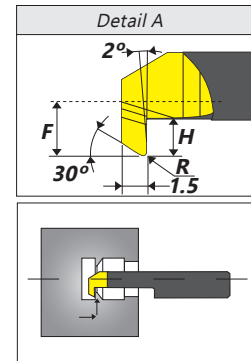
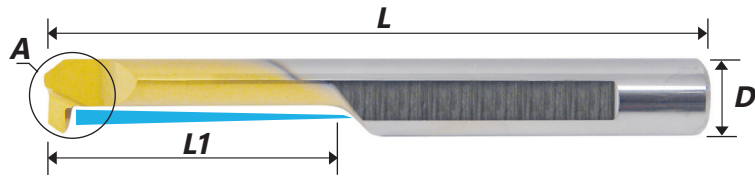

Rückwärtsdrehen | Back Turning

Artikelnummer (Item Number)	D	Länge (Length) in mm L	Länge (Length) in mm L1	R in mm	F	H	Halter (Holder)	Min. Bohrungs- durchmesser (Min. Bore Dia.)
TTXR4-0.1R-10L	4.0	51	10	0.10	1.3	0.5	TTH20-4	3.1
TTXR4-0.15R-10L	4.0	51	10	0.15	1.6	0.8	TTH20-4	4.1
TTXR4-0.15R-15L	4.0	51	15	0.15	1.6	0.8	TTH20-4	4.1
TTXR5-0.2R-15L	5.0	51	15	0.20	2.2	1.0	TTH20-5	5.1
TTXR5-0.2R-22L	5.0	51	22	0.20	2.2	1.0	TTH20-5	5.1
TTXR6-0.2R-15L	6.0	51	15	0.20	2.8	1.8	TTH20-6	6.1
TTXR6-0.2R-22L	6.0	51	22	0.20	2.8	1.8	TTH20-6	6.1

TTXL EINSÄTZE | TTXL BARS

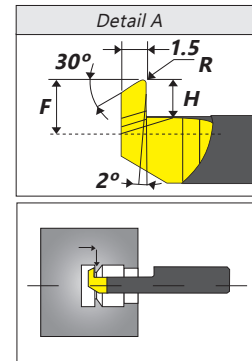
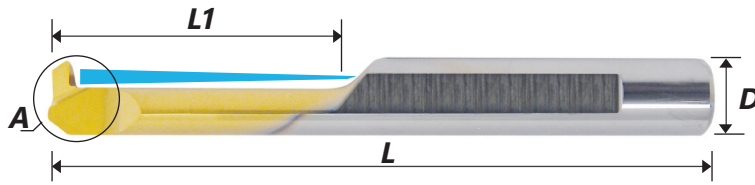

Rückwärtsdrehen | Back Turning

Artikelnummer (Item Number)	D	Länge (Length) in mm L	Länge (Length) in mm L1	R in mm	F	H	Halter (Holder)	Min. Bohrungs- durchmesser (Min. Bore Dia.)
TTXL4-0.1R-10L	4.0	51	10	0.10	1.3	0.5	TTH20-4	3.1
TTXL4-0.15R-10L	4.0	51	10	0.15	1.6	0.8	TTH20-4	4.1
TTXL4-0.15R-15L	4.0	51	15	0.15	1.6	0.8	TTH20-4	4.1
TTXL5-0.2R-15L	5.0	51	15	0.20	2.2	1.0	TTH20-5	5.1
TTXL5-0.2R-22L	5.0	51	22	0.20	2.2	1.0	TTH20-5	5.1
TTXL6-0.2R-15L	6.0	51	15	0.20	2.8	1.8	TTH20-6	6.1
TTXL6-0.2R-22L	6.0	51	22	0.20	2.8	1.8	TTH20-6	6.1

TTPR EINSÄTZE / TTPR BARS

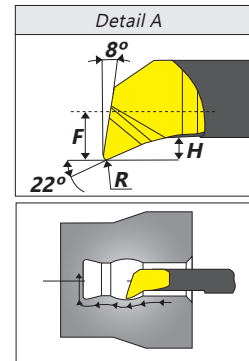
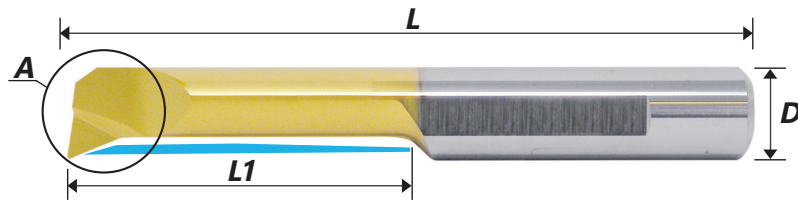

Profildrehen und Bohren | Profiling and Boring

Artikelnummer (Item Number)	D	Länge (Length) in mm L	Länge (Length) in mm L1	R in mm	F	H	Halter (Holder)	Min. Bohrungs- durchmesser (Min. Bore Dia.)
TTPR1-0.05R-4L	3.0	39	4	0.05	0.5	0.2	TTH20-3	1.0
TTPR1-0.05R-8L	3.0	39	8	0.05	0.5	0.2	TTH20-3	1.0
TTPR1.5-0.05R-10L	3.0	39	10	0.05	0.7	0.3	TTH20-3	1.5
TTPR1.5-0.1R-6L	3.0	39	6	0.10	0.7	0.3	TTH20-3	1.5
TTPR1.5-0.1R-10L	3.0	39	10	0.10	0.7	0.3	TTH20-3	1.5
TTPR2-0.05R-10L	3.0	39	10	0.05	0.8	0.5	TTH20-3	2.1
TTPR2-0.1R-10L	3.0	39	10	0.10	0.8	0.5	TTH20-3	2.1
TTPR2-0.15R-5L	3.0	39	5	0.15	0.8	0.5	TTH20-3	2.1
TTPR2-0.15R-10L	3.0	39	10	0.15	0.8	0.5	TTH20-3	2.1
TTPR2-0.15R-15L	3.0	39	15	0.15	0.8	0.5	TTH20-3	2.1
TTPR3-0.05R-10L	3.0	39	10	0.05	1.3	0.7	TTH20-3	3.1
TTPR3-0.05R-15L	3.0	39	15	0.05	1.3	0.7	TTH20-3	3.1
TTPR3-0.1R-15L	3.0	39	15	0.10	1.3	0.7	TTH20-3	3.1
TTPR3-0.1R-22L	3.0	47	22	0.10	1.3	0.7	TTH20-3	3.1
TTPR3-0.2R-10L	3.0	39	10	0.20	1.3	0.7	TTH20-3	3.1
TTPR3-0.2R-15L	3.0	39	15	0.20	1.3	0.7	TTH20-3	3.1
TTPR3-0.2R-22L	3.0	47	22	0.20	1.3	0.7	TTH20-3	3.1
TTPR4-0.1R-10L	4.0	51	10	0.10	1.7	0.8	TTH20-4	4.1
TTPR4-0.1R-15L	4.0	51	15	0.10	1.7	0.8	TTH20-4	4.1
TTPR4-0.1R-22L	4.0	51	22	0.10	1.7	0.8	TTH20-4	4.1
TTPR4-0.2R-10L	4.0	51	10	0.20	1.7	0.8	TTH20-4	4.1
TTPR4-0.2R-15L	4.0	51	15	0.20	1.7	0.8	TTH20-4	4.1
TTPR4-0.2R-22L	4.0	51	22	0.20	1.7	0.8	TTH20-4	4.1

TTPR EINSÄTZE / TTPR BARS

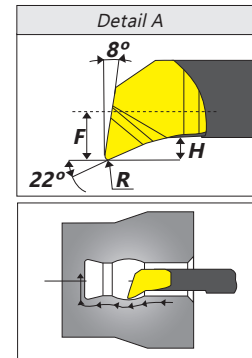
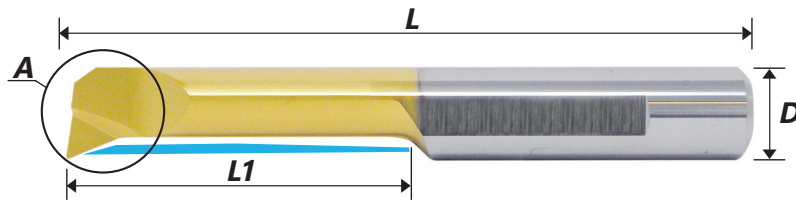

Profildrehen und Bohren | Profiling and Boring

Artikelnummer (Item Number)	D	Länge (Length) in mm L	Länge (Length) in mm L1	R in mm	F	H	Halter (Holder)	Min. Bohrungs- durchmesser (Min. Bore Dia.)
TTPR5-0.1R-22L	5.0	51	22	0.10	2.1	1.2	TTH20-5	5.1
TTPR5-0.1R-30L	5.0	76	30	0.10	2.1	1.2	TTH20-5	5.1
TTPR5-0.2R-10L	5.0	51	10	0.20	2.1	1.2	TTH20-5	5.1
TTPR5-0.2R-15L	5.0	51	15	0.20	2.1	1.2	TTH20-5	5.1
TTPR5-0.2R-22L	5.0	51	22	0.20	2.1	1.2	TTH20-5	5.1
TTPR5-0.2R-30L	5.0	76	30	0.20	2.1	1.2	TTH20-5	5.1
TTPR6-0.2R-15L	6.0	51	15	0.20	2.8	1.4	TTH20-6	6.1
TTPR6-0.2R-22L	6.0	51	22	0.20	2.8	1.4	TTH20-6	6.1
TTPR6-0.2R-30L	6.0	76	30	0.20	2.8	1.4	TTH20-6	6.1
TTPR7-0.2R-22L	7.0	62	22	0.20	3.3	1.5	TTH20-7	7.1
TTPR7-0.2R-30L	7.0	62	30	0.20	3.3	1.5	TTH20-7	7.1
TTPR7-0.2R-35L	7.0	62	35	0.20	3.3	1.5	TTH20-7	7.1
TTPR8-0.2R-15L	8.0	64	15	0.20	3.8	1.6	TTH20-8	8.1
TTPR8-0.2R-22L	8.0	64	22	0.20	3.8	1.6	TTH20-8	8.1
TTPR8-0.2R-35L	8.0	76	35	0.20	3.8	1.6	TTH20-8	8.1
TTPR10-0.2R-35L	10.0	73	35	0.20	4.8	2.0	TTH20-10	10.1

TTPL EINSÄTZE / TTPL BARS

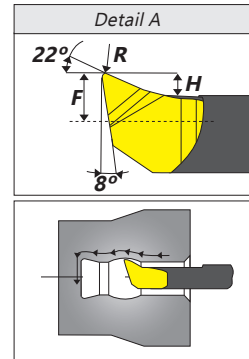
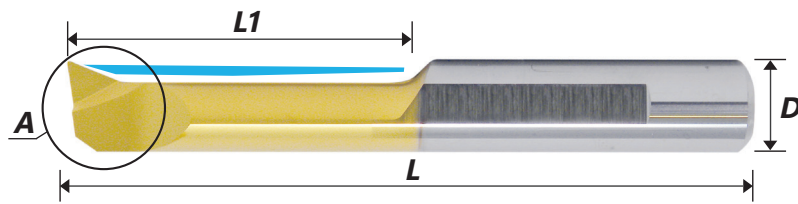

Profildrehen und Bohren | Profiling and Boring

Artikelnummer (Item Number)	D	Länge (Length) in mm L	Länge (Length) in mm L1	R in mm	F	H	Halter (Holder)	Min. Bohrungs- durchmesser (Min. Bore Dia.)
TTPL1-0.05R-4L	3.0	39	4	0.05	0.5	0.2	TTH20-3	1.0
TTPL1-0.05R-8L	3.0	39	8	0.05	0.5	0.2	TTH20-3	1.0
TTPL1.5-0.05R-10L	3.0	39	10	0.05	0.7	0.3	TTH20-3	1.5
TTPL1.5-0.1R-6L	3.0	39	6	0.10	0.7	0.3	TTH20-3	1.5
TTPL1.5-0.1R-10L	3.0	39	10	0.10	0.7	0.3	TTH20-3	1.5
TTPL2-0.05R-10L	3.0	39	10	0.05	0.8	0.5	TTH20-3	2.1
TTPL2-0.1R-10L	3.0	39	10	0.10	0.8	0.5	TTH20-3	2.1
TTPL2-0.15R-5L	3.0	39	5	0.15	0.8	0.5	TTH20-3	2.1
TTPL2-0.15R-10L	3.0	39	10	0.15	0.8	0.5	TTH20-3	2.1
TTPL2-0.15R-15L	3.0	39	15	0.15	0.8	0.5	TTH20-3	2.1
TTPL3-0.05R-10L	3.0	39	10	0.05	1.3	0.7	TTH20-3	3.1
TTPL3-0.05R-15L	3.0	39	15	0.05	1.3	0.7	TTH20-3	3.1
TTPL3-0.1R-15L	3.0	39	15	0.10	1.3	0.7	TTH20-3	3.1
TTPL3-0.1R-22L	3.0	47	22	0.10	1.3	0.7	TTH20-3	3.1
TTPL3-0.2R-10L	3.0	39	10	0.20	1.3	0.7	TTH20-3	3.1
TTPL3-0.2R-15L	3.0	39	15	0.20	1.3	0.7	TTH20-3	3.1
TTPL3-0.2R-22L	3.0	47	22	0.20	1.3	0.7	TTH20-3	3.1
TTPL4-0.1R-10L	4.0	51	10	0.10	1.7	0.8	TTH20-4	4.1
TTPL4-0.1R-15L	4.0	51	15	0.10	1.7	0.8	TTH20-4	4.1
TTPL4-0.1R-22L	4.0	51	22	0.10	1.7	0.8	TTH20-4	4.1
TTPL4-0.2R-10L	4.0	51	10	0.20	1.7	0.8	TTH20-4	4.1
TTPL4-0.2R-15L	4.0	51	15	0.20	1.7	0.8	TTH20-4	4.1
TTPL4-0.2R-22L	4.0	51	22	0.20	1.7	0.8	TTH20-4	4.1

TTPL EINSÄTZE / TTPL BARS

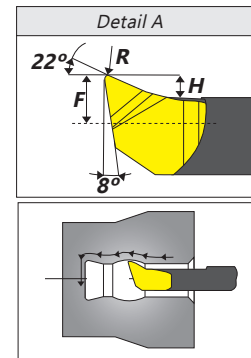
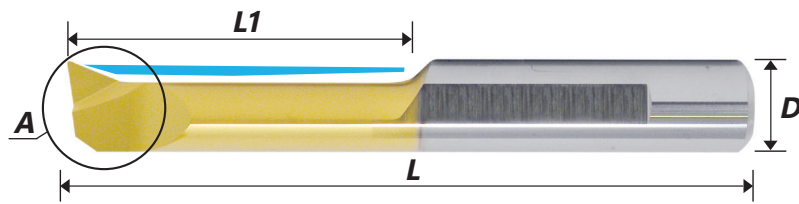

Profildrehen und Bohren | Profiling and Boring

Artikelnummer (Item Number)	D	Länge (Length) in mm L	Länge (Length) in mm L1	R in mm	F	H	Halter (Holder)	Min. Bohrungs- durchmesser (Min. Bore Dia.)
TTPL5-0.1R-22L	5.0	51	22	0.10	2.1	1.2	TTH20-5	5.1
TTPL5-0.1R-30L	5.0	76	30	0.10	2.1	1.2	TTH20-5	5.1
TTPL5-0.2R-10L	5.0	51	10	0.20	2.1	1.2	TTH20-5	5.1
TTPL5-0.2R-15L	5.0	51	15	0.20	2.1	1.2	TTH20-5	5.1
TTPL5-0.2R-22L	5.0	51	22	0.20	2.1	1.2	TTH20-5	5.1
TTPL5-0.2R-30L	5.0	76	30	0.20	2.1	1.2	TTH20-5	5.1
TTPL6-0.2R-15L	6.0	51	15	0.20	2.8	1.4	TTH20-6	6.1
TTPL6-0.2R-22L	6.0	51	22	0.20	2.8	1.4	TTH20-6	6.1
TTPL6-0.2R-30L	6.0	76	30	0.20	2.8	1.4	TTH20-6	6.1
TTPL7-0.2R-22L	7.0	62	22	0.20	3.3	1.5	TTH20-7	7.1
TTPL7-0.2R-30L	7.0	62	30	0.20	3.3	1.5	TTH20-7	7.1
TTPL7-0.2R-35L	7.0	62	35	0.20	3.3	1.5	TTH20-7	7.1
TTPL8-0.2R-15L	8.0	64	15	0.20	3.8	1.6	TTH20-8	8.1
TTPL8-0.2R-22L	8.0	64	22	0.20	3.8	1.6	TTH20-8	8.1
TTPL8-0.2R-35L	8.0	76	35	0.20	3.8	1.6	TTH20-8	8.1
TTPL10-0.2R-35L	10.0	73	35	0.20	4.8	2.0	TTH20-10	10.1

TTUR EINSÄTZE / TTUR BARS

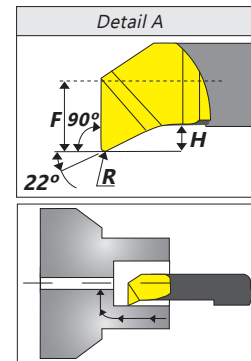
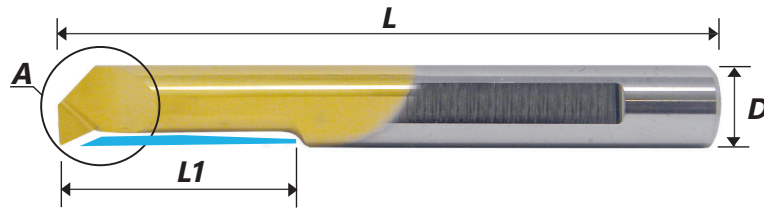

Profildrehen, 90° Plandrehen | Profiling, 90° Face Cutting

Artikelnummer (Item Number)	D	Länge (Length) in mm L	Länge (Length) in mm L1	R in mm	F	H	Halter (Holder)	Min. Bohrungs- durchmesser (Min. Bore Dia.)
TTUR3-0.05R-10L	3.0	39	10	0.05	1.3	0.4	TTH20-3	3.1
TTUR3-0.05R-15L	3.0	39	15	0.05	1.3	0.4	TTH20-3	3.1
TTUR4-0.1R-10L	4.0	51	10	0.10	1.7	0.5	TTH20-4	4.1
TTUR4-0.1R-15L	4.0	51	15	0.10	1.7	0.5	TTH20-4	4.1
TTUR5-0.15R-15L	5.0	51	15	0.15	2.1	0.7	TTH20-5	5.1
TTUR5-0.15R-22L	5.0	51	22	0.15	2.1	0.7	TTH20-5	5.1
TTUR6-0.15R-15L	6.0	51	15	0.15	2.8	0.9	TTH20-6	6.1
TTUR6-0.15R-22L	6.0	51	22	0.15	2.8	0.9	TTH20-6	6.1
TTUR8-0.2R-22L	8.0	64	22	0.20	3.8	1.1	TTH20-8	8.1

TTUL EINSÄTZE / TTUL BARS

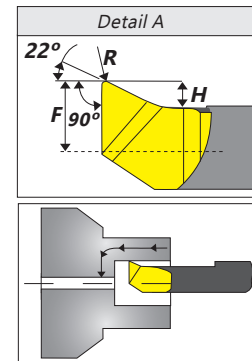
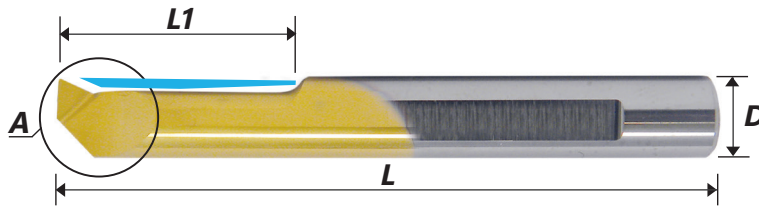

Profildrehen, 90° Plandrehen | Profiling, 90° Face Cutting

Artikelnummer (Item Number)	D	Länge (Length) in mm L	Länge (Length) in mm L1	R in mm	F	H	Halter (Holder)	Min. Bohrungs- durchmesser (Min. Bore Dia.)
TTUL3-0.05R-10L	3.0	39	10	0.05	1.3	0.4	TTH20-3	3.1
TTUL3-0.05R-15L	3.0	39	15	0.05	1.3	0.4	TTH20-3	3.1
TTUL4-0.1R-10L	4.0	51	10	0.10	1.7	0.5	TTH20-4	4.1
TTUL4-0.1R-15L	4.0	51	15	0.10	1.7	0.5	TTH20-4	4.1
TTUL5-0.15R-15L	5.0	51	15	0.15	2.1	0.7	TTH20-5	5.1
TTUL5-0.15R-22L	5.0	51	22	0.15	2.1	0.7	TTH20-5	5.1
TTUL6-0.15R-15L	6.0	51	15	0.15	2.8	0.9	TTH20-6	6.1
TTUL6-0.15R-22L	6.0	51	22	0.15	2.8	0.9	TTH20-6	6.1
TTUL8-0.2R-22L	8.0	64	22	0.20	3.8	1.1	TTH20-8	8.1

TTQR EINSÄTZE / TTQR BARS

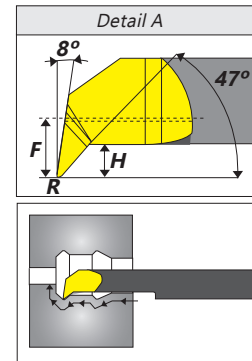
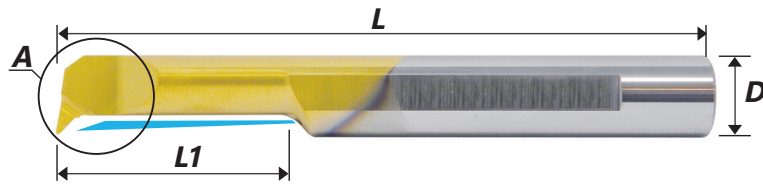

Profildrehen und Bohren | Profiling and Boring

Artikelnummer (Item Number)	D	Länge (Length) in mm L	Länge (Length) in mm L1	R in mm	F	H	Halter (Holder)	Min. Bohrungs- durchmesser (Min. Bore Dia.)
TTQR4-0.1R-22L	4.0	22	51	0.10	1.8	0.8	TTH20-4	4.1
TTQR4-0.2R-10L	4.0	10	51	0.20	1.8	0.8	TTH20-4	4.1
TTQR4-0.2R-15L	4.0	15	51	0.20	1.8	0.8	TTH20-4	4.1
TTQR4-0.2R-22L	4.0	22	51	0.20	1.8	0.8	TTH20-4	4.1
TTQR5-0.2R-15L	5.0	15	51	0.20	2.3	1.0	TTH20-5	5.1
TTQR5-0.2R-22L	5.0	22	51	0.20	2.3	1.0	TTH20-5	5.1
TTQR6-0.2R-15L	6.0	15	51	0.20	2.8	1.4	TTH20-6	6.1
TTQR6-0.2R-22L	6.0	22	51	0.20	2.8	1.4	TTH20-6	6.1
TTQR6-0.2R-30L	6.0	30	58	0.20	2.8	1.4	TTH20-6	6.1
TTQR8-0.2R-22L	8.0	22	64	0.20	3.8	1.6	TTH20-8	8.1
TTQR8-0.2R-27L	8.0	27	64	0.20	3.8	2.0	TTH20-8	8.1

TTQL EINSÄTZE / TTQL BARS

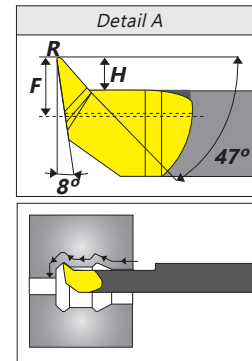
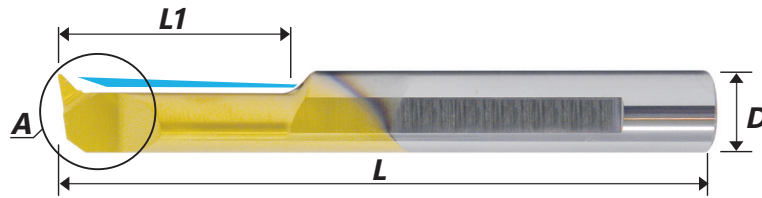

Profildrehen und Bohren | Profiling and Boring

Artikelnummer (Item Number)	D	Länge (Length) in mm	Länge (Length) in mm $L1$	R in mm	F	H	Halter (Holder)	Min. Bohrungs- durchmesser (Min. Bore Dia.)
TTQL4-0.1R-22L	4.0	22	51	0.10	1.8	0.8	TTH20-4	4.1
TTQL4-0.2R-10L	4.0	10	51	0.20	1.8	0.8	TTH20-4	4.1
TTQL4-0.2R-15L	4.0	15	51	0.20	1.8	0.8	TTH20-4	4.1
TTQL4-0.2R-22L	4.0	22	51	0.20	1.8	0.8	TTH20-4	4.1
TTQL5-0.2R-15L	5.0	15	51	0.20	2.3	1.0	TTH20-5	5.1
TTQL5-0.2R-22L	5.0	22	51	0.20	2.3	1.0	TTH20-5	5.1
TTQL6-0.2R-15L	6.0	15	51	0.20	2.8	1.4	TTH20-6	6.1
TTQL6-0.2R-22L	6.0	22	51	0.20	2.8	1.4	TTH20-6	6.1
TTQL6-0.2R-30L	6.0	30	58	0.20	2.8	1.4	TTH20-6	6.1
TTQL8-0.2R-22L	8.0	22	64	0.20	3.8	1.6	TTH20-8	8.1
TTQL8-0.2R-27L	8.0	27	64	0.20	3.8	2.0	TTH20-8	8.1

TTIR EINSÄTZE / TTIR BARS

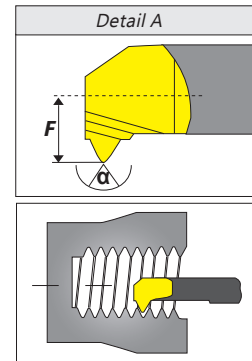
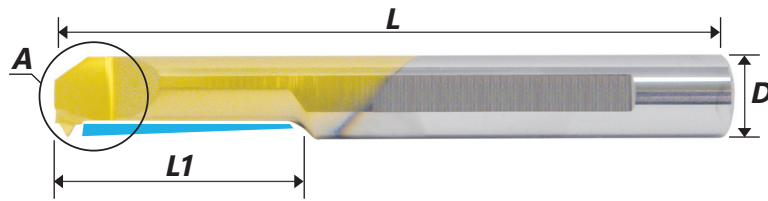

Gewindeschneiden, Teilprofil 55° Gewinde | Threading, Partial Profile 55°

Artikelnummer (Item Number)	Steigung (Pitch Range)		Länge (Length) in mm L	Länge (Length) in mm L1	D in mm	F	α	Halter (Holder)	Min. Bohrungs- durchmesser (Min. Bore Dia.)
	mm	Gänge/ Zoll (TPI)							
TTIR3-A55-15L	0.5 - 1.0	48-24	39	15	3.0	1.4	55	TTH20-3	3.2
TTIR4-A55-15L	0.5 - 1.0	48-24	51	15	4.0	1.8	55	TTH20-4	4.1
TTIR5-A55-15L	0.5 - 1.25	48-20	51	15	5.0	2.3	55	TTH20-5	5.1
TTIR5-A55-22L	0.5 - 1.25	48-20	51	22	5.0	2.3	55	TTH20-5	5.1
TTIR6-A55-15L	0.5 - 1.5	48-16	51	15	6.0	2.6	55	TTH20-6	6.0
TTIR6-A55-22L	0.5 - 1.5	48-16	51	22	6.0	2.6	55	TTH20-6	6.0

TTIL EINSÄTZE / TTIL BARS

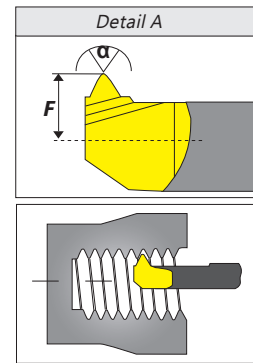
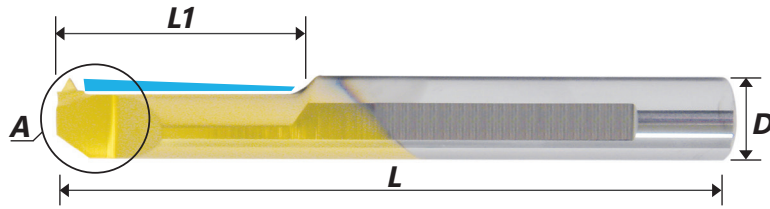

Gewindeschneiden, Teilprofil 55° Gewinde | Threading, Partial Profile 55°

Artikelnummer (Item Number)	Steigung (Pitch Range)		Länge (Length) in mm L	Länge (Length) in mm L1	D in mm	F	α	Halter (Holder)	Min. Bohrungs- durchmesser (Min. Bore Dia.)
	mm	Gänge/ Zoll (TPI)							
TTIL3-A55-15L	0.5 - 1.0	48-24	39	15	3.0	1.4	55	TTH20-3	3.2
TTIL4-A55-15L	0.5 - 1.0	48-24	51	15	4.0	1.8	55	TTH20-4	4.1
TTIL5-A55-15L	0.5 - 1.25	48-20	51	15	5.0	2.3	55	TTH20-5	5.1
TTIL5-A55-22L	0.5 - 1.25	48-20	51	22	5.0	2.3	55	TTH20-5	5.1
TTIL6-A55-15L	0.5 - 1.5	48-16	51	15	6.0	2.6	55	TTH20-6	6.0
TTIL6-A55-22L	0.5 - 1.5	48-16	51	22	6.0	2.6	55	TTH20-6	6.0

TTIR EINSÄTZE / TTIR BARS

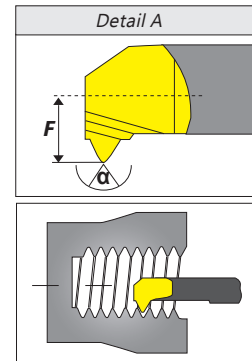
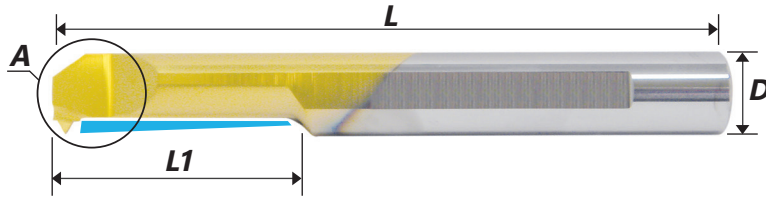

Gewindeschneiden, Teilprofil 60° Gewinde | Threading, Partial Profile 60°

Artikelnummer (Item Number)	Steigung (Pitch Range)		Länge (Length) in mm L	Länge (Length) in mm L1	D in mm	F	α	Halter (Holder)	Min. Bohrungs- durchmesser (Min. Bore Dia.)
	mm	Gänge/ Zoll (TPI)							
TTIR1-A60-5L	0.25 - 0.35	100 -72	39	4.8	3.0	0.55	60	TTH20-3	1.2
TTIR1.5-A60-6L	0.35 - 0.45	72-56	39	6.3	3.0	0.65	60	TTH20-3	1.4
TTIR2-A60-8L	0.45 - 0.7	56-32	39	8	3.0	1.0	60	TTH20-3	2.1
TTIR3-A60-15L	0.7 - 1.0	32-24	39	15	3.0	1.4	60	TTH20-3	3.2
TTIR4-A60-15L	0.8 - 1.0	32-24	51	15	4.0	1.8	60	TTH20-4	4.1
TTIR5-A60-15L	1.0 - 1.25	24-20	51	15	5.0	2.3	60	TTH20-5	5.1
TTIR5-A60-22L	1.0 - 1.25	24-20	51	22	5.0	2.3	60	TTH20-5	5.1
TTIR6-A60-15L	1.0 - 1.5	24-16	51	15	6.0	2.6	60	TTH20-6	6.0
TTIR6-A60-22L	1.0 - 1.5	24-16	51	22	6.0	2.6	60	TTH20-6	6.0
TTIR8-A60-22L	1.0 - 2.0	24-13	64	22	8.0	3.6	60	TTH20-8	8.0

TTIL EINSÄTZE / TTIL BARS

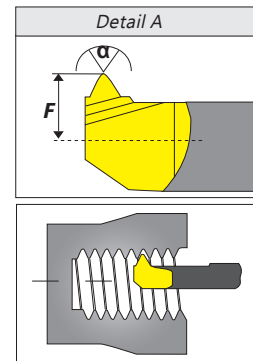
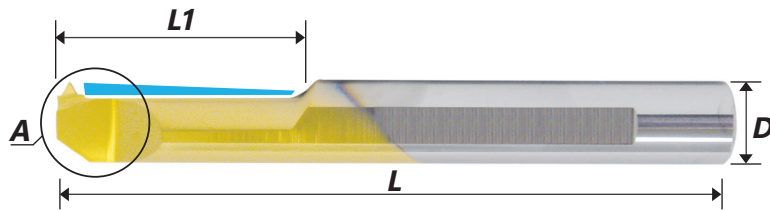

Gewindeschneiden, Teilprofil 60° Gewinde | Threading, Partial Profile 60°

Artikelnummer (Item Number)	Steigung (Pitch Range)		Länge (Length) in mm L	Länge (Length) in mm L1	D in mm	F	α	Halter (Holder)	Min. Bohrungs- durchmesser (Min. Bore Dia.)
	mm	Gänge/ Zoll (TPI)							
TTIL1-A60-5L	0.25 - 0.35	100 -72	39	4.8	3.0	0.55	60	TTH20-3	1.2
TTIL1.5-A60-6L	0.35 - 0.45	72-56	39	6.3	3.0	0.65	60	TTH20-3	1.4
TTIL2-A60-8L	0.45 - 0.7	56-32	39	8	3.0	1.0	60	TTH20-3	2.1
TTIL3-A60-15L	0.7 - 1.0	32-24	39	15	3.0	1.4	60	TTH20-3	3.2
TTIL4-A60-15L	0.8 - 1.0	32-24	51	15	4.0	1.8	60	TTH20-4	4.1
TTIL5-A60-15L	1.0 - 1.25	24-20	51	15	5.0	2.3	60	TTH20-5	5.1
TTIL5-A60-22L	1.0 - 1.25	24-20	51	22	5.0	2.3	60	TTH20-5	5.1
TTIL6-A60-15L	1.0 - 1.5	24-16	51	15	6.0	2.6	60	TTH20-6	6.0
TTIL6-A60-22L	1.0 - 1.5	24-16	51	22	6.0	2.6	60	TTH20-6	6.0
TTIL8-A60-22L	1.0 - 2.0	24-13	64	22	8.0	3.6	60	TTH20-8	8.0

TTIR EINSÄTZE | TTIR BARS

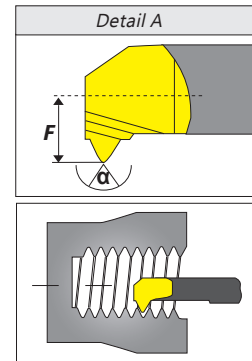
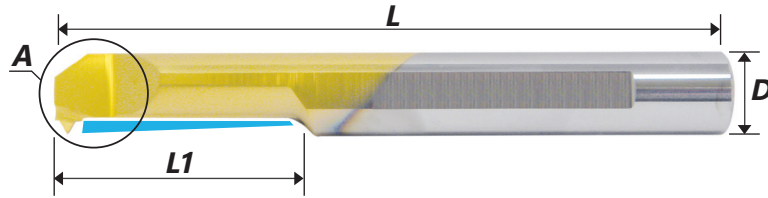

Gewindeschneiden, Vollprofil ISO 60° Gewinde | Threading, Full Profile ISO 60°

Artikelnummer (Item Number)	Gewinde (Thread)	Länge (Length) in mm L	Länge (Length) in mm L1	D in mm	F	Halter (Holder)	Min. Bohrungs- durchmesser (Min. Bore Dia.)
TTIR3-0.5ISO-10L	M3 x 0.5	39	10	3.0	1.0	TTH20-3	2.4
TTIR3-0.5ISO-15L	M4 x 0.5	39	15	3.0	1.4	TTH20-3	3.2
TTIR3-0.7ISO-15L	M4 x 0.7	39	15	3.0	1.4	TTH20-3	3.2
TTIR3-0.75ISO-15L	M4.5 x 0.75	39	15	3.0	1.4	TTH20-3	3.2
TTIR4-0.5ISO-15L	M5 x 0.5	51	15	4.0	1.8	TTH20-4	4.1
TTIR4-0.75ISO-15L	M5 x 0.75	51	15	4.0	1.8	TTH20-4	4.1
TTIR4-0.8ISO-15L	M5 x 0.8	51	15	4.0	1.8	TTH20-4	4.1
TTIR5-1.0ISO-15L	M6 x 1.0	51	15	5.0	2.2	TTH20-5	4.9
TTIR6-1.25ISO-22L	M8 x 1.25	51	22	6.0	2.8	TTH20-6	6.1

TTIL EINSÄTZE / TTIL BARS

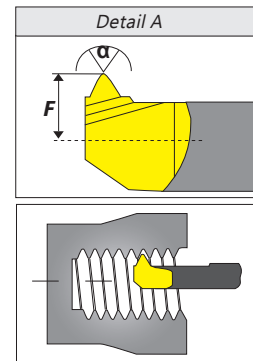
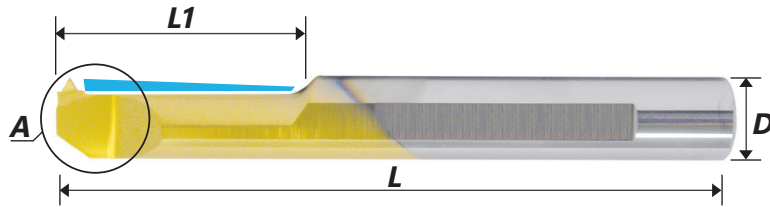

Gewindeschneiden, Vollprofil ISO 60° Gewinde | Threading, Full Profile ISO 60°

Artikelnummer (Item Number)	Gewinde (Thread)	Länge (Length) in mm L	Länge (Length) in mm L1	D in mm	F	Halter (Holder)	Min. Bohrungs- durchmesser (Min. Bore Dia.)
TTIL3-0.5ISO-10L	M3 x 0.5	39	10	3.0	1.0	TTH20-3	2.4
TTIL3-0.5ISO-15L	M4 x 0.5	39	15	3.0	1.4	TTH20-3	3.2
TTIL3-0.7ISO-15L	M4 x 0.7	39	15	3.0	1.4	TTH20-3	3.2
TTIL3-0.75ISO-15L	M4.5 x 0.75	39	15	3.0	1.4	TTH20-3	3.2
TTIL4-0.5ISO-15L	M5 x 0.5	51	15	4.0	1.8	TTH20-4	4.1
TTIL4-0.75ISO-15L	M5 x 0.75	51	15	4.0	1.8	TTH20-4	4.1
TTIL4-0.8ISO-15L	M5 x 0.8	51	15	4.0	1.8	TTH20-4	4.1
TTIL5-1.0ISO-15L	M6 x 1.0	51	15	5.0	2.2	TTH20-5	4.9
TTIL6-1.25ISO-22L	M8 x 1.25	51	22	6.0	2.8	TTH20-6	6.1

TTIR EINSÄTZE | TTIR BARS

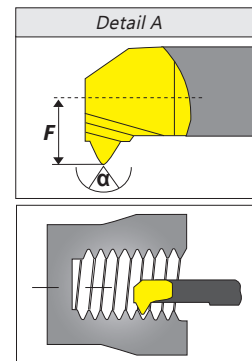
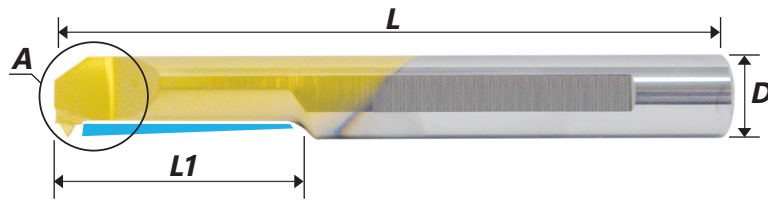

Gewindeschneiden, Vollprofil UN 60° Gewinde | Threading, Full Profile UN 60°

Artikelnummer (Item Number)	Gewinde (Thread)	Länge (Length) in mm L	Länge (Length) in mm L1	D in mm	F	Halter (Holder)	Min. Bohrungs- durchmesser (Min. Bore Dia.)
TTIR3-32UN-L10	6-32UNC	39	10	3.0	1.0	TTH20-3	2.7
TTIR3-36UN-15L	8-36UNF	39	15	3.0	1.4	TTH20-3	3.2
TTIR3-32UN-15L	8-32UNC	39	15	3.0	1.4	TTH20-3	3.2
TTIR4-36UN-15L	12-36UNS	51	15	4.0	1.8	TTH20-4	4.1
TTIR4-32UN-15L	12-32UNEF	51	15	4.0	1.8	TTH20-4	4.1
TTIR5-28UN-15L	1/4-28UNF	51	15	5.0	2.2	TTH20-5	4.9
TTIR5-20UN-18L	1/4-20UNC	51	18	5.0	2.3	TTH20-5	5.0
TTIR6-24UN-18L	5/16-24UNF	51	18	6.0	2.8	TTH20-6	6.5
TTIR6-18UN-18L	5/16-18UNC	51	18	6.0	2.8	TTH20-6	6.2

TTIL EINSÄTZE / TTIL BARS

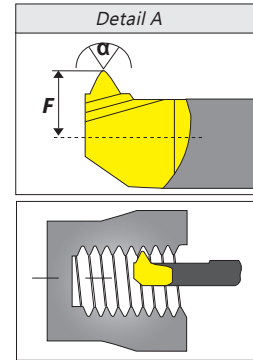
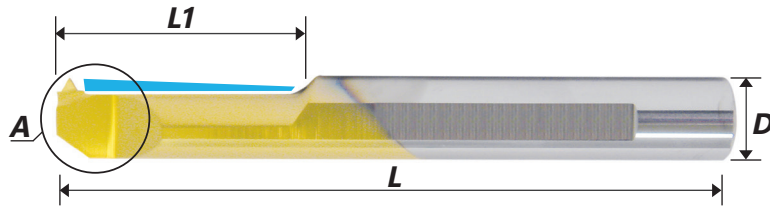

Gewindeschneiden, Vollprofil UN 60° Gewinde | Threading, Full Profile UN 60°

Artikelnummer (Item Number)	Gewinde (Thread)	Länge (Length) in mm L	Länge (Length) in mm L1	D in mm	F	Halter (Holder)	Min. Bohrungs- durchmesser (Min. Bore Dia.)
TTIL3-32UN-L10	6-32UNC	39	10	3.0	1.0	TTH20-3	2.7
TTIL3-36UN-15L	8-36UNF	39	15	3.0	1.4	TTH20-3	3.2
TTIL3-32UN-15L	8-32UNC	39	15	3.0	1.4	TTH20-3	3.2
TTIL4-36UN-15L	12-36UNS	51	15	4.0	1.8	TTH20-4	4.1
TTIL4-32UN-15L	12-32UNEF	51	15	4.0	1.8	TTH20-4	4.1
TTIL5-28UN-15L	1/4-28UNF	51	15	5.0	2.2	TTH20-5	4.9
TTIL5-20UN-18L	1/4-20UNC	51	18	5.0	2.3	TTH20-5	5.0
TTIL6-24UN-18L	5/16-24UNF	51	18	6.0	2.8	TTH20-6	6.5
TTIL6-18UN-18L	5/16-18UNC	51	18	6.0	2.8	TTH20-6	6.2

TTIR EINSÄTZE / TTIR BARS

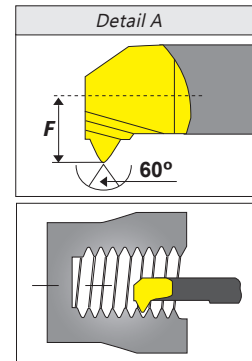
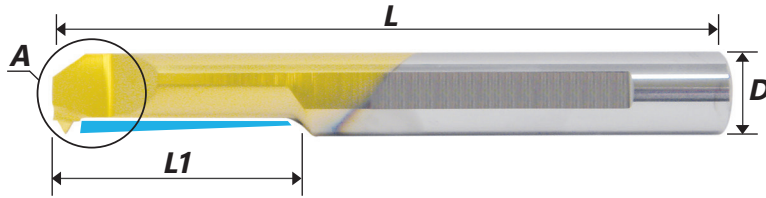

Gewindeschneiden, Vollprofil NPT 60° Gewinde | Threading, Full Profile NPT 60°

Artikelnummer (Item Number)	Steigung (Pitch) Gänge/ Zoll (TPI)	Länge (Length) in mm L	Länge (Length) in mm L1	D in mm	F	Gewinde (Thread Size)	Halter (Holder)	Min. Bohr. (Min. Bore Dia.)
TTIR6-27NPT-15L	27	51	15	6.0	2.6	1/16x27NPT 1/8x27NPT	TTH20-6	5.9

TTIL EINSÄTZE / TTIL BARS

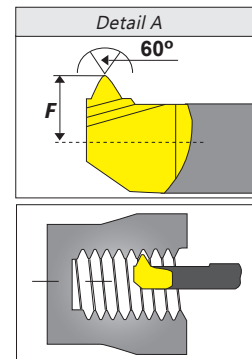
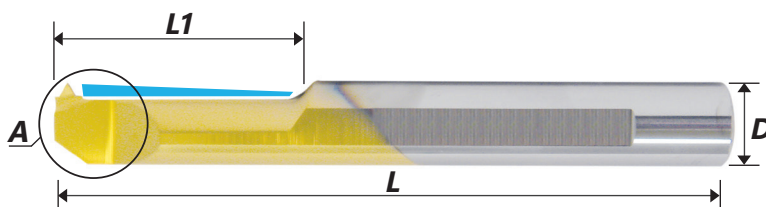

Gewindeschneiden, Vollprofil NPT 60° Gewinde | Threading, Full Profile NPT 60°

Artikelnummer (Item Number)	Steigung (Pitch) Gänge/ Zoll (TPI)	Länge (Length) in mm L	Länge (Length) in mm L1	D in mm	F	Gewinde (Thread Size)	Halter (Holder)	Min. Bohr. (Min. Bore Dia.)
TTIL6-27NPT-15L	27	51	15	6.0	2.6	1/16x27NPT 1/8x27NPT	TTH20-6	5.9

TTIR EINSÄTZE / TTIR BARS

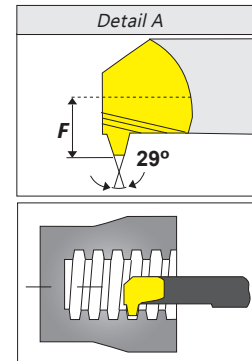
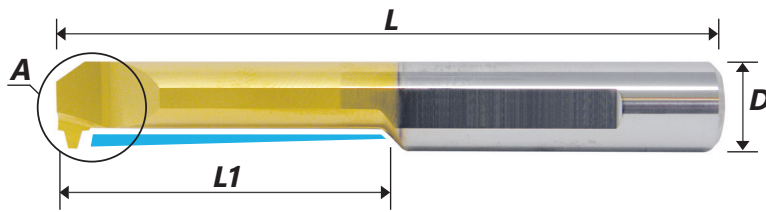

ACME

Artikelnummer (Item Number)	Steigung (Pitch) Gänge/ Zoll (TPI)	Länge (Length) in mm L	Länge (Length) in mm L1	D in mm	F	Gewinde (Thread Size)	Halter (Holder)	Min. Bohr. (Min.Bore Dia.)
TTIR4-16ACME-15L	16	51	15	4.0	1.8	1/4 x 16	TTH20-4	4.6
TTIR6-14ACME-20L	14	51	20	6.0	2.8	5/16 x 14	TTH20-6	6.0
TTIR7-12ACME-22L	12	62	22	7.0	3.3	3/8 x 12	TTH20-7	7.2
TTIR8-10ACME-30L	10	76	30	8.0	3.8	1/2 x 10	TTH20-8	10.0
TTIR10-8ACME-35L	8	73	35	10.0	4.8	5/8 x 8	TTH20-10	12.5
TTIR10-6ACME-45L	6	105	45	10.0	4.8	3/4 x 6 7/8 x 6	TTH20-10	14.6
TTIR10-5ACME-52L	5	105	52	10.0	4.8	1 x 5	TTH20-10	20.0

TTIL EINSÄTZE / TTIL BARS

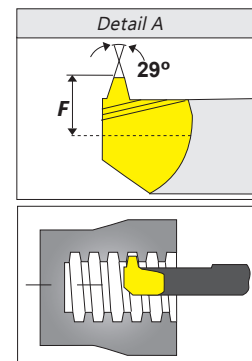
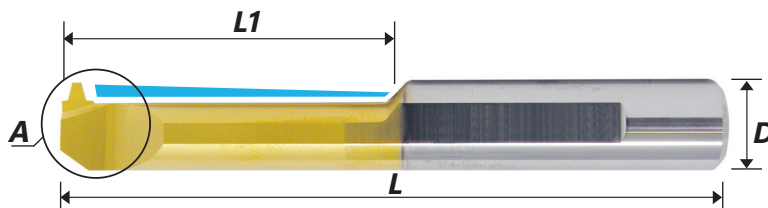

ACME

Artikelnummer (Item Number)	Steigung (Pitch) Gänge/ Zoll (TPI)	Länge (Length) in mm L	Länge (Length) in mm L1	D in mm	F	Gewinde (Thread Size)	Halter (Holder)	Min. Bohr. (Min.Bore Dia.)
TTIL4-16ACME-15L	16	51	15	4.0	1.8	1/4 x 16	TTH20-4	4.6
TTIL6-14ACME-20L	14	51	20	6.0	2.8	5/16 x 14	TTH20-6	6.0
TTIL7-12ACME-22L	12	62	22	7.0	3.3	3/8 x 12	TTH20-7	7.2
TTIL8-10ACME-30L	10	76	30	8.0	3.8	1/2 x 10	TTH20-8	10.0
TTIL10-8ACME-35L	8	73	35	10.0	4.8	5/8 x 8	TTH20-10	12.5
TTIL10-6ACME-45L	6	105	45	10.0	4.8	3/4 x 6 7/8 x 6	TTH20-10	14.6
TTIL10-5ACME-52L	5	105	52	10.0	4.8	1 x 5	TTH20-10	20.0

TTIR EINSÄTZE / TTIR BARS

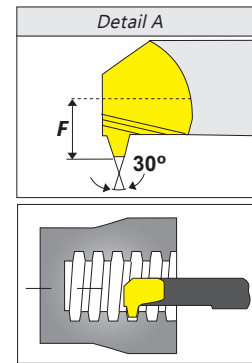
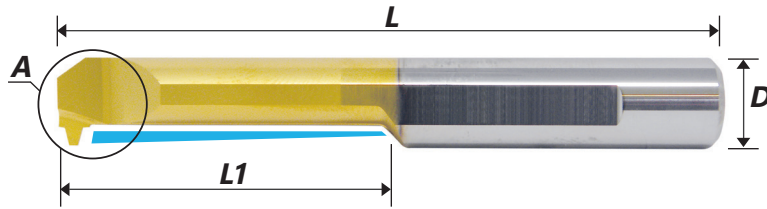

Teilprofil Trapez - DIN 103 | Partial Profile Trapez - DIN 103

Artikelnummer (Item Number)	Steigung (Pitch) Gänge/ Zoll (TPI)	Länge (Length) in mm L	Länge (Length) in mm L1	D in mm	F	Gewinde (Thread Size)	Halter (Holder)	Min. Bohr. (Min. Bore Dia.)
TTIR6-1.5TR-22L	1.5	51	22	6.0	2.8	Tr 8 x 1.5	TTH20-6	6.4
						Tr 9 x 1.5		
						Tr 10 x 1.5		
TTIR7-2TR-25L	2	62	25	7.0	3.2	Tr 9 x 2	TTH20-7	6.9
						Tr 10 x 2		
						Tr 11 x 2		
						Tr 12 x 2		
TTIR10-2TR-35L	2	73	35	10.0	4.8	Tr 14 x 2	TTH20-10	11.0
						Tr 16 x 2		
						Tr 18 x 2		
						Tr 20 x 2		
TTIR7-3TR-35L	3	62	35	7.0	3.3	Tr 11 x 3	TTH20-7	7.5
						Tr 12 x 3		
TTIR10-3TR-35L	3	73	35	10.0	4.8	Tr 14 x 3	TTH20-10	10.5
						Tr 22 x 3		
						Tr 24 x 3		
						Tr 26 x 3		
						Tr 28 x 3		
TTIR10-4TR-45L	4	105	45	10.0	4.8	Tr 16 x 4	TTH20-10	11.5
						Tr 18 x 4		
						Tr 20 x 4		
TTIR10-5TR-55L	4	105	55	10.0	4.8	Tr 22 x 5	TTH20-10	11.0
						Tr 24 x 5		
						Tr 28 x 5		

TTIL EINSÄTZE / TTIL BARS

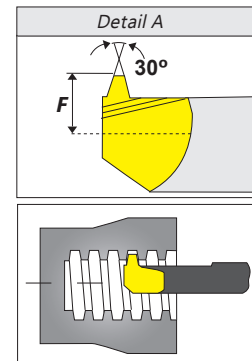
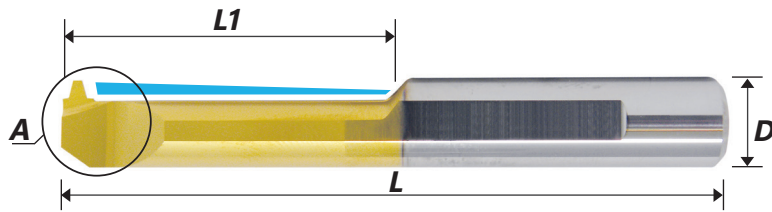

Teilprofil Trapez - DIN 103 | Partial Profile Trapez - DIN 103

Artikelnummer (Item Number)	Steigung (Pitch) Gänge/ Zoll (TPI)	Länge (Length) in mm L	Länge (Length) in mm L1	D in mm	F	Gewinde (Thread Size)	Halter (Holder)	Min. Bohr. (Min. Bore Dia.)
TTIL6-1.5TR-22L	1.5	51	22	6.0	2.8	Tr 8 x 1.5	TTH20-6	6.4
						Tr 9 x 1.5		
						Tr 10 x 1.5		
TTIL7-2TR-25L	2	62	25	7.0	3.2	Tr 9 x 2	TTH20-7	6.9
						Tr 10 x 2		
						Tr 11 x 2		
						Tr 12 x 2		
TTIL10-2TR-35L	2	73	35	10.0	4.8	Tr 14 x 2	TTH20-10	11.0
						Tr 16 x 2		
						Tr 18 x 2		
						Tr 20 x 2		
TTIL7-3TR-35L	3	62	35	7.0	3.3	Tr 11 x 3	TTH20-7	7.5
						Tr 12 x 3		
TTIL10-3TR-35L	3	73	35	10.0	4.8	Tr 14 x 3	TTH20-10	10.5
						Tr 22 x 3		
						Tr 24 x 3		
						Tr 26 x 3		
TTIL10-4TR-45L	4	105	45	10.0	4.8	Tr 28 x 3	TTH20-10	11.5
						Tr 16 x 4		
						Tr 18 x 4		
TTIL10-5TR-55L	4	105	55	10.0	4.8	Tr 20 x 4	TTH20-10	11.0
						Tr 22 x 5		
						Tr 24 x 5		
						Tr 28 x 5		

TTDR EINSÄTZE / TTDR BARS

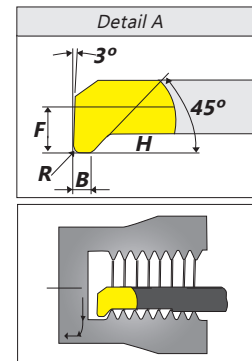
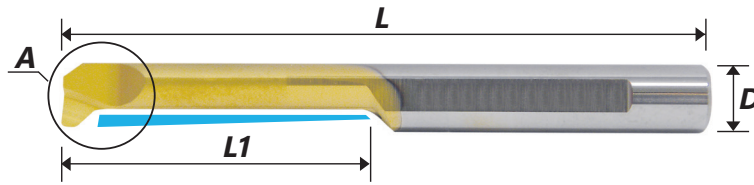

Gewindefreistich, Anfasen und Einstechen | Thread Relief, Chamfering and Grooving

Artikelnummer (Item Number)	Länge (Length) in mm L	Länge (Length) in mm L1	D in mm	B	R	H	F	Halter (Holder)	Min. Bohr. (Min. Bore Dia.)
TTDR4-0.5R-18L	51	18	4.0	1.5	0.5	0.8	1.8	TTH20-4	4.1
TTDR5-0.5R-24L	51	24	5.0	1.5	0.5	1.2	2.3	TTH20-5	5.1
TTDR6-0.5R-27L	58	27	6.0	1.5	0.5	1.4	2.8	TTH20-6	6.1

TTDL EINSÄTZE / TTDL BARS

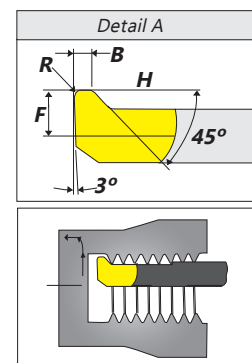
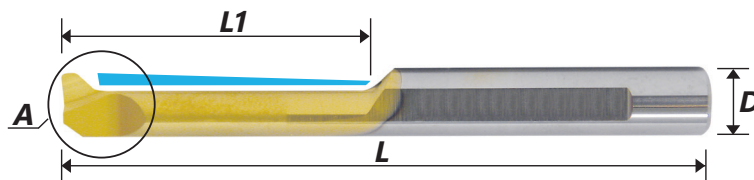

Gewindefreistich, Anfasen und Einstechen | Thread Relief, Chamfering and Grooving

Artikelnummer (Item Number)	Länge (Length) in mm L	Länge (Length) in mm L1	D in mm	B	R	H	F	Halter (Holder)	Min. Bohr. (Min. Bore Dia.)
TTDL4-0.5L-18L	51	18	4.0	1.5	0.5	0.8	1.8	TTH20-4	4.1
TTDL5-0.5L-24L	51	24	5.0	1.5	0.5	1.2	2.3	TTH20-5	5.1
TTDL6-0.5L-27L	58	27	6.0	1.5	0.5	1.4	2.8	TTH20-6	6.1

TTCR EINSÄTZE / TTCR BARS

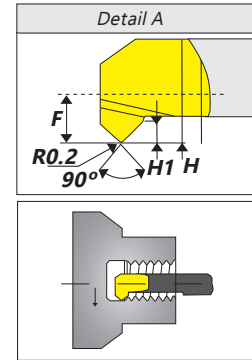
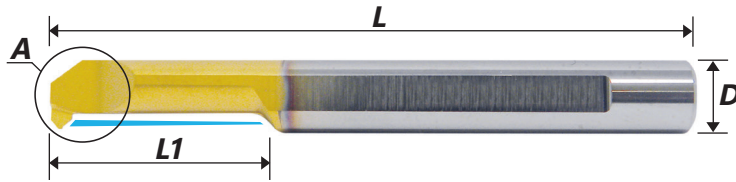

Anfasen und Bohren | Chamfering and Boring

Artikelnummer (Item Number)	Länge (Length) in mm L	Länge (Length) in mm L1	D in mm	F	H	H1	R	Halter (Holder)	Min. Bohr. (Min. Bore Dia.)
TTCR3-0.2R-10L	39	10	3.0	1.3	0.7	0.3	0.20	TTH20-3	3.1
TTCR4-0.2R-15L	51	15	4.0	1.7	0.8	0.4	0.20	TTH20-4	4.1
TTCR5-0.2R-15L	51	15	5.0	2.1	1.2	0.7	0.20	TTH20-5	5.1
TTCR6-0.2R-15L	51	15	6.0	2.8	1.4	0.7	0.20	TTH20-6	6.1
TTCR7-0.2R-20L	62	20	7.0	3.3	1.5	0.8	0.20	TTH20-7	7.1

TTCL EINSÄTZE / TTCL BARS

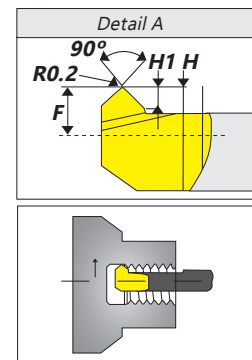
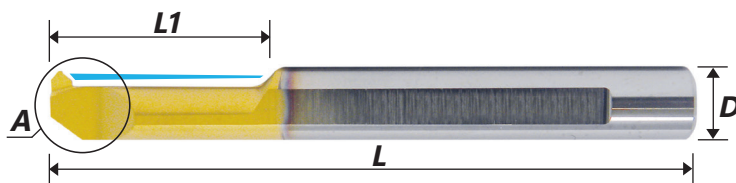

Anfasen und Bohren | Chamfering and Boring

Artikelnummer (Item Number)	Länge (Length) in mm L	Länge (Length) in mm L1	D in mm	F	H	H1	R	Halter (Holder)	Min. Bohr. (Min. Bore Dia.)
TTCL3-0.2R-10L	39	10	3.0	1.3	0.7	0.3	0.20	TTH20-3	3.1
TTCL4-0.2R-15L	51	15	4.0	1.7	0.8	0.4	0.20	TTH20-4	4.1
TTCL5-0.2R-15L	51	15	5.0	2.1	1.2	0.7	0.20	TTH20-5	5.1
TTCL6-0.2R-15L	51	15	6.0	2.8	1.4	0.7	0.20	TTH20-6	6.1
TTCL7-0.2R-20L	62	20	7.0	3.3	1.5	0.8	0.20	TTH20-7	7.1

TTWR EINSÄTZE / TTWR BARS

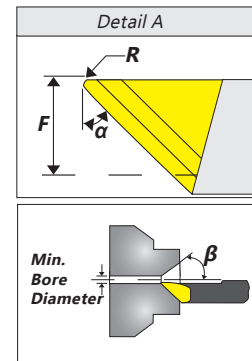
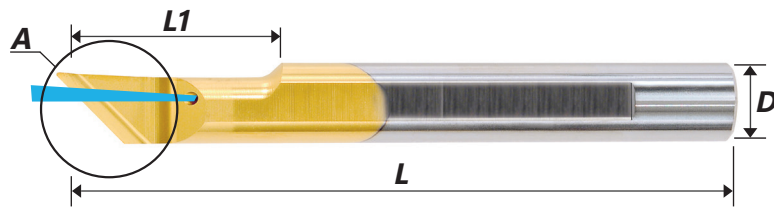

45° Senken und Profildrehen mit Innenkühlung | 45° Chamfering and Profiling with internal coolant

Artikelnummer (Item Number)	Länge (Length) in mm L	Länge (Length) in mm L1	D in mm	F	α	β	R	Halter (Holder)	Min. Bohr. (Min. Bore Dia.)
TTWR6-0.2R-A90	51	15.0	6.0	2.3	45°	45°	0.20	TTH20-6	1.0
TTWR6-0.2R-A60	51	15.0	6.0	2.3	60°	30°	0.20	TTH20-6	1.0
TTWR6-0.4R-A90	51	22.0	6.0	2.3	45°	45°	0.40	TTH20-6	6.0
TTWR6-0.4R-A60	51	22.0	6.0	2.3	60°	30°	0.40	TTH20-6	6.0

TTWL EINSÄTZE / TTWL BARS

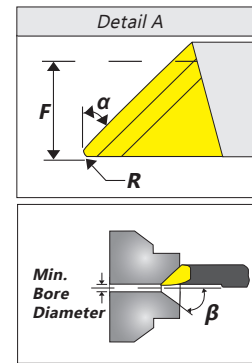
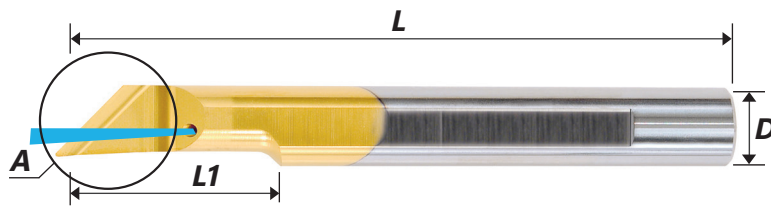

45° Senken und Profildrehen mit Innenkühlung | Chamfering and Profiling with internal coolant

Artikelnummer (Item Number)	Länge (Length) in mm L	Länge (Length) in mm L1	D in mm	F	α	β	R	Halter (Holder)	Min. Bohr. (Min. Bore Dia.)
TTWL6-0.2R-A90	51	15.0	6.0	2.3	45°	45°	0.20	TTH20-6	1.0
TTWL6-0.2R-A60	51	15.0	6.0	2.3	60°	30°	0.20	TTH20-6	1.0
TTWL6-0.4R-A90	51	22.0	6.0	2.3	45°	45°	0.40	TTH20-6	6.0
TTWL6-0.4R-A60	51	22.0	6.0	2.3	60°	30°	0.40	TTH20-6	6.0

TTGR EINSÄTZE / TTGR BARS

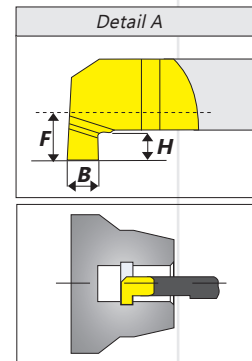
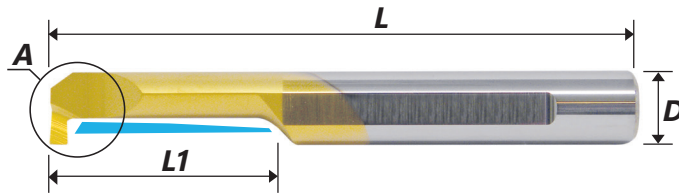

Einstecken | Grooving

Artikelnummer (Item Number)	Länge (Length) in mm L	Länge (Length) in mm L1	D in mm	B	H	F	Halter (Holder)	Min. Bohr. (Min. Bore Dia.)
TTGR3-0.7B-10L	39	10	3.0	0.7	0.6	1.3	TTH20-3	3.1
TTGR4-0.5B-10L	51	10	4.0	0.5	0.5	1.7	TTH20-4	4.1
TTGR4-0.7B-10L	51	10	4.0	0.7	0.6	1.7	TTH20-4	4.1
TTGR4-1.0B-10L	51	10	4.0	1.0	1.0	1.7	TTH20-4	4.1
TTGR4-1.0B-15L	51	15	4.0	1.0	1.0	1.7	TTH20-4	4.1
TTGR4-1.5B-10L	51	10	4.0	1.5	1.0	1.7	TTH20-4	4.1
TTGR5-1.0B-15L	51	15	5.0	1.0	1.2	2.3	TTH20-5	5.1
TTGR5-1.0B-22L	51	22	5.0	1.0	1.2	2.3	TTH20-5	5.1
TTGR5-1.5B-15L	51	15	5.0	1.5	1.2	2.3	TTH20-5	5.1
TTGR5-1.5B-22L	51	22	5.0	1.5	1.2	2.3	TTH20-5	5.1
TTGR5-2.0B-15L	51	15	5.0	2.0	1.2	2.3	TTH20-5	5.1
TTGR5-2.0B-22L	51	22	5.0	2.0	1.2	2.3	TTH20-5	5.1
TTGR6-1.0B-15L	51	15	6.0	1.0	1.4	2.8	TTH20-6	6.1
TTGR6-1.0B-22L	51	22	6.0	1.0	1.4	2.8	TTH20-6	6.1
TTGR6-1.5B-15L	51	15	6.0	1.5	1.4	2.8	TTH20-6	6.1
TTGR6-1.5B-22L	51	22	6.0	1.5	1.4	2.8	TTH20-6	6.1
TTGR6-2.0B-15L	51	15	6.0	2.0	1.4	2.8	TTH20-6	6.1
TTGR6-2.0B-22L	51	22	6.0	2.0	1.4	2.8	TTH20-6	6.1
TTGR6-1.0B-17L	51	17	6.0	1.0	1.8	2.8	TTH20-6	6.1
TTGR6-1.5B-17L	51	17	6.0	1.5	1.8	2.8	TTH20-6	6.1
TTGR6-2.0B-17L	51	17	6.0	2.0	1.8	2.8	TTH20-6	6.1
TTGR7-1.0B-15L	62	15	7.0	1.0	2.5	3.3	TTH20-7	7.1
TTGR7-1.0B-22L	62	22	7.0	1.0	2.5	3.3	TTH20-7	7.1
TTGR7-1.0B-30L	62	30	7.0	1.0	2.5	3.3	TTH20-7	7.1
TTGR7-1.5B-15L	62	15	7.0	1.5	2.5	3.3	TTH20-7	7.1
TTGR7-1.5B-22L	62	22	7.0	1.5	2.5	3.3	TTH20-7	7.1
TTGR7-1.5B-30L	62	30	7.0	1.5	2.5	3.3	TTH20-7	7.1
TTGR7-2.0B-15L	62	15	7.0	2.0	2.5	3.3	TTH20-7	7.1
TTGR7-2.0B-22L	62	22	7.0	2.0	2.5	3.3	TTH20-7	7.1
TTGR7-2.0B-30L	62	30	7.0	2.0	2.5	3.3	TTH20-7	7.1
TTGR8-1.0B-22L	64	22	8.0	1.0	1.7	3.8	TTH20-8	8.1
TTGR8-1.5B-22L	64	22	8.0	1.5	1.7	3.8	TTH20-8	8.1
TTGR8-2.0B-22L	64	22	8.0	2.0	2.6	3.8	TTH20-8	8.1

TTGL EINSÄTZE / TTGL BARS

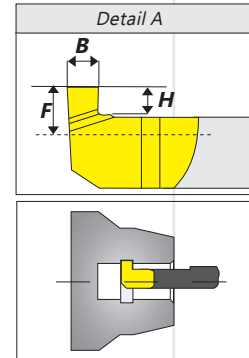
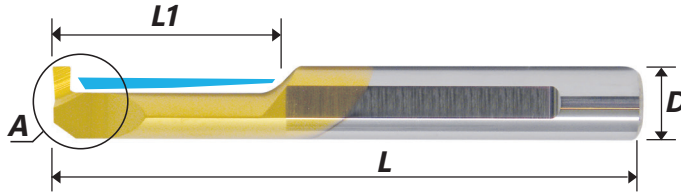

Einstecken | Grooving

Artikelnummer (Item Number)	Länge (Length) in mm L	Länge (Length) in mm L1	D in mm	B	H	F	Halter (Holder)	Min. Bohr. (Min. Bore Dia.)
TTGL3-0.7B-10L	39	10	3.0	0.7	0.6	1.3	TTH20-3	3.1
TTGL4-0.5B-10L	51	10	4.0	0.5	0.5	1.7	TTH20-4	4.1
TTGL4-0.7B-10L	51	10	4.0	0.7	0.6	1.7	TTH20-4	4.1
TTGL4-1.0B-10L	51	10	4.0	1.0	1.0	1.7	TTH20-4	4.1
TTGL4-1.0B-15L	51	15	4.0	1.0	1.0	1.7	TTH20-4	4.1
TTGL4-1.5B-10L	51	10	4.0	1.5	1.0	1.7	TTH20-4	4.1
TTGL5-1.0B-15L	51	15	5.0	1.0	1.2	2.3	TTH20-5	5.1
TTGL5-1.0B-22L	51	22	5.0	1.0	1.2	2.3	TTH20-5	5.1
TTGL5-1.5B-15L	51	15	5.0	1.5	1.2	2.3	TTH20-5	5.1
TTGL5-1.5B-22L	51	22	5.0	1.5	1.2	2.3	TTH20-5	5.1
TTGL5-2.0B-15L	51	15	5.0	2.0	1.2	2.3	TTH20-5	5.1
TTGL5-2.0B-22L	51	22	5.0	2.0	1.2	2.3	TTH20-5	5.1
TTGL6-1.0B-15L	51	15	6.0	1.0	1.4	2.8	TTH20-6	6.1
TTGL6-1.0B-22L	51	22	6.0	1.0	1.4	2.8	TTH20-6	6.1
TTGL6-1.5B-15L	51	15	6.0	1.5	1.4	2.8	TTH20-6	6.1
TTGL6-1.5B-22L	51	22	6.0	1.5	1.4	2.8	TTH20-6	6.1
TTGL6-2.0B-15L	51	15	6.0	2.0	1.4	2.8	TTH20-6	6.1
TTGL6-2.0B-22L	51	22	6.0	2.0	1.4	2.8	TTH20-6	6.1
TTGL6-1.0B-17L	51	17	6.0	1.0	1.8	2.8	TTH20-6	6.1
TTGL6-1.5B-17L	51	17	6.0	1.5	1.8	2.8	TTH20-6	6.1
TTGL6-2.0B-17L	51	17	6.0	2.0	1.8	2.8	TTH20-6	6.1
TTGL7-1.0B-15L	62	15	7.0	1.0	2.5	3.3	TTH20-7	7.1
TTGL7-1.0B-22L	62	22	7.0	1.0	2.5	3.3	TTH20-7	7.1
TTGL7-1.0B-30L	62	30	7.0	1.0	2.5	3.3	TTH20-7	7.1
TTGL7-1.5B-15L	62	15	7.0	1.5	2.5	3.3	TTH20-7	7.1
TTGL7-1.5B-22L	62	22	7.0	1.5	2.5	3.3	TTH20-7	7.1
TTGL7-1.5B-30L	62	30	7.0	1.5	2.5	3.3	TTH20-7	7.1
TTGL7-2.0B-15L	62	15	7.0	2.0	2.5	3.3	TTH20-7	7.1
TTGL7-2.0B-22L	62	22	7.0	2.0	2.5	3.3	TTH20-7	7.1
TTGL7-2.0B-30L	62	30	7.0	2.0	2.5	3.3	TTH20-7	7.1
TTGL8-1.0B-22L	64	22	8.0	1.0	1.7	3.8	TTH20-8	8.1
TTGL8-1.5B-22L	64	22	8.0	1.5	1.7	3.8	TTH20-8	8.1
TTGL8-2.0B-22L	64	22	8.0	2.0	2.6	3.8	TTH20-8	8.1

TTKR EINSÄTZE / TTKR BARS

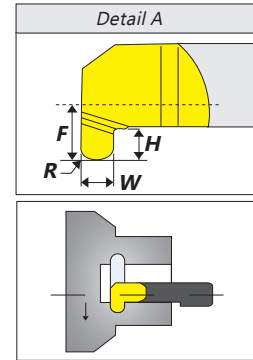
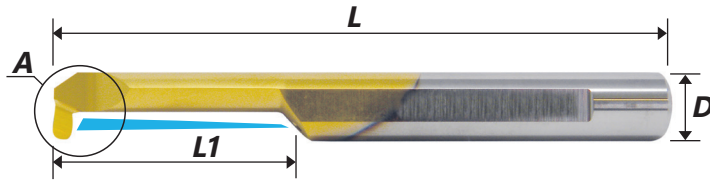

Voll Radius Einstechen | Full Radius Grooving

Artikelnummer (Item Number)	Länge (Length) in mm L	Länge (Length) in mm L1	D in mm	F	W	H	R	Halter (Holder)	Min. Bohr. (Min. Bore Dia.)
TTKR4-0.5R-10L	51	10	4.0	1.7	1.0	1.0	0.50	TTH20-4	4.1
TTKR4-0.75R-10L	51	10	4.0	1.7	1.5	1.0	0.75	TTH20-4	4.1
TTKR5-0.5R-15L	51	15	5.0	2.3	1.0	1.2	0.50	TTH20-5	5.1
TTKR5-0.75R-15L	51	15	5.0	2.3	1.5	1.2	0.75	TTH20-5	5.1
TTKR5-1.0R-15L	51	15	5.0	2.3	2.0	1.2	1.00	TTH20-5	5.1
TTKR6-0.5R-15L	51	15	6.0	2.8	1.0	1.6	0.50	TTH20-6	6.1
TTKR6-0.75R-15L	51	15	6.0	2.8	1.5	1.6	0.75	TTH20-6	6.1
TTKR6-1.0R-15L	51	15	6.0	2.8	2.0	1.6	1.00	TTH20-6	6.1
TTKR7-0.5R-22L	62	22	7.0	3.3	1.0	2.5	0.05	TTH20-7	7.1
TTKR7-0.75R-15L	62	22	7.0	3.3	1.5	2.5	0.75	TTH20-7	7.1
TTKR7-1.0R-22L	62	22	7.0	3.3	2.0	2.5	1.00	TTH20-7	7.1

TTKL EINSÄTZE / TTKL BARS

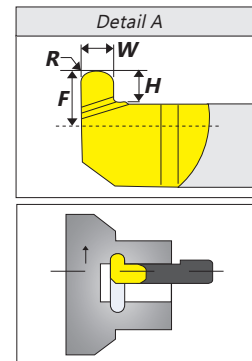
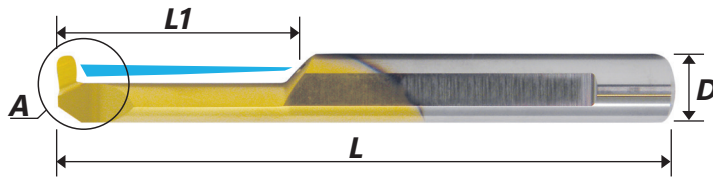

Voll Radius Einstechen | Full Radius Grooving

Artikelnummer (Item Number)	Länge (Length) in mm L	Länge (Length) in mm L1	D in mm	F	W	H	R	Halter (Holder)	Min. Bohr. (Min. Bore Dia.)
TTKL4-0.5R-10L	51	10	4.0	1.7	1.0	1.0	0.50	TTH20-4	4.1
TTKL4-0.75R-10L	51	10	4.0	1.7	1.5	1.0	0.75	TTH20-4	4.1
TTKL5-0.5R-15L	51	15	5.0	2.3	1.0	1.2	0.50	TTH20-5	5.1
TTKL5-0.75R-15L	51	15	5.0	2.3	1.5	1.2	0.75	TTH20-5	5.1
TTKL5-1.0R-15L	51	15	5.0	2.3	2.0	1.2	1.00	TTH20-5	5.1
TTKL6-0.5R-15L	51	15	6.0	2.8	1.0	1.6	0.50	TTH20-6	6.1
TTKL6-0.75R-15L	51	15	6.0	2.8	1.5	1.6	0.75	TTH20-6	6.1
TTKL6-1.0R-15L	51	15	6.0	2.8	2.0	1.6	1.00	TTH20-6	6.1
TTKL7-0.5R-22L	62	22	7.0	3.3	1.0	2.5	0.05	TTH20-7	7.1
TTKL7-0.75R-15L	62	22	7.0	3.3	1.5	2.5	0.75	TTH20-7	7.1
TTKL7-1.0R-22L	62	22	7.0	3.3	2.5	2.0	1.00	TTH20-7	7.1

TTFR EINSÄTZE / TTFR BARS

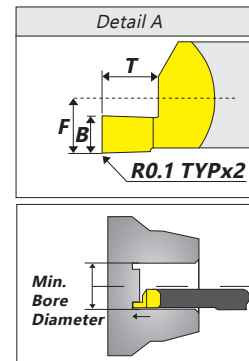
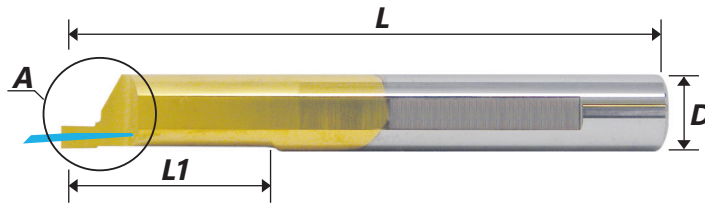

Axial Einstechen | Face Grooving

Artikelnummer (Item Number)	Länge (Length) in mm L	Länge (Length) in mm L1	D in mm	F	B	T	Halter (Holder)	Min. Bohr. (Min. Bore Dia.)
TTFR4-0.75B-15L	51	15	4.0	1.95	0.75	1.2	TTH20-4	5.0
TTFR4-1.0B-15L	51	15	4.0	1.95	1.0	1.5	TTH20-4	5.0
TTFR4-1.5B-15L	51	15	4.0	1.95	1.5	2.8	TTH20-4	5.0
TTFR5-0.75B-22L	51	22	5.0	2.45	0.75	1.2	TTH20-5	6.0
TTFR5-1.0B-22L	51	22	5.0	2.45	1.0	1.5	TTH20-5	6.0
TTFR5-1.5B-22L	51	22	5.0	2.45	1.5	2.5	TTH20-5	6.0
TTFR5-2.0B-22L	51	22	5.0	2.45	2.0	3.8	TTH20-5	6.0
TTFR6-1.0B-22L	51	22	6.0	2.95	1.0	1.5	TTH20-6	8.0
TTFR6-1.5B-22L	51	22	6.0	2.95	1.5	2.5	TTH20-6	8.0
TTFR6-2.0B-22L	51	22	6.0	2.95	2.0	3.0	TTH20-6	8.0
TTFR6-2.5B-22L	51	22	6.0	2.95	2.5	4.8	TTH20-6	8.0
TTFR6-3.0B-30L	58	30	6.0	2.95	3.0	6.0	TTH20-6	8.0
TTFR8-2.5B-22L	64	22	8.0	3.95	2.5	3.5	TTH20-8	10.0

TTFL EINSÄTZE | TTFL BARS

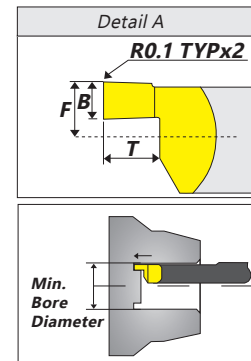
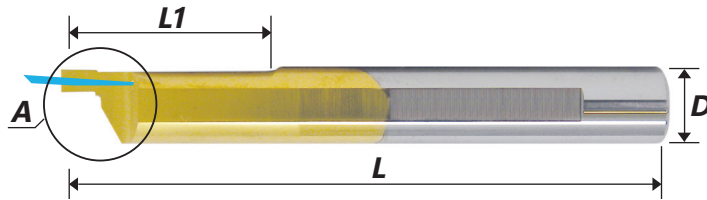

Axial Einstechen | Face Grooving

Artikelnummer (Item Number)	Länge (Length) in mm L	Länge (Length) in mm L1	D in mm	F	B	T	Halter (Holder)	Min. Bohr. (Min. Bore Dia.)
TTFL4-0.75B-15L	51	15	4.0	1.95	0.75	1.2	TTH20-4	5.0
TTFL4-1.0B-15L	51	15	4.0	1.95	1.0	1.5	TTH20-4	5.0
TTFL4-1.5B-15L	51	15	4.0	1.95	1.5	2.8	TTH20-4	5.0
TTFL5-0.75B-22L	51	22	5.0	2.45	0.75	1.2	TTH20-5	6.0
TTFL5-1.0B-22L	51	22	5.0	2.45	1.0	1.5	TTH20-5	6.0
TTFL5-1.5B-22L	51	22	5.0	2.45	1.5	2.5	TTH20-5	6.0
TTFL5-2.0B-22L	51	22	5.0	2.45	2.0	3.8	TTH20-5	6.0
TTFL6-1.0B-22L	51	22	6.0	2.95	1.0	1.5	TTH20-6	8.0
TTFL6-1.5B-22L	51	22	6.0	2.95	1.5	2.5	TTH20-6	8.0
TTFL6-2.0B-22L	51	22	6.0	2.95	2.0	3.0	TTH20-6	8.0
TTFL6-2.5B-22L	51	22	6.0	2.95	2.5	4.8	TTH20-6	8.0
TTFL6-3.0B-30L	58	30	6.0	2.95	3.0	6.0	TTH20-6	8.0
TTFL8-2.5B-22L	64	22	8.0	3.95	2.5	3.5	TTH20-8	10.0

TTUR EINSÄTZE / TTUR BARS

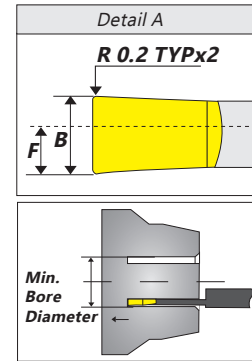
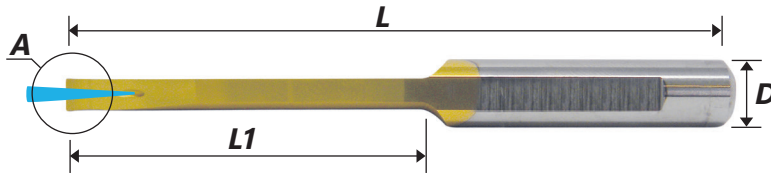

Axial Stechen - mit 2 Kühlkanälen | Deep Face Grooving - with 2 coolant bores

Artikelnummer (Item Number)	Länge (Length) in mm L	Länge (Length) in mm L1	D in mm	F	B	Halter (Holder)	Min. Bohr. (Min. Bore Dia.)
TTVR6-2.0B-15L	64	15	6.0	1.7	2.0	TTH20-6	12.0
TTVR6-2.0B-22L	64	22	6.0	1.7	2.0	TTH20-6	12.0
TTVR6-2.5B-22L	64	22	6.0	2.2	2.5	TTH20-6	12.0
TTVR8-3.0B-27L	64	27	8.0	2.5	3.0	TTH20-8	15.0
TTVR8-3.0B-43L	80	43	8.0	1.6	3.0	TTH20-8	15.0
TTVR8-4.0B-43L	80	43	8.0	1.6	4.0	TTH20-8	20.0

TTUL EINSÄTZE / TTUL BARS

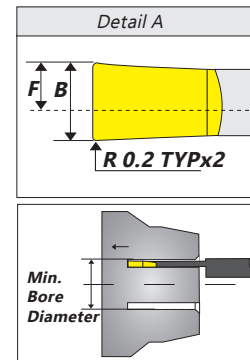
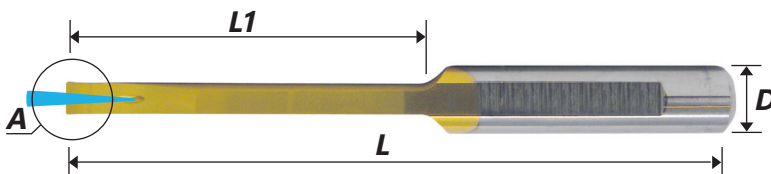

Axial Stechen - mit 2 Kühlkanälen | Deep Face Grooving - with 2 coolant bores

Artikelnummer (Item Number)	Länge (Length) in mm L	Länge (Length) in mm L1	D in mm	F	B	Halter (Holder)	Min. Bohr. (Min. Bore Dia.)
TTVL6-2.0B-15L	64	15	6.0	1.7	2.0	TTH20-6	12.0
TTVL6-2.0B-22L	64	22	6.0	1.7	2.0	TTH20-6	12.0
TTVL6-2.5B-22L	64	22	6.0	2.2	2.5	TTH20-6	12.0
TTVL8-3.0B-27L	64	27	8.0	2.5	3.0	TTH20-8	15.0
TTVL8-3.0B-43L	80	43	8.0	1.6	3.0	TTH20-8	15.0
TTVL8-4.0B-43L	80	43	8.0	1.6	4.0	TTH20-8	20.0

TTZR EINSÄTZE / TTZR BARS

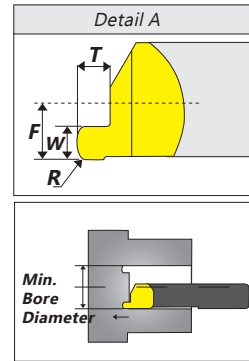
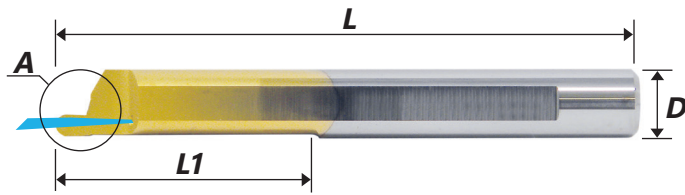

Axial Einstechen | Face Grooving

Artikelnummer (Item Number)	Länge (Length) in mm L	Länge (Length) in mm L1	D in mm	F	W	T	R	Halter (Holder)	Min. Bohr. (Min. Bore Dia.)
TTZR4-0.5R-15L	51	15	4.0	1.95	1.0	1.2	0.50	TTH20-4	5.0
TTZR4-0.75R-15L	51	15	4.0	1.95	1.5	1.5	0.75	TTH20-4	5.0
TTZR5-0.5R-22L	51	22	5.0	2.45	1.0	1.2	0.50	TTH20-5	6.0
TTZR5-0.75R-22L	51	22	5.0	2.45	1.5	1.5	0.75	TTH20-5	6.0
TTZR5-1.0R-22L	51	22	5.0	2.45	2.0	2.5	1.00	TTH20-5	6.0
TTZR6-0.5R-22L	51	22	6.0	2.95	1.0	1.2	0.50	TTH20-6	8.0
TTZR6-0.75R-22L	51	22	6.0	2.95	1.5	1.5	0.75	TTH20-6	8.0
TTZR6-1.0R-22L	51	22	6.0	2.95	2.0	2.5	1.00	TTH20-6	8.0

TTZL EINSÄTZE / TTZL BARS

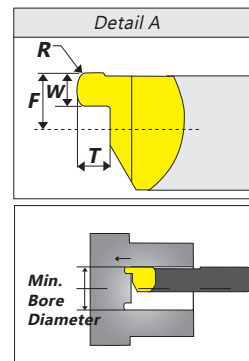
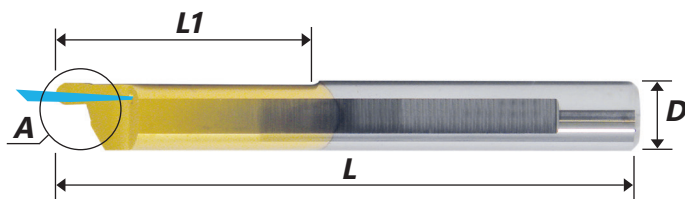

Axial Einstechen | Face Grooving

Artikelnummer (Item Number)	Länge (Length) in mm L	Länge (Length) in mm L1	D in mm	F	W	T	R	Halter (Holder)	Min. Bohr. (Min. Bore Dia.)
TTZL4-0.5R-15L	51	15	4.0	1.95	1.0	1.2	0.50	TTH20-4	5.0
TTZL4-0.75R-15L	51	15	4.0	1.95	1.5	1.5	0.75	TTH20-4	5.0
TTZL5-0.5R-22L	51	22	5.0	2.45	1.0	1.2	0.50	TTH20-5	6.0
TTZL5-0.75R-22L	51	22	5.0	2.45	1.5	1.5	0.75	TTH20-5	6.0
TTZL5-1.0R-22L	51	22	5.0	2.45	2.0	2.5	1.00	TTH20-5	6.0
TTZL6-0.5R-22L	51	22	6.0	2.95	1.0	1.2	0.50	TTH20-6	8.0
TTZL6-0.75R-22L	51	22	6.0	2.95	1.5	1.5	0.75	TTH20-6	8.0
TTZL6-1.0R-22L	51	22	6.0	2.95	2.0	2.5	1.00	TTH20-6	8.0

THREAD TURNING

PRODUKTBEZEICHNUNG | *PRODUCT DESIGNATION*

BEISPIEL | *EXAMPLE: SKS2-23S-5L*

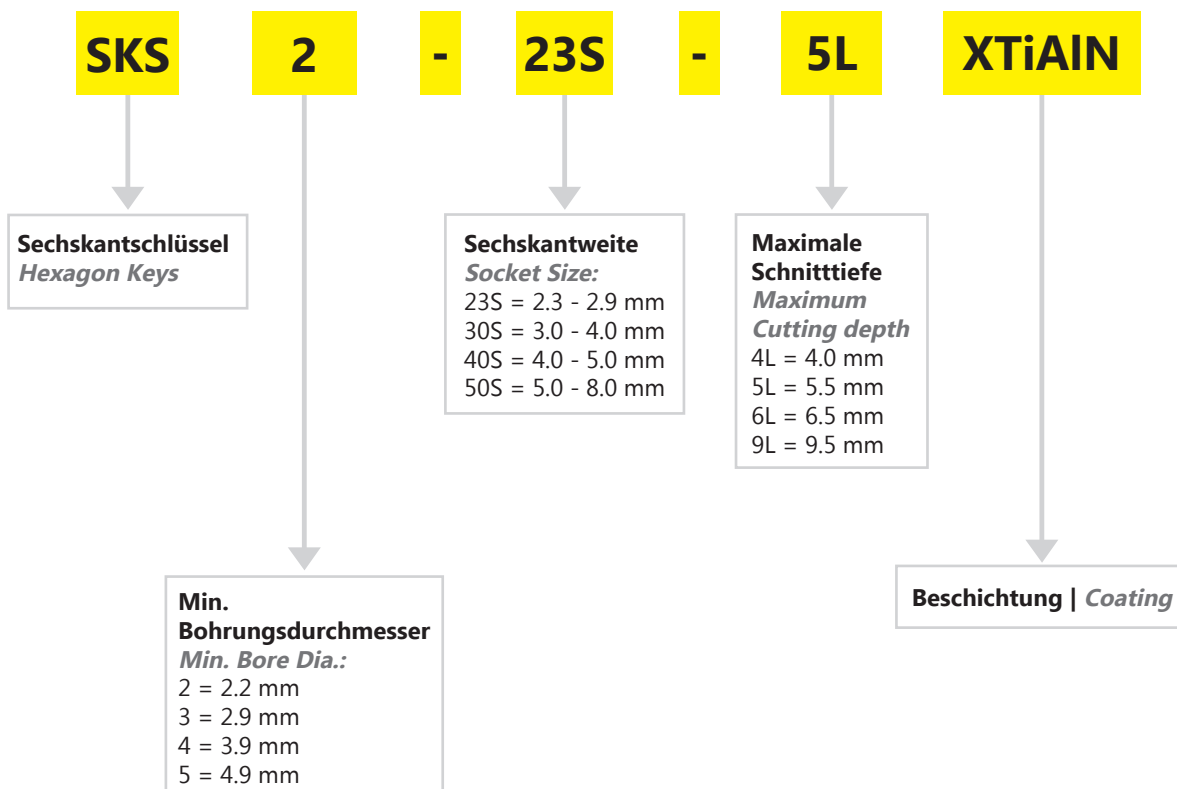

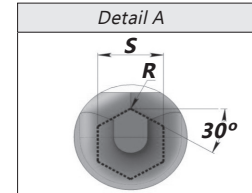
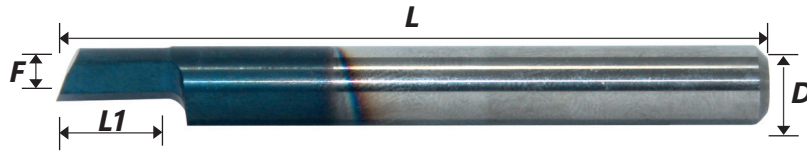
SKS

Räumwerkzeug für Sechskantschlüssel | Broaching Tools for Hexagon Keys

Artikelnummer (Item Number)	Länge (Length) in mm L	Länge (Length) in mm L1	D in mm	S	R	F	Halter (Holder)	Min. Bohr. (Min. Bore Dia.)
SKS2-23S-5L	51	4.0		2.3 - 2.9	0.05	1.35	TTH...5	2.2
SKS3-30S-5L	51	5.5	5.0	3.0 - 4.0	0.05	1.35		2.9
SKS4-40S-6L	51	6.5		4.0 - 5.0	0.10	1.35		3.9
SKS5-50S-9L	62	9.5	7.0	5.0 - 8.0	0.10	1.35	TTH...7	4.9

THREAD TURNING

PRODUKTBEZEICHNUNG | *PRODUCT DESIGNATION*

BEISPIEL | *EXAMPLE: TTH16-3S*

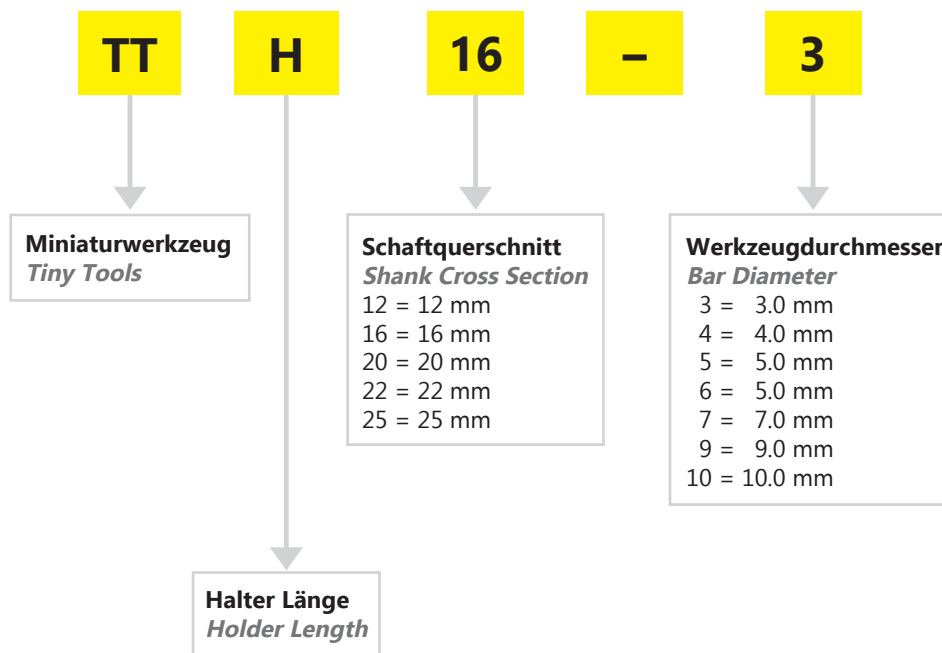

SPANNHÜLSEN / TINY TOOLS BAR HOLDERS

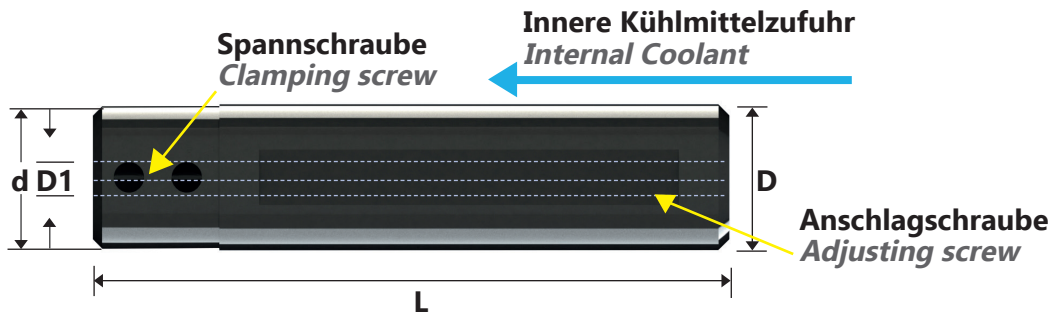

Artikelnummer (Item Number)	Länge (Length) in mm L	D1	D	d	Torx Schlüssel (Torx Key)	Spanschraube für Platte (Clamping Screw)	Anschlagschraube (Adjusting Screw)
TTH12-3	88	3.0	12	12	TX25	S24	S35
TTH16-3S	75	3.0	16	20	TX25	S25	S35S
TTH16-3	88	3.0	16	20	TX25	S25	S35
TTH20-3	88	3.0	20	20	TX25	S25	S35
TTH22-3	88	3.0	22	22	TX25	S25	S35
TTH12-4	88	4.0	12	12	TX25	S24	S35
TTH16-4S	75	4.0	16	20	TX25	S25	S35S
TTH16-4	88	4.0	16	20	TX25	S25	S35
TTH20-4	88	4.0	20	20	TX25	S25	S35
TTH22-4	88	4.0	22	22	TX25	S25	S35
TTH12-5	88	5.0	12	12	TX25	S24	S35
TTH16-5S	75	5.0	16	20	TX25	S25	S35S
TTH16-5	88	5.0	16	20	TX25	S25	S35
TTH20-5	88	5.0	20	20	TX25	S25	S35
TTH22-5	75	5.0	22	22	TX25	S25	S35
TTH16-6S	75	6.0	16	20	TX25	S25	S35S
TTH16-6	88	6.0	16	20	TX25	S25	S35
TTH20-6	88	6.0	20	20	TX25	S25	S35
TTH22-6	88	6.0	22	22	TX25	S25	S35
TTH16-7	88	7.0	16	20	TX25	S25	S35
TTH20-7	88	7.0	20	20	TX25	S25	S35
TTH22-7	88	7.0	22	22	TX25	S25	S35
TTH16-8	88	8.0	16	20	TX25	S25	S35
TTH20-8	88	8.0	20	20	TX25	S25	S35
TTH22-8	88	8.0	22	22	TX25	S25	S35
TTH16-10	88	10.0	16	20	TX25	S25	S35
TTH20-10	88	10.0	20	20	TX25	S25	S35
TTH22-10	88	10.0	22	22	TX25	S25	S35

TECHNISCHER TEIL (TECHNICAL SECTION)

Hartmetall - Qualität (Carbide Grades):

TiAlN (K10 - K20)

Feinstkorn Hartmetall mit einer PVD-Mehrlagenbeschichtung. Sehr hohe Temperaturbeständigkeit auch bei Trockenbearbeitung. Speziell für schwer zerspanbare Materialien wie Inconel, nickelbasis Legierungen, Titan und gehärtete Stoffe bis 62 HRc geeignet.

(Sub-micron grade with advanced PVD-triple coating. Very high heat resistance also by dry machining. Especially for difficult machining materials such as Inconel, Nickel based alloys, Titanium and hardened materials up to 62 HRc.)

SCHNITTGESCHWINDIGKEIT FÜR MINI-WERKZEUGE (CUTTING SPEED FOR TINY TOOLS)

ISO	Materialien (Material)		Beschaffenheit (Condition)	Schnittgeschwindigkeit (Cutting Speed) m/min	
				TiAlN	
P	Unlegierter Stahl und Stahlguss, Automatenstahl <i>Non-Alloy Steel and Cast Steel, Free machining Steel</i>	< 0.25%C	Gehärtet <i>Annealed</i>	30 - 80	
		≥ 0.25%C	Gehärtet <i>Annealed</i>		
		< 0.55%C	Geglüht und gepresst <i>Quenched & Tempered</i>		
		≥ 0.55%C	Gehärtet <i>Annealed</i>		
	Niedrig legierter Stahl und Stahlguss (weniger als 5% legierte Stoffe) <i>Low Alloy Steel and Cast Steel (less than 5% alloying elements)</i>		Gehärtet <i>Annealed</i>	25 - 50	
			Geglüht und gepresst <i>Quenched & Tempered</i>		
Hochlegierter Stahl, Stahlguss und Werkzeugstahl <i>High Alloy Steel, Cast Steel and Tool Steel</i>		Gehärtet <i>Annealed</i>	25 - 50		
		Geglüht und gepresst <i>Quenched & Tempered</i>			
M	Edelstahl und Edelstahlguss <i>Stainless Steel and Cast stainless Steel</i>		Ferritisch / Martensitisch <i>Ferritic / Martensitic</i>	30 - 60	
			Martensitisch <i>Martensitic</i>		
			Austinitisch <i>Austenitic</i>		
K	Kugelgraphitgusseisen (GGG) <i>Cast Iron Nodular (GGG)</i>		Ferritisch / Perlitisch <i>Ferritic / Pearlitic</i>	30 - 80	
			Pearlitisch <i>Pearlitic</i>		
	Grauguss (GG) <i>Grey Cast Iron (GG)</i>		Ferritisch <i>Ferritic</i>	30 - 80	
			Pearlitisch <i>Pearlitic</i>		
	Temperguss <i>Malleable Cast Iron</i>		Ferritisch <i>Ferritic</i>	20 - 50	
Pearlitisch <i>Pearlitic</i>					
N	Aluminiumknetlegierung <i>Aluminium-Wrought Alloy</i>		Ungealtert <i>Not hardened</i>	60 - 120	
			Gealtert <i>Precipitation Hardened</i>		
	Aluminiumguss, vergütet <i>Aluminum-Cast, Alloyed</i>	<= 12% Si	Ungealtert <i>Not hardened</i>	50 - 90	
			Gealtert <i>Precipitation Hardened</i>		
		> 12% Si	Hochwärmefest <i>High Temperature</i>		
	Kupferlegierung <i>Copper Alloys</i>	> 1% Pb		Automatenkupferlegierung <i>Free Cutting</i>	30 - 70
				Messing <i>Brass</i>	
Elektrolytkupfer <i>Electrolytic Copper</i>					
Nichtmetallische Werkstoffe <i>Non-Metals Materials</i>		Thermoplast, Faserverbundwerkstoff <i>Thermoplastics, Fiber Plastics</i>			
		Hartgummi <i>Hard Rubber</i>			
S	Hochtemperaturlegierungen, Superlegierung <i>High Temp. Alloys, Super Alloys</i>	Fe basierend <i>Fe based</i>	Gehärtet <i>Annealed</i>	15 - 40	
			Gealtert <i>Cured</i>		
		Ni oder Co basierend <i>Ni or Co based</i>	Gehärtet <i>Annealed</i>		
			Gealtert <i>Cured</i>		
	Titanlegierung <i>Titanium Alloys</i>		Guss <i>Cast</i>		
Titanlegierung <i>Titanium Alloys</i>		Alpha+Beta Legierung gealtert <i>Alpha + Beta Alloys Cured</i>	10 - 30		
H	Gehärteter Stahl <i>Hardened Steel</i>		Gehärtet <i>Hardened 45-50 HRc</i>	15 - 40	
			Gehärtet <i>Hardened 51-55 HRc</i>		
			Gehärtet <i>Hardened 56-62 HRc</i>		
	Schalenhartguss <i>Chilled Cast Iron</i>		Guss <i>Cast</i>	10 - 30	
Gusseisen <i>Cast Iron</i>		Gehärtet <i>Hardened</i>	10 - 20		

DURCHGÄNGE (NUMBER OF PASSES)

Steigung (Pitch):	mm Gänge/Zoll (TPI):	0.5 48	0.7 36	0.8 32	1.0 24	1.25 20	1.5 16	2-5 14-5
Schnittzahl (Number of Passes):		6-12	7-14	7-16	8-18	8-20	10-22	20-38

SKS RÄUMWERKZEUG FÜR SECHSKANTSCHLÜSSEL (SKS BROACHING TOOLS FOR HEXAGON KEYS)

Das Räumwerkzeug wurde entwickelt, um einen Innensechskant ins Sacklöcher und Durchgangsbohrungen auf CNC-Maschine herzustellen. Nur der Deutsche Satz muss abgeändert werden. *(The SKS broaching system have been developed to machine internal keyways inside blind or through holes, using CNC machines.)*

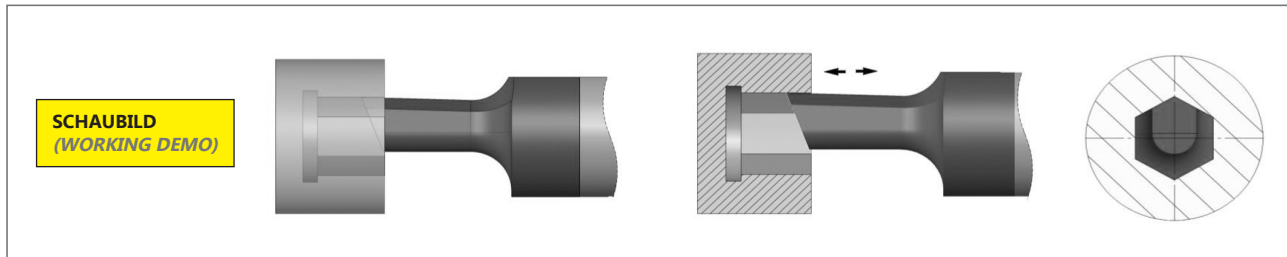

- Mit Standard TTH-Haltern zu verwenden.
(To use with standard TTH Bar Holders)
- Der Halter kann direkt in den Revolver oder die Spindel gespannt werden.
(The holder can be located directly in the turret or the machine spindle.)
- Halter mit rückseitiger Verschraubung für optimale Spannung.
(Holder with rear clamping screw for full support during operation.)
- Ausschließlich in TiAlN-Beschichtung verfügbar.
(Available in TiAlN Grade only.)

6 GEWINDEWIRBELWERKZEUGE

THREAD WHIRLING

FÜR LANGE, PERFEKTE GEWINDE AUF LANGDREHAUTOMATEN (FOR PERFECT LONG THREADS ON CNC SWISS-TYPE LATHES)

Gewindewirbeln ist eine schnelle und akkurate Art und Weise um lange Gewinde mit kleinen Durchmessern in exotischen Materialien wie Titan, Edelstahl und Inconel herzustellen.

Der Gewindewirbelring mit Wendepplatten kann eine Vielzahl von medizinischen Teilen herstellen wie z.B. Zahnimplantate und Knochenschrauben, Automobilteile sowie kleine Halbleiterbauteile.

Um das Gewinde zu schneiden dreht sich der Gewindewirbelkopf mit Wendepplatten mit hoher Geschwindigkeit um ein langsam drehendes Werkstück. Durch die Vorschubbewegung (entsprechend der Steigung) wird das Gewinde auf die gewünschte Länge geschnitten.

Thread Whirling is a fast and accurate way to thread long, small diameter parts made of exotic materials such as titanium, stainless steel and Inconel.

Whirling inserts and holders can produce a wide range of medical parts such as dental implants and bone screws, automotive parts and small semiconductor parts.

Cutting is the result of the whirling unit rotating eccentrically at high speed about the slowly rotating workpiece. The desired thread length is achieved through rotational motion of the workpiece and longitudinal motion of the whirling unit correspondig to the required pitch.

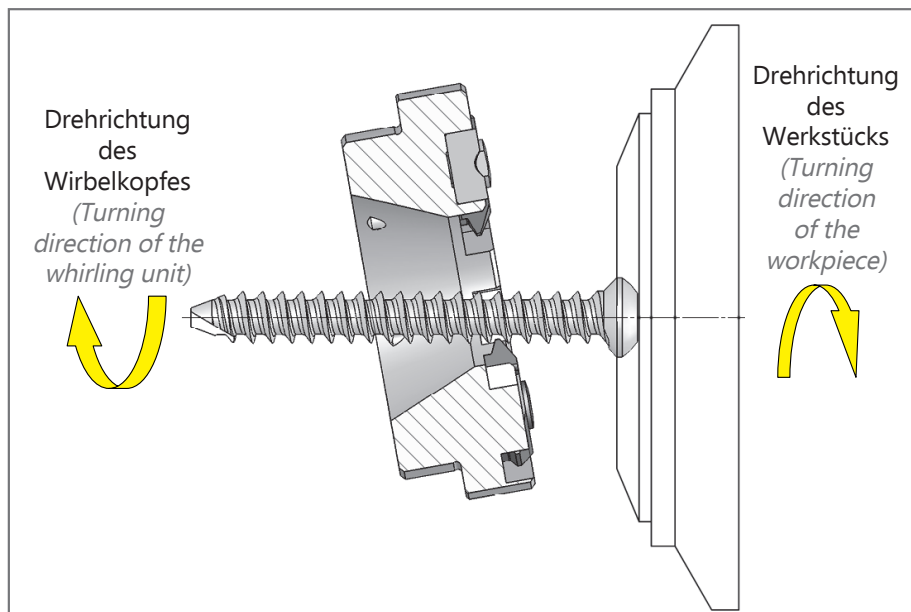

Hartmetallsorte (Carbide Grade):

TiAlN-PVD TiAlN beschichtetes Feinstkornhartmetall für rostfreie Stähle, exotische und medizinische Materialien.

TiAlN-PVD TiAlN coated submicrograin for stainless steel, exotic and medical materials.

VORTEILE GEWINDEWIRBELN (*THREAD WHIRLING ADVANTAGES*)

Gewindewirbeln bietet mehrere Vorteile gegenüber einem Einzahn-Gewindeschneidwerkzeug
(*Thread Whirling offers several advantages over single point threading*):

Erhöhte Produktivität (*Increased Productivity*):

Gewindewirbeln wird in einem einzigen Durchgang durchgeführt, dadurch wird die Bearbeitungszeit minimiert. Mehrere Durchgänge, wie bei einem Einzahn-Gewindeschneidwerkzeug, sind nicht mehr nötig. Gewindewirbeln ermöglicht das Arbeiten mit hohen Vorschubgeschwindigkeiten. Es werden kürzere Zykluszeiten erzielt.

Thread Whirling is performed in a single pass, resulting in a shorter machining time. This eliminates multiple passes required for a single point threading. Thread whirling allows working at high feed rates and consequently short cycle times.

Sehr hohe Oberflächengüte und genaue Geometrie (*Very high surface quality and accurate geometry*):

Der Einsatz von bis zu 8 Schneidkanten, höhere Rundlaufgenauigkeit, spezielle Schneidengeometrie und optimaler Spanabfuhr ermöglichen eine hochwertige Oberfläche ohne Gratbildung.

The use of up to 8 cutting edges, higher concentricity, special cutting edge geometry and optimal chip evacuation, enable top quality surfaces to be produced without burr.

Hohe Standzeiten (*Long tool life*):

Wendepplatten für das Gewindewirbeln haben stabilere Schneidkanten als Einzahn-Gewindeschneidwerkzeuge, da der Seitenabstand der Schneidkante durch das Drehen der Wirbelspindel erreicht wird und nicht durch Entlastung des Materials unter der Schneidkante.

Whirling inserts have a stronger cutting edge than single point tools, because cutter side clearance is achieved by rotating the whirling spindle and not by relieving material under the cutting edge.

Schnellere Rüstzeit (*Faster Setup*):

Gewindewirbeln eliminiert spezielle Haltevorrichtungen und teure Startentwicklungskosten.

Thread whirling eliminates special support devices and expensive startup development costs.

Ausgleich von großen Steigungswinkeln (*Compensation of large helix angles*):

Große Steigungswinkel können durch das Einstellen des Wirbelkopfes ausgeglichen werden.

Large helix angles can be compensated by adjustment of the whirling unit.

- ein Wirbelkopf kann für eine Vielzahl von Anwendungen benutzt werden
- alle Werkzeughalter sind Standard Lagerware
- für jede Anwendung werden Sonderplatten hergestellt
- die Wirbelköpfe sind passend zu den verschiedenen Maschinenherstellern und Typen erhältlich
- passende Aufnahmen für die Wirbelköpfe sind ebenfalls lagerhaltig
- *one toolholder can be used for various applications*
- *all toolholders are standard stock items*
- *for each application, there're special inserts*
- *the toolholders are designed according to different machine types and manufacturers*
- *special adaptors for machine heads are available as stock items*



THREAD MILLING



7

GEWINDEFRÄSPLATTEN

THREAD MILLING INSERTS

THREAD MILLING

PRODUKT BEZEICHNUNG | PRODUCT DESIGNATION

BEISPIEL | EXAMPLE: 30EX12UN TiAlN

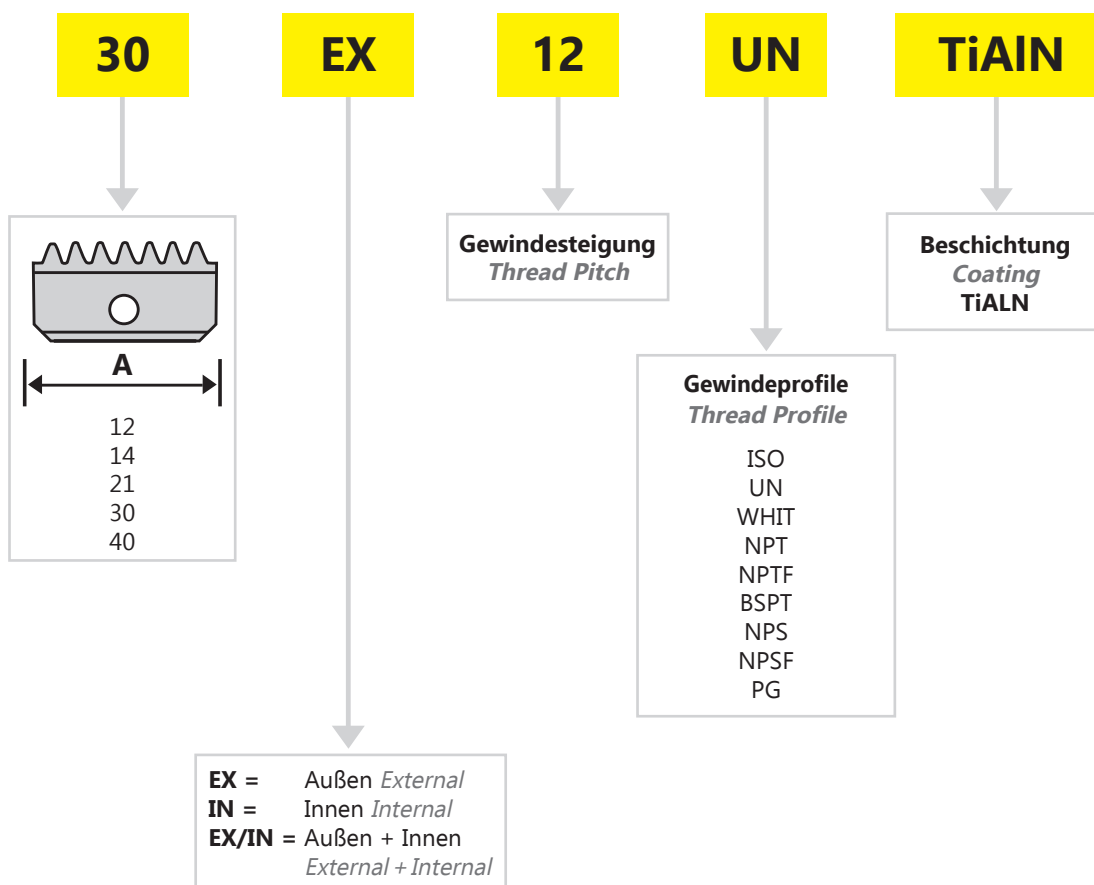

ISO

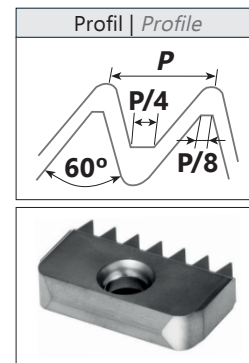
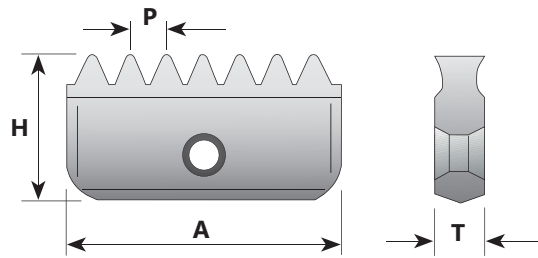

Steigung (Pitch) P	A=12 mm	A=14 mm	A=21 mm	A=30 mm	A=40 mm
0.50 EXT					
0.50 INT	*12IN0.5ISO	14IN0.5ISO			
0.75 EXT		14EX0.75ISO			
0.75 INT	*12IN0.75ISO	14IN0.75ISO			
1.00 EXT		14EX1.0ISO	21EX1.0ISO		
1.00 INT	*12IN1.0ISO	14IN1.0ISO	21IN1.0ISO		
1.25 EXT		14EX1.25ISO			
1.25 INT	*12IN1.25ISO	14IN1.25ISO			
1.50 EXT		14EX1.5ISO	21EX1.5ISO	30EX1.5ISO	40EX1.5ISO
1.50 INT	*12IN1.5ISO	14IN1.5ISO	21IN1.5ISO	30IN1.5ISO	40IN1.5ISO
1.75 EXT		14EX1.75ISO			
1.75 INT		14IN1.75ISO	21IN1.75ISO		
2.00 EXT		14EX2.0ISO	21EX2.0ISO	30EX2.0ISO	40EX2.0ISO
2.00 INT		14IN2.0ISO	21IN2.0ISO	30IN2.0ISO	40IN2.0ISO
2.50 EXT		14EX2.5ISO	21EX2.5ISO		
2.50 INT		14IN2.5ISO	21IN2.5ISO		
3.00 EXT			21EX3.0ISO	30EX3.0ISO	40EX3.0ISO
3.00 INT			21IN3.0ISO	30IN3.0ISO	40IN3.0ISO
3.50 EXT				30EX3.5ISO	
3.50 INT			21IN3.5ISO	30IN3.5ISO	40IN3.5ISO
4.00 EXT				30EX4.0ISO	40EX4.0ISO
4.00 INT				30IN4.0ISO	40IN4.0ISO
4.50 EXT					
4.50 INT				30IN4.5ISO	40IN4.5ISO
5.00 EXT					40EX5.0ISO
5.00 INT				30IN5.0ISO	40IN5.0ISO
5.50 EXT					
5.50 INT				30IN5.5ISO	40IN5.5ISO
6.00 EXT					40EX6.0ISO
6.00 INT					40IN6.0ISO
H	6.3	7.5	12	16	20
T	2.9	3.1	4.7	5.5	6.3

* eine Schneidkante | one cutting edge

UN UNC, UNF, UNEF, UNS

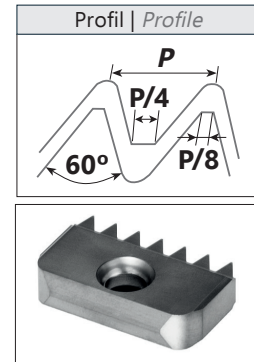
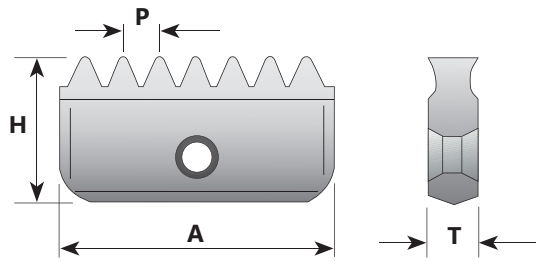

Gänge/Zoll (Pitch TPI) P	A=12 mm	A=14 mm	A=21 mm	A=30 mm	A=40 mm
32 EXT		14EX32UN			
32 INT	*12IN32UN	14IN32UN			
28 EXT		14EX28UN			
28 INT	*12IN28UN	14IN28UN			
27 EXT					
27 INT		14IN27UN			
24 EXT		14EX24UN	21EX24UN		
24 INT	*12IN24UN	14IN24UN	21IN24UN		
20 EXT		14EX20UN	21EX20UN	30EX20UN	
20 INT	*12IN20UN	14IN20UN	21IN20UN	30IN20UN	
18 EXT		14EX18UN	21EX18UN	30EX18UN	
18 INT	*12IN18UN	14IN18UN	21IN18UN	30IN18UN	
16 EXT		14EX16UN	21EX16UN	30EX16UN	40EX16UN
16 INT	*12IN16UN	14IN16UN	21IN16UN	30IN16UN	40IN16UN
14 EXT		14EX14UN	21EX14UN	30EX14UN	40EX14UN
14 INT		14IN14UN	21IN14UN	30IN14UN	40IN14UN
12 EXT		14EX12UN	21EX12UN	30EX12UN	40EX12UN
12 INT		14IN12UN	21IN12UN	30IN12UN	40IN12UN
11 EXT		14EX11UN			
11 INT		14IN11UN			
10 EXT		14EX10UN	21EX10UN	30EX10UN	40EX10UN
10 INT		14IN10UN	21IN10UN	30IN10UN	40IN10UN
9 EXT					
9 INT		*14IN9UN			
8 EXT				30EX8UN	40EX8UN
8 INT			21IN8UN	30IN8UN	40IN8UN
7 EXT					
7 INT			21IN7UN		
6 EXT				30EX6UN	40EX6UN
6 INT				30IN6UN	40IN6UN
5 EXT					
5 INT				30IN5UN	
4.5 EXT					
4.5 INT					40IN4.5UN
4 EXT					
4 INT					40IN4UN
H	6.3	7.5	12	16	20
T	2.9	3.1	4.7	5.5	6.3

* eine Schneidkante | one cutting edge

WHIT BSW, BSF, BSP

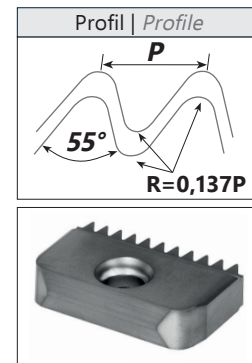
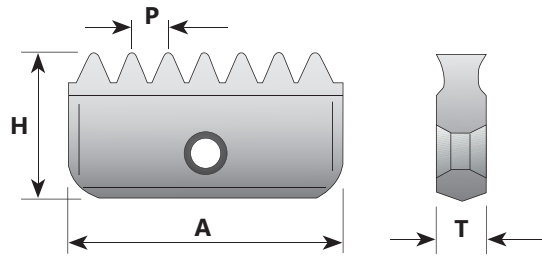

gleiche Platte für Innen- und Außengewinde | same insert for external and internal thread

Gänge/Zoll (Pitch TPI) P	A=12 mm	A=14 mm	A=21 mm	A=30 mm	A=40 mm
24		14EX/IN24W			
20		14EX/IN20W	21EX/IN20W		
19	*12EX/IN19W	14EX/IN19W	21EX/IN19W		
16		14EX/IN16W	21EX/IN16W	30EX/IN16W	
14		14EX/IN14W	21EX/IN14W	30EX/IN14W	
11		14EX/IN11W	21EX/IN11W	30EX/IN11W	40EX/IN11W
8					40EX/IN8W
H	6.3	7.5	12	16	20
T	2.9	3.1	4.7	5.5	6.3

* eine Schneidkante | one cutting edge

BSPT

Fräsplatten haben nur eine Schneidkante und können für Innen- und Außengewinde benutzt werden
(Conical pipe thread milling inserts are one sided and may be used for both external and internal threading)

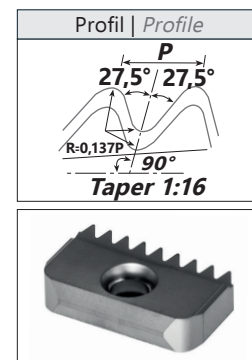
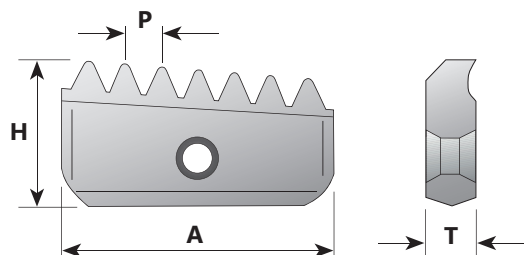

Fräsplatten für konische Gewinde | Thread milling inserts for conical pipes

Gänge/Zoll (Pitch TPI) P	A=12 mm	A=14 mm	A=21 mm	A=30 mm	A=40 mm
19	12EX/IN19BSPT	14EX/IN19BSPT			
14		14EX/IN14BSPT	21EX/IN14BSPT		
11			21EX/IN11BSPT	30EX/IN11BSPT	40EX/IN11BSPT
H	6.3	7.5	12	16	20
T	2.9	3.1	4.7	5.5	6.3

Für Vorbereitung siehe konische VHM-Schaftfräser siehe Seite 168 | For preparation use tapered solid carbide milling cutters see page 168

NPT

Fräsplatten haben nur eine Schneidkante und können für Innen- und Außengewinde benutzt werden

Conical pipe thread milling inserts are one sided and may be used for both external and internal threading)

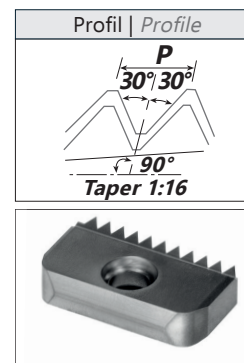
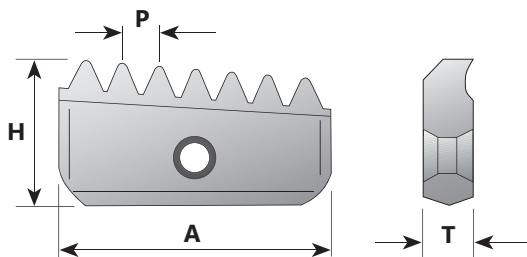

Fräsplatten für konische Gewinde | Thread milling inserts for conical pipes

Gänge/Zoll (Pitch TPI) P	A=12 mm	A=14 mm	A=21 mm	A=30 mm	A=40 mm
18	IN18NPT	14EX/IN18NPT			
14		14EX/IN14NPT	21EX/IN14NPT		
11.5			21EX/IN11.5NPT	30EX/IN11.5NPT	40EX/IN11.5NPT
8				30EX/IN8NPT	40EX/IN8NPT
H	6.3	7.5	12	16	20
T	2.9	3.1	4.7	5.5	6.3

NPTF

Fräsplatten haben nur eine Schneidkante und können für Innen- und Außengewinde benutzt werden

Conical pipe are one sided and may be used for both external and internal threading)

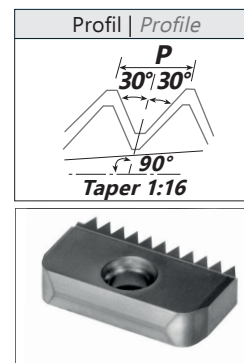
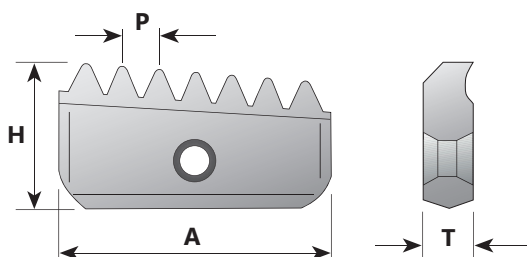

Fräsplatten für konische Gewinde | Thread milling inserts for conical pipes

Gänge/Zoll (Pitch TPI) P	A=12 mm	A=14 mm	A=21 mm	A=30 mm	A=40 mm
18	12EX/IN18NPTF	14EX/IN18NPTF			
14		14EX/IN14NPTF	21EX/IN14NPTF		
11.5			21EX/IN11.5NPTF	30EX/IN11.5NPTF	40EX/IN11.5NPTF
8				30EX/IN8NPTF	40EX/IN8NPTF
H	6.3	7.5	12	16	20
T	2.9	3.1	4.7	5.5	6.3

Für Vorbereitung siehe konische VHM-Schaftfräser siehe Seite 168 | For preparation use tapered solid carbide milling cutters see page 168

NPS

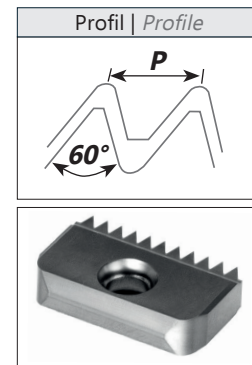
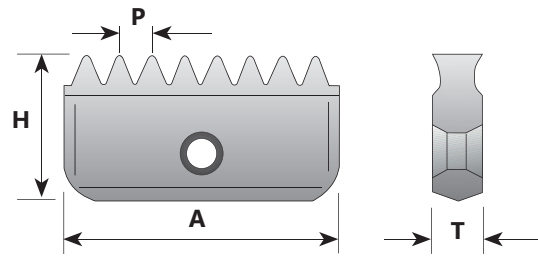

gleiche Platte für Innen- und Außengewinde | same insert for external and internal thread

Gänge/Zoll (Pitch TPI) P	A=12 mm	A=14 mm	A=21 mm	A=30 mm	A=40 mm
18	*12EX/IN18NPS	14EX/IN18NPS			
14		14EX/IN14NPS	21EX/IN14NPS		
11.5			21EX/IN11.5NPS	30EX/IN11.5NPS	40EX/IN11.5NPS
8				30EX/IN8NPS	40EX/IN8NPS
H	6.3	7.5	12	16	20
T	2.9	3.1	4.7	5.5	6.3

* eine Schneidkante | one cutting edge

NPSF

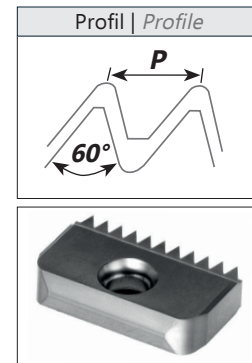
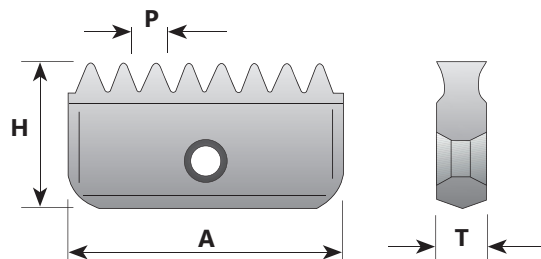

gleiche Platte für Innen- und Außengewinde | same insert for external and internal thread

Gänge/Zoll (Pitch TPI) P	A=12 mm	A=14 mm	A=21 mm	A=30 mm	A=40 mm
18	*12EX/IN18NPSF	14EX/IN18NPSF			
14		14EX/IN14NPSF	21EX/IN14NPSF		
11.5			21EX/IN11.5NPSF	30EX/IN11.5NPSF	40EX/IN11.5NPSF
8				30EX/IN8NPSF	40EX/IN8NPSF
H	6.3	7.5	12	16	20
T	2.9	3.1	4.7	5.5	6.3

* eine Schneidkante | one cutting edge

PG DIN 40430

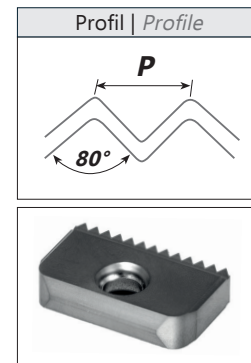
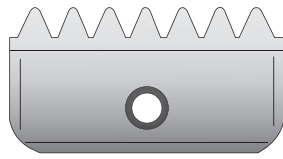

gleiche Platte für Innen- und Außengewinde | same insert for external and internal thread

Gänge/Zoll (Pitch TPI) P	A=14 mm	A=21 mm	A=30 mm
18	14EX/IN18 PG (PG 9, 11, 13.5, 16)	21EX/IN18 PG (PG 16)	
16		21EX/IN16 PG (PG 21, 29, 36, 42, 48)	30EX/IN16 PG (PG 36, 42, 48)
H	7.5	12	16
T	3.1	4.7	5.6

UNJ

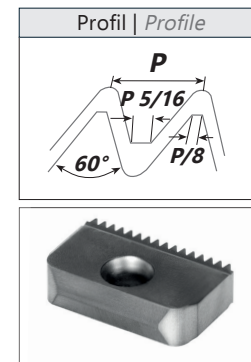
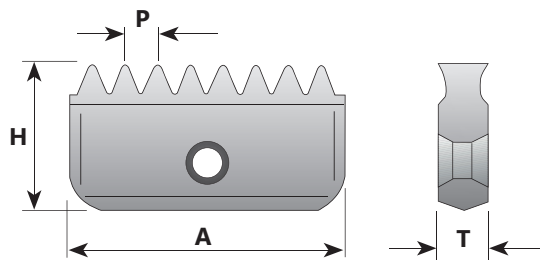

gleiche Platte für Innen- und Außengewinde | same insert for external and internal thread

Gänge/Zoll (Pitch TPI) P	A=14 mm	A=21 mm
24	14EX24UNJ	21EX24UNJ
20	14EX20UNJ	21EX20UNJ
18	14EX18UNJ	21EX18UNJ
16	14EX16UNJ	21EX16UNJ
14	14EX14UNJ	21EX14UNJ
12	14EX12UNJ	21EX12UNJ
H	7.5	12
T	3.1	4.7

Für das UNJ Innengewinde werden häufig UN-Platten als Teilprofilwerkzeug verwendet
For internal UNJ threads it is common to use UN inserts as partial profile tool

AMERICAN BUTTRESS

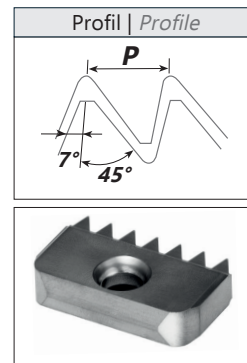
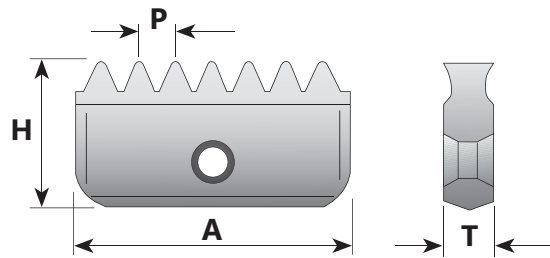

gleiche Platte für Innen- und Außengewinde | same insert for external and internal thread

Gänge/Zoll (Pitch TPI) P	A=21 mm	A=30 mm	A=40 mm
16	21EX/IN16ABUT	30EX/IN16ABUT	
12	21EX/IN12ABUT	30EX/IN12ABUT	
10	21EX/IN10ABUT	30EX/IN10ABUT	
8	21EX/IN8ABUT	30EX/IN8ABUT	
6		30EX/IN6ABUT	
4		30EX/IN4ABUT*	40EX/IN4ABUT
H	12	16	20
T	4.7	5.6	6.3

Fräsplatten für ABUT haben nur eine Schneidkante | *ABUT thread milling inserts are one-sided*
 *Ausschließlich mit Mehrzahn-Walzenfräser zu verwenden | *Inserts to be used only on Multi-Insert toolholders*

ACME

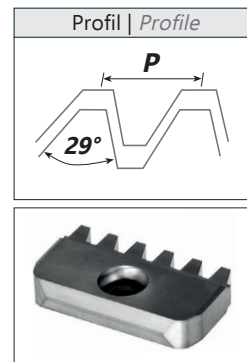
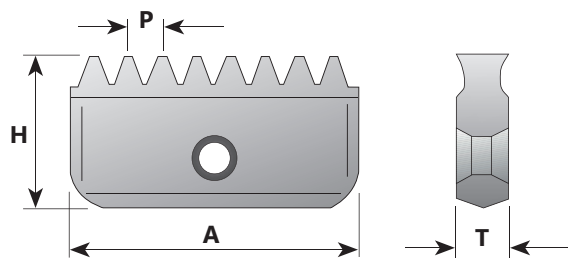

gleiche Platte für Innen- und Außengewinde | same insert for external and internal thread

Gänge/Zoll (Pitch TPI) P	A=21 mm	A=30 mm	A=40 mm
12	21IN12ACME	30IN12ACME	
10	21IN10ACME	30IN10ACME	
8	21IN8ACME	30IN8ACME	
6		30IN6ACME	
5		30IN5ACME	
4		30IN4ACME*	40IN4ACME
3.5			40IN3.5ACME
3			40IN3ACME*
H	12	16	20
T	4.7	5.6	6.3

* eine Schneidkante | *one cutting edge*



8

GEWINDEFÄSHALTER

THREAD MILLING TOOLHOLDERS

THREAD MILLING

PRODUKT BEZEICHNUNG | PRODUCT DESIGNATION

BEISPIEL | EXAMPLE: TMH21-21K-C

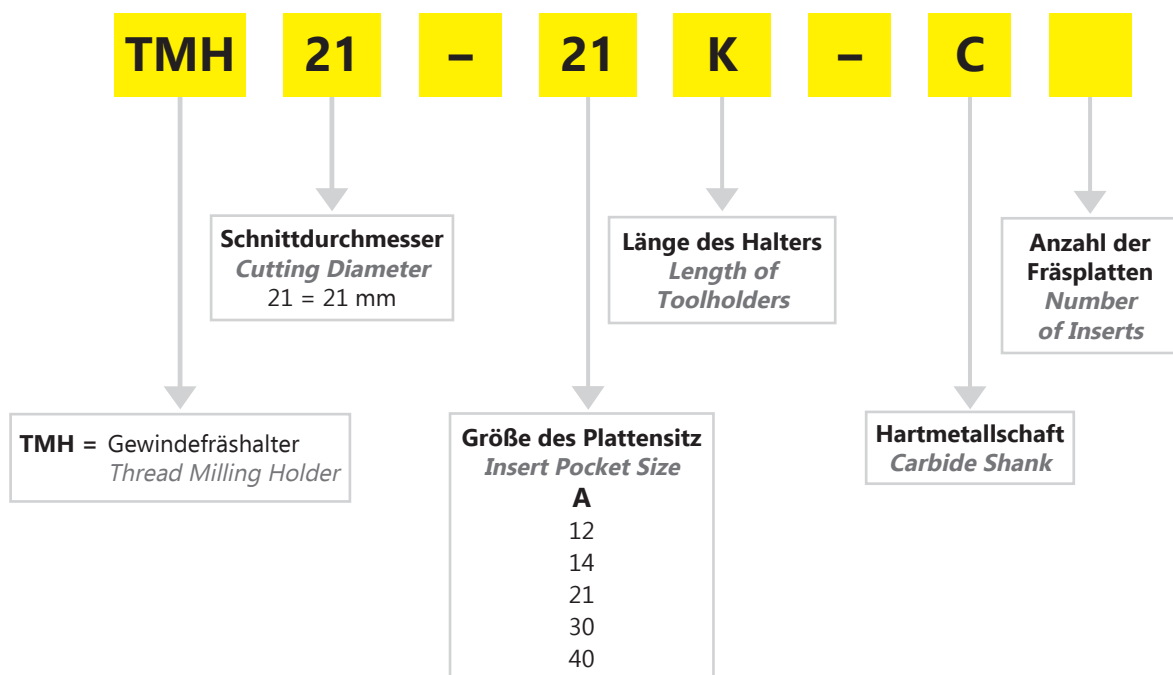

TMH

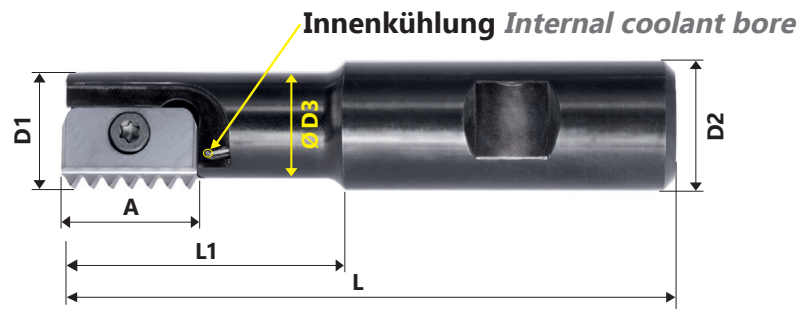

Halter mit einem Plattensitz | Single Insert Toolholders

Artikelnummer (Item Number)	Maße in mm (Dimensions in mm)						Spannschraube (Insert Screw)	Torx Schlüssel (Torx Key)
	A	D1	D2	D3	L 1 (SL)	L (GL)		
TMH09-12H	12	9.5	20	7.5	14	85	S12	TX12
TMH10-12H	12	9.9	20	7.6	16	85	S12	TX12
TMH12-14F	14	12.0	20	8.9	20	75	S14	TX14
TMH14-14H	14	14.5	20	11.2	25	85	S14	TX14
TMH17-14H	14	17.0	20	13.4	30	85	S14	TX14
TMH18-21H*	21	18.0	20	14.4	30	85	S21	TX21
TMH21-21H	21	21.0	20	16.5	40	94	S21	TX21
TMH29-30J	30	29.0	25	22.4	50	110	S30	TX30
TMH48-40M	40	48.0	40	35.0	78	153	S40	TX40

*Passt nicht für folgende Platten | Can not be used with the following inserts: 21IN3.5ISO, 21IN8UN, 21IN7UN, 21EX/IN11BSPT, 21EX/IN11.5NPT, 21EX/IN11.5NPTF

TMH - L



Halter lange Ausführung | long shank toolholders

Artikelnummer (Item Number)	Maße in mm (Dimensions in mm)				Spannschraube (Insert Screw)	Torx Schlüssel (Torx Key)
	A	D1	D2	L (GL)		
TMH25-21K	21	25	20	125	S21	TX21
TMH31-30M	30	31	25	150	S30	TX30
TMH38-30M	30	38	32	150	S30	TX30
TMH48-40R	40	48	40	210	S40	TX40

Für Halter mit langem Überhang die Schnittgeschwindigkeit und Vorschub herabsetzen
zwischen 20% und 40%, je nach Werkstück, Material, Steigung und Überhang
For holders with long overhang reduce the cutting speed and feed rate by
20% to 40%, depending on workpiece material, pitch and overhang

TMH

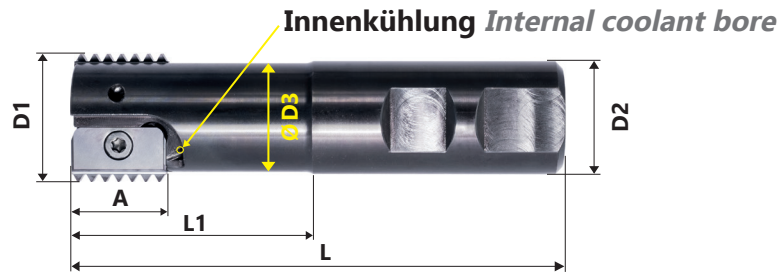

Halter mit zwei Plattensitzen | double sided Insert Toolholders

Artikelnummer (Item Number)	Maße in mm (Dimensions in mm)						Spannschraube (Insert Screw)	Torx Schlüssel (Torx Key)	Anz. der Platten (No. of Inserts)
	A	D1	D2	D3	L1	L			
TMH20-14H-2	14	20	20	16	41	93	S14	TX14	2
TMH30-21J-2	21	30	25	24	52	108	S21	TX21	2
TMH40-30L-2	30	40	32	30	70	130	S30	TX30	2
TMH50-40M-2	40	50	40	38	78	153	S40	TX40	2

TMH - L



VHM-Halter, lange Ausführung | Long Carbide Shank Toolholders

Artikelnummer (Item Number)	Maße in mm (Dimensions in mm)				Spannschraube (Insert Screw)	Torx Schlüssel (Torx Key)
	A	D1	D2	L		
TMH10-12KC*	12	9.9	8	125	S12	TX12
TMH13-14HC	14	13.2	10	110	S14	TX14
TMH13-14JC	14	13.2	10	155	S14	TX14
TMH15-14KC	14	15.2	12	175	S14	TX14
TMH21-21KC	21	21.0	16	130	S21	TX21
TMH21-21MC	21	21.0	16	200	S21	TX21
TMH27-30SC	30	27.0	20	270	S30	TX30

*ohne Innenkühlung | without coolant bore

Für Halter mit langem Überhang die Schnittgeschwindigkeit herabsetzen zwischen 20-40%, je nach Werkstück, Material, Steigung und Überhang
 Holders with long overhang reduce the cutting speed by 20-40%, depending on workpiece, material, pitch and overhang

TEST REPORT

Innengewinde (Internal thread)	M42 x 3
Gewindetiefe (Thread depth)	30.0 mm
Werkstoff (Material)	Rostfreier Stahl (Stainless Steel) : 1.4571
Werkzeug (Tool)	Halter (Holder) : TMH21-21H Platte (Insert) : 21IN3.0ISO
Schnittgeschwindigkeit (Cutting parameters)	Vc: 135 m/min Fz: 0.072 mm/Z
Kühlung (Coolant)	Emulsion
Standzeit (Tool life)	443 Teile, beide Schneidkanten wurden benutzt) (443 Pieces, both cutting edges were used)

Die Umrechnung der gewählten Schnittgeschwindigkeit in die Drehgeschwindigkeit erfolgt nach folgender Formel:
(Conversion of selected cutting speed to rotational speed is calculated using the following formula):

$$N = \frac{V_c \times 1000}{\pi \times D} = \frac{120 \times 1000}{3.14 \times 30} = 1274 \frac{\text{UPM}}{\text{RPM}}$$

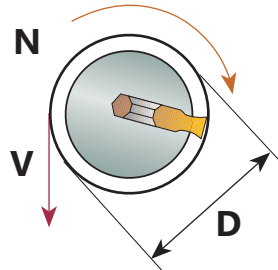

Beispiel $V_c = 120$ m/min
(Example) $D = 30$ mm
 $D =$ Schnittdurchmesser
(Cutting Diameter)

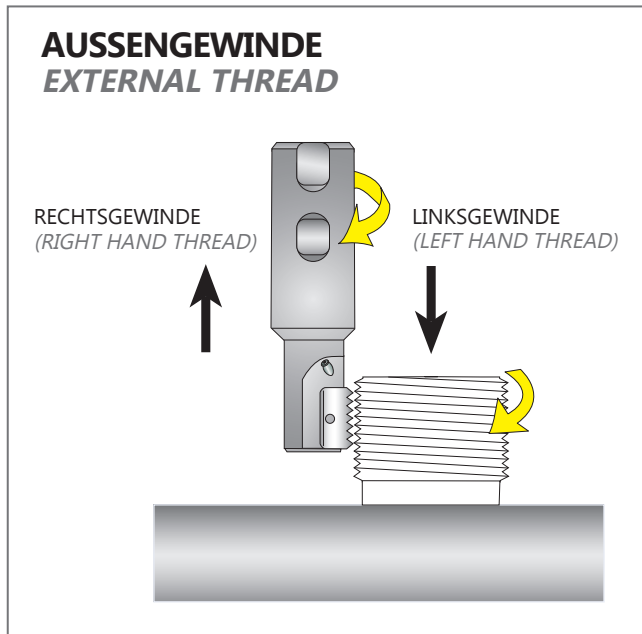
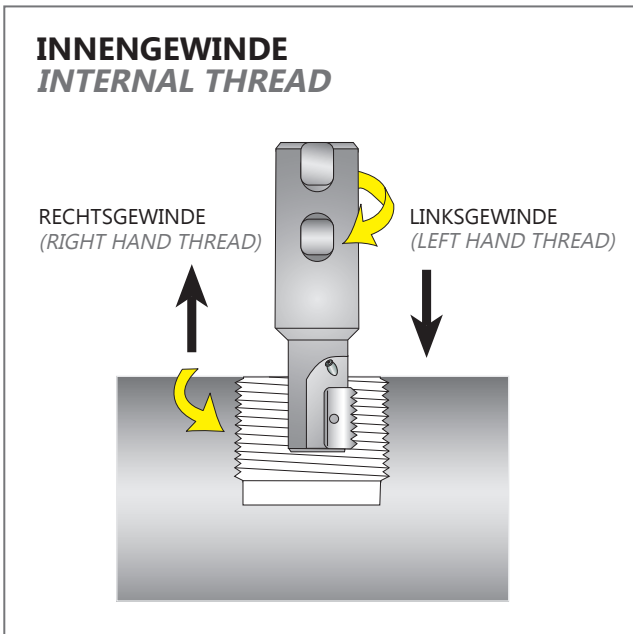

WERKZEUGAUSWAHL (TOOL SELECTION)

FÜR WENDEPLATTEN- & VOLLHARTMETALL-GEWINDEFÄSER
(FOR INDEXABLE AND SOLID CARBIDE THREAD MILLING CUTTERS)

Bei der Auswahl ist zu beachten, dass der Schnittdurchmesser des Werkzeugs kleiner sein muss, als der Durchmesser des Gewindes.
(Choosing a tool, please note that a tool diameter should be smaller than thread diameter.)

Beispiel: Innengewinde M30 x 1.5:

Sie suchen einen Fräser, der ein $d = 30$ mm IN-RH ISO Gewinde bei einer Gewindesteigung von $P = 1.5$ mm herstellt.

(**Example:** Internal thread M30 x 1.5:

You are looking for a Milling Cutter to produce $d = 30$ mm internal right hand ISO thread with a thread pitch $P = 1.5$ mm)

Gewählter Halter (Chosen toolholder): TMH21-21H
Fräsplatte (Insert): 21IN1.5ISO TiAlN

Falls Sie technische Beratung benötigen, wenden Sie sich bitte an unseren Vertreter vor Ort und fragen Sie nach dem passenden Werkzeug sowie nach einem CNC-Programm, das für Ihre CNC-Fräsmaschine geeignet ist.

(If you need technical assistance, please call your local representative and ask for help in selecting the appropriate tool as well as for a CNC program to suit your CNC milling machine.)

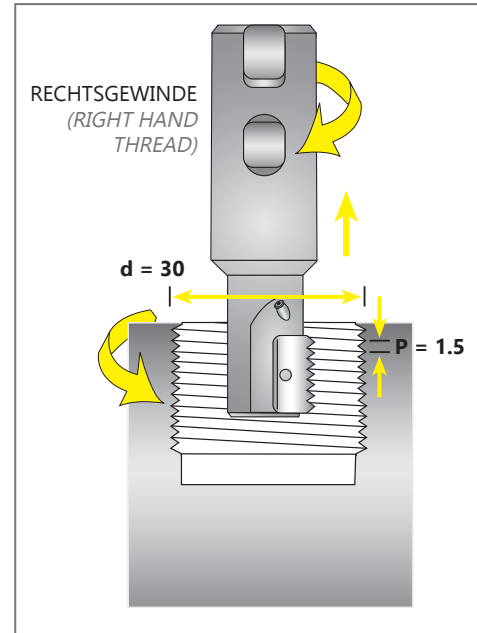

AUSWAHL DER SCHNITTGESCHWINDIGKEIT UND DES VORSCHUBS FÜR GEWINDEFÄSERPLATTEN

(MILL THREAD INSERTS SPEED AND FEED SELECTION)

TiAlN – Ultra-Feinstkorn-Qualität mit einer Titan Aluminium Nitrid-Mehrfachbeschichtung (ISO K10-K20). Generell für alle Werkstoffe geeignet, es sollte bei mittleren bis hohen Schnittgeschwindigkeiten laufen.

(**TiAlN** – Sub-Micron Grade with Titanium Aluminium Nitride multi-layer coating (ISO K10-K20). This is a general purpose grade, which can be used with all materials, it should be run at medium to high cutting speeds.)

Empfohlene Vorschubrate: 0.05 - 0.15 mm (Recommended Feed Rate: 0.05 - 0.15 mm)

ISO	Material	Schnittgeschwindigkeit (Cutting Speed) Vc (m/min)TiAlN
P	Niedrig - & Mittel-Legierter Kohlenstoffstahl (Low and Medium Carbon Steels)	115 - 280
	Hoch-Legierter Kohlenstoffstahl (High Carbon Steels)	130 - 200
	Legierter Stahl (Treated Steels)	105 - 180
M	Rostfreier Stahl, rostfreier Stahlguss (Stainless Steels, Cast Stainless Steels)	130 - 190
	Stahlguss (Cast Steels)	150 - 190
K	Gusseisen (Cast Iron)	80 - 170
N	NE-Metalle und Aluminium (Non-Ferrous and Aluminum)	180 - 340
	Synthetics, Duroplaste, Thermoplaste (Synthetics, Duroplastics, Thermoplastics)	115 - 460
S	Nickellegierungen, Titanlegierungen (Nickel Alloys, Titanium Alloys)	25 - 90

9

VHM-GEWINDEFÄSER

SOLID CARBIDE THREAD MILLS

Gewindefräser für den Einsatz auf CNC-Fräsmaschinen bei Benutzung von Schraubeninterpolationsprogrammen.

(Thread Milling cutters for helical interpolation on CNC milling machines.)

VORTEILE

- das gleiche Werkzeug kann für eine Vielzahl von Materialien verwendet werden
- Schnittdurchmesser von 2.2 mm aufwärts
- längere Standzeit durch spezielle Mehrfachbeschichtung
- ein Werkzeug für Rechts- und Linksgewinde
- Spannuten erlauben einen weichen Schnitt
- kürzere Maschinenzeiten durch 3 bis 6 Schneiden
- das Gewinde wird in nur einem Arbeitsgang hergestellt
- geringer Schnittdruck erlaubt die Bearbeitung dünnwandiger Werkstücke
- Durchgangs- und Sacklochgewinde
- hervorragende Oberflächengüte

ADVANTAGES:

- *same tool can be used for a variety of materials*
- *cutting diameter 2.2 mm and up*
- *longer tool life thanks to a special multi-layer coating process*
- *same tool used for r.h. & l.h. threads*
- *spiral flutes allow smooth cutting operation*
- *shorter machining time due to 3 to 6 simultaneously engaged cutting edges*
- *thread is generated in one pass*
- *low cutting pressure allows thin wall machining*
- *threads in through and blind holes*
- *excellent surface finish*

TMC - Für NE-Metalle ohne IK *(Thread Mills for non-ferrous without internal coolant bore)*

TMCC - Besonders geeignet für Sacklöcher *(Thread Mills with internal coolant bore for blind holes)*

TMCF - Spanableitung durch Kühlmittel *(Thread Mills with chips evacuation via coolant fluty)*

TMCL - Mit abgesetztem Schaft und Innenkühlung *(Thread Mills with runout with internal coolant)*



PRODUKT BEZEICHNUNG (PRODUCT DESIGNATION)

BEISPIEL (EXAMPLE): TMC0604-3-14-1.0 ISO

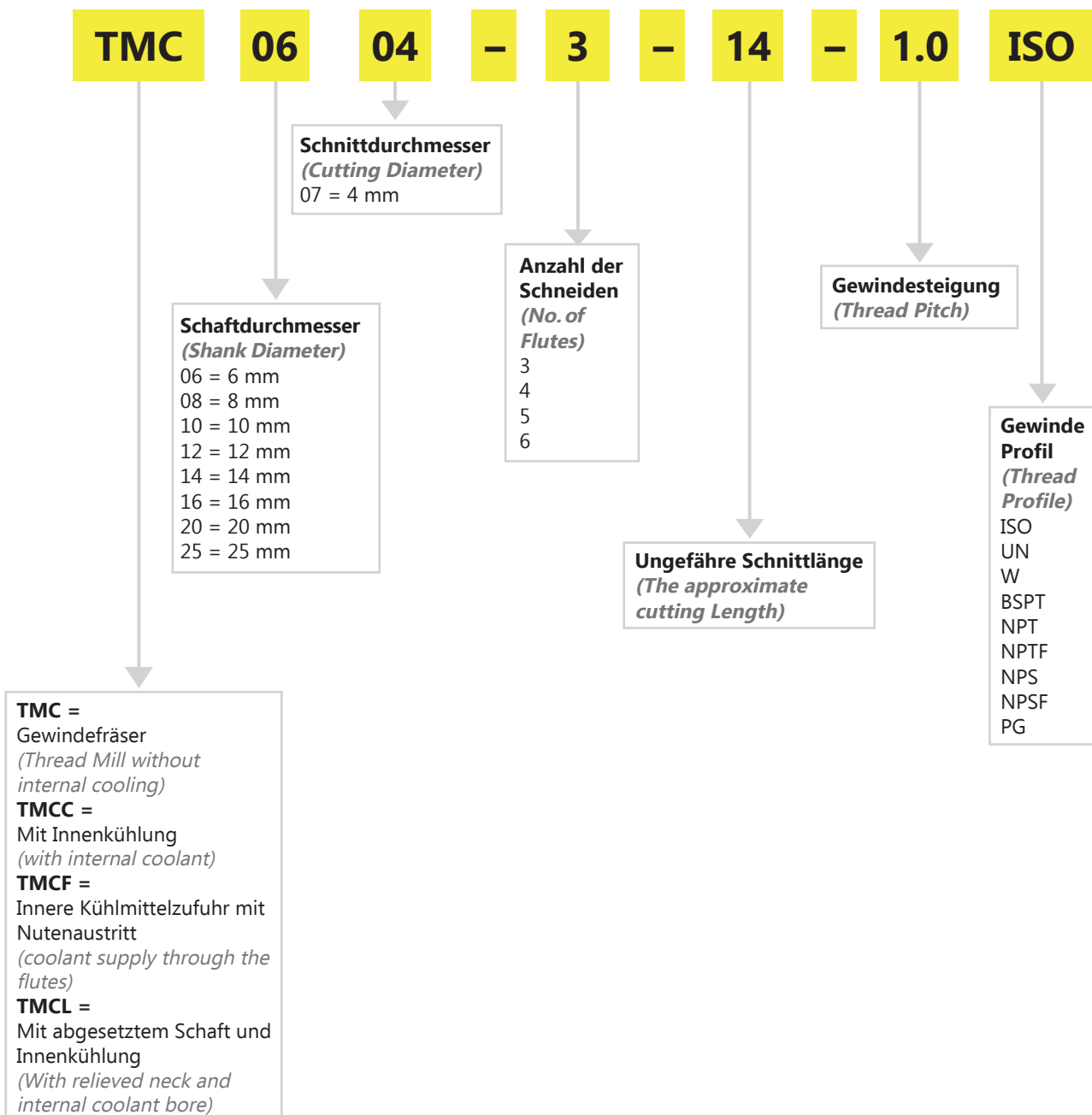

ISO

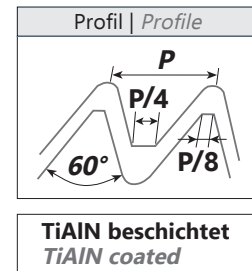
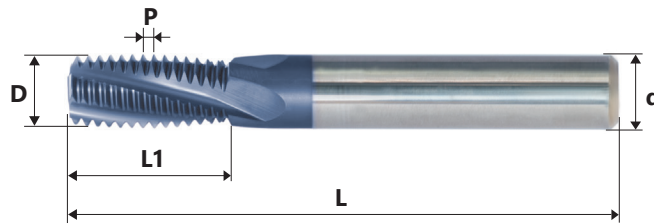

Werkzeuge zur Herstellung von Innengewinden | tools for internal threads

Artikelnummer (Item Number)	Maße in mm (Dimensions in mm)							Schneiden (Flutes)
	M grob (coarse)	P Steigung (Pitch)	M fein (fine)	D	d	L1	L	
TMC06022-3-5-0.5ISO	M3	0.5	Ø 4	2.2	6	5.3	58	3
TMC06038-3-10-0.5ISO		0.5	Ø 5	3.8	6	10.3	58	3
TMC06031-3-7-0.7ISO	M4	0.7	Ø 5	3.1	6	7.4	58	3
TMC06045-3-10-0.75ISO		0.75	Ø 6	4.5	6	10.1	58	3
TMC06036-3-9-0.8ISO	M5	0.8	Ø 6	3.6	6	9.2	58	3
TMC0604-3-10-1.0ISO	M6	1.0	Ø 7	4.0	6	10.5	58	3
TMC0604-3-14-1.0ISO	M6	1.0	Ø 7	4.0	6	14.5	58	3
TMC0606-3-12-1.0ISO		1.0	Ø 9	6.0	6	12.5	58	3
TMC0808-4-16-1.0ISO		1.0	Ø 10	8.0	8	16.5	64	4
TMC0605-3-14-1.25ISO	M8	1.25	Ø 10	5.0	6	14.4	58	3
TMC0605-3-19-1.25ISO	M8	1.25	Ø 10	5.0	6	19.4	58	3
TMC0807-3-17-1.5ISO	M10	1.5	Ø 12	7.0	8	17.3	64	3
TMC0807-3-24-1.5ISO	M10	1.5	Ø 12	7.0	8	24.8	76	3
TMC1010-4-21-1.5ISO		1.5	Ø 14	10.0	10	21.8	73	4
TMC1616-6-33-1.5ISO		1.5	Ø 20	16.0	16	33.8	105	6
TMC0808-3-20-1.75ISO	M12	1.75	Ø 14	8.0	8	22.1	64	3
TMC0808-3-28-1.75ISO	M12	1.75	Ø 14	8.0	8	28.9	76	3
TMC1010-3-27-2.0ISO	M16	2.0	Ø 17	10.0	10	27.0	73	3
TMC1010-3-39-2.0ISO	M16	2.0	Ø 17	10.0	10	39.0	105	3
TMC1212-4-27-2.0ISO		2.0	Ø 18	12.0	12	27.0	84	4
TMC2020-6-41-2.0ISO		2.0	Ø 26	20.0	20	41.0	108	6
TMC1414-4-33-2.5ISO	M20	2.5	Ø 22	14.0	14	33.8	84	4
TMC1414-4-48-2.5ISO	M20	2.5	Ø 22	14.0	14	48.8	105	4
TMC1616-3-40-3.0ISO	M24	3.0	Ø 25	16.0	16	40.5	105	3
TMC1616-3-58-3.0ISO	M24	3.0	Ø 25	16.0	16	58.5	120	3
TMC2020-4-43-3.0ISO	M27	3.0	Ø 28	20.0	20	43.5	105	4

Für Gewindefräser mit Innenkühlung siehe folgende Seiten | For thread mills with coolant bore see the following pages
 Mini-Gewindefräser siehe Seite 169-183 | Mini thread mills see page 169-183

ISO

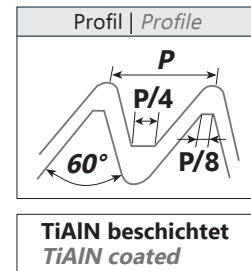
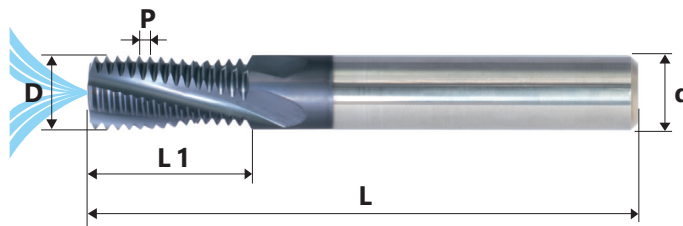

mit Innenkühlung – Werkzeuge zur Herstellung von Innengewinden
with internal coolant bore – tools for internal threads

Artikelnummer (Item Number)	Maße in mm (Dimensions in mm)							Schneiden (Flutes)
	P Steigung (Pitch)	M grob (coarse)	M fein (fine)	D	d	L1	L	
TMCC06038-3-10-0.5ISO	0.5		Ø 5	3.8	6	10.3	58	3
TMCC06031-3-7-0.7ISO	0.7	M4	Ø 5	3.1	6	7.4	58	3
TMCC06045-3-10-0.75ISO	0.75		Ø 6	4.5	6	10.1	58	3
TMCC1010-4-24-0.75ISO	0.75		Ø 12	10.0	10	24.4	73	4
TMCC06038-3-9-0.8ISO	0.8	M5	Ø 6	3.8	6	9.2	58	3
TMCC06046-3-10-1.0ISO	1.0	M6	Ø 7	4.6	6	10.5	58	3
TMCC06046-3-14-1.0ISO	1.0	M6	Ø 7	4.6	6	14.5	58	3
TMCC0606-3-12-1.0ISO	1.0		Ø 9	6.0	6	12.5	58	3
TMCC0808-4-16-1.0ISO	1.0		Ø 10	8.0	8	16.5	64	4
TMCC1010-4-24-1.0ISO	1.0		Ø 12	10.0	10	24.5	73	4
TMCC0606-3-14-1.25ISO	1.25	M8	Ø 10	6.0	6	14.4	58	3
TMCC0606-3-19-1.25ISO	1.25	M8	Ø 10	6.0	6	19.4	58	3
TMCC08078-3-17-1.5ISO	1.5	M10	Ø 12	7.8	8	17.0	64	3
TMCC08078-3-24-1.5ISO	1.5	M10	Ø 12	7.8	8	24.8	76	3
TMCC1010-4-21-1.5ISO	1.5		Ø 14	10.0	10	21.8	73	4
TMCC1212-4-26-1.5ISO	1.5		Ø 16	12.0	12	26.3	84	4
TMCC1616-6-33-1.5ISO	1.5		Ø 20	16.0	16	33.8	105	6
TMCC1009-3-20-1.75ISO	1.75	M12	Ø 12	9.0	10	20.1	73	3
TMCC1009-3-28-1.75ISO	1.75	M12	Ø 12	9.0	10	28.9	73	3
TMCC1010-3-27-2.0ISO	2.0	M14	Ø 15	10.0	10	27.0	73	3
TMCC12118-4-27-2.0ISO	2.0	M16	Ø 17	11.8	12	27.0	84	4
TMCC12118-4-39-2.0ISO	2.0	M16	Ø 17	11.8	12	39.0	105	4
TMCC2020-6-41-2.0ISO	2.0		Ø 26	20.0	20	41.0	105	6
TMCC1615-5-33-2.5ISO	2.5	M20	Ø 22	15.0	16	33.8	105	5
TMCC1615-5-48-2.5ISO	2.5	M20	Ø 22	15.0	16	48.8	105	5
TMCC2018-4-40-3.0ISO	3.0	M24	Ø 25	18.0	20	40.5	105	4
TMCC2018-4-58-3.0ISO	3.0	M24	Ø 25	18.0	20	58.5	120	4
TMCC2020-4-43-3.0ISO	3.0	M27	Ø 27	20.0	20	43.5	105	4

Mini-Gewindefräser siehe Seite 169-183 | Mini thread mills see page 169-183

ISO

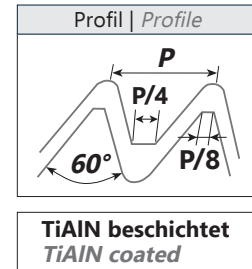
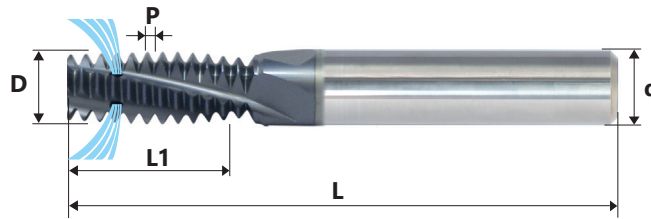

mit innerer Khlmittelzufuhr mit Nutenaustritt - Werkzeuge zur Herstellung von Innengewinden
with internal coolant supply via flutes - tools for internal threads

Artikelnummer (Item Number)	Mae in mm (Dimensions in mm)							Schneiden (Flutes)
	P Steigung (Pitch)	M grob (coarse)	M fein (fine)	D	d	L1	L	
TMCF06048-3-10-1.0ISO	1.0	M6	Ø 7	4.8	6	10.5	58	3
TMCF0606-3-12-1.0ISO	1.0		Ø 9	6.0	6	12.5	58	3
TMCF0808-4-16-1.0ISO	1.0		Ø 10	8.0	8	16.5	64	4
TMCF0606-3-14-1.25ISO	1.25	M8	Ø 10	6.0	6	14.4	58	3
TMCF0606-3-19-1.25ISO	1.25	M8	Ø 10	6.0	6	19.4	58	3
TMCF08078-3-17-1.5ISO	1.5	M10	Ø 12	7.8	8	17.0	64	3
TMCF1010-4-21-1.5ISO	1.5		Ø 14	10.0	10	21.8	73	4
TMCF1212-4-26-1.5ISO	1.5		Ø 16	12.0	12	26.3	84	4
TMCF1616-5-33-1.5ISO	1.5		Ø 20	16.0	16	33.8	101	5
TMCF1009-3-20-1.75ISO	1.75	M12	Ø 12	9.0	10	20.1	73	3
TMCF1009-3-28-1.75ISO	1.75	M12	Ø 12	9.0	10	28.9	73	3
TMCF1010-3-27-2.0ISO	2.0	M14	Ø 15	10.0	10	27.0	73	3
TMCF12118-4-27-2.0ISO	2.0	M16	Ø 17	11.8	12	27.0	84	4
TMCF1615-5-33-2.5ISO	2.5	M20	Ø 22	15.0	16	33.8	101	5

Mini-Gewindefhrer siehe Seite 169-183 | Mini thread mills see page 169-183

ISO

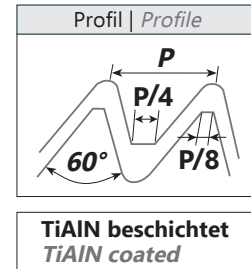
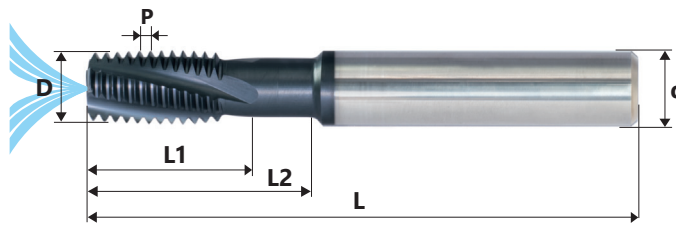

mit abgesetztem Schaft und Innenkühlung - Werkzeuge zur Herstellung von Innengewinden
with relieved neck and internal coolant bore - tools for internal threads

Artikelnummer (Item Number)	Maße in mm (Dimensions in mm)							Schneiden (Flutes)
	P Steigung (Pitch)	M fein (fine)	D	d	L1	L2	L	
TMCL1010-4-32-1.0ISO	1.0	Ø 12	10	10	18.0	32.0	73	4
TMCL1212-4-38-1.0ISO	1.0	Ø 14	12	12	21.0	38.0	84	4
TMCL1616-6-45-1.0ISO	1.0	Ø 18	16	16	26.0	45.0	105	6
TMCL1010-4-30-1.5ISO	1.5	Ø 13	10	10	18.0	30.0	73	4
TMCL1212-4-34-1.5ISO	1.5	Ø 15	12	12	19.5	34.5	84	4
TMCL1616-6-43-1.5ISO	1.5	Ø 19	16	16	25.5	43.5	105	6
TMCL2020-6-60-1.5ISO	1.5	Ø 23	20	20	36.0	60.0	105	6
TMCL1212-4-42-2.0ISO	2.0	Ø 16	12	12	24.0	42.0	84	4
TMCL1616-5-45-2.0ISO	2.0	Ø 20	16	16	26.0	45.0	105	5
TMCL2020-6-56-2.0ISO	2.0	Ø 24	20	20	34.0	56.0	105	6
TMCL1616-4-45-3.0ISO	3.0	Ø 22	16	16	30.0	45.0	105	4
TMCL2020-5-54-3.0ISO	3.0	Ø 26	20	20	33.0	54.0	105	5
TMCL2020-4-45-3.5ISO	3.5	Ø 26	20	20	28.0	45.5	105	4

Mini-Gewindefräser siehe Seite 169-183 | Mini thread mills see page 169-183

G55° - BSF, BSP

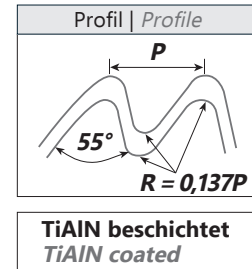
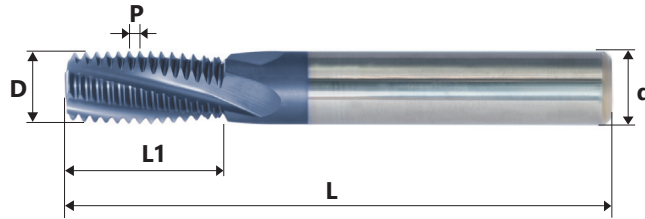

BSF, BSP - gleiches Werkzeug für Innen- und Außengewinde

BSF, BSP - same tool for internal and external threads

Artikelnummer (Item Number)	Maße in mm (Dimensions in mm)						Schneiden (Flutes)
	P Steigung (Pitch)	Standard	D	d	L1	L	
TMC0606-3-9-28W	28	G1/8	6	6	9.5	58	3
TMC0808-3-1419W	19	G1/4-3/8	8	8	14.0	64	3
TMC1212-4-19-14W	14	G1/2-7/8	12	12	19.0	84	4
TMC1212-4-26-14W	14	G1/2-7/8	12	12	26.3	84	4
TMC1212-3-24-11W	11	G \geq 1	12	12	24.2	84	3
TMC1616-4-38-11W	11	G \geq 1	16	16	38.1	105	4
TMC2020-5-47-11W	11	G \geq 1	20	20	47.3	105	5

Mini-Gewindefräser siehe Seite 169-183 | Mini thread mills see page 169-183

G55° - BSF, BSP

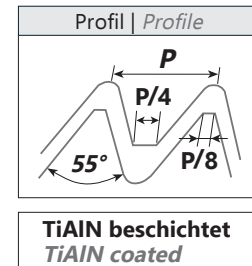
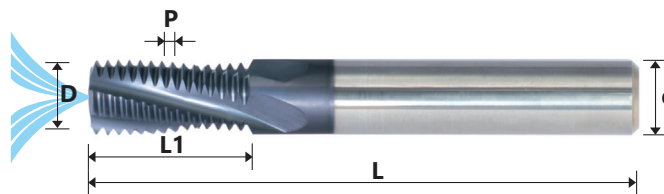

BSF, BSP mit Innenkühlung – gleiches Werkzeug für Innen- und Außengewinde

BSF, BSP with internal coolant bore – same tool for internal and external threads

Artikelnummer (Item Number)	Steigung (Pitch) P in TPI	Standard	d in mm	D in mm	L1 in mm	L in mm	Schneiden (Flutes)
TMCC08078-3-14-28W	28	G1/8	8	7.8	14.1	64	3
TMCC1010-4-16-19W	19	G1/4-3/8	10	10.0	16.7	73	4
TMCC1616-5-26-14W	14	G1/2-7/8	16	16.0	26.3	105	5
TMCC1616-4-38-11W	11	G \geq 1	16	16.0	38.1	105	4
TMCC2020-5-47-11W	11	G \geq 1	20	20.0	47.3	105	5

Mini-Gewindefräser siehe Seite 169-183 | Mini thread mills see page 169-183

G55° - BSF, BSP

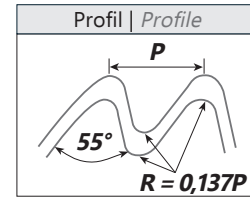
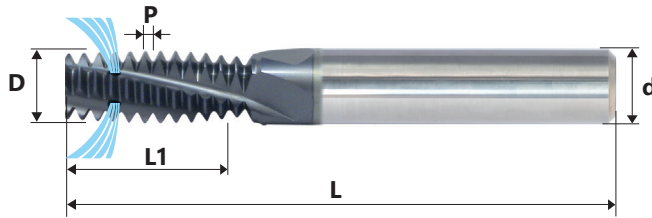

TiAlN beschichtet
TiAlN coated

BSF, BSP mit innerer Kühlmittelzufuhr mit Nutenaustritt - gleiches Werkzeug für Innen- und Außengewinde
BSF, BSP with internal coolant supply through the flutes - same tool for internal and external threads

Artikelnummer (Item Number)	Steigung (Pitch) P in TPI	Standard	d in mm	D in mm	Schneiden (Flutes)	L1 in mm	L in mm
TMCF08078-3-14-28W	28	G1/8	8	7.8	3	14.1	64
TMCF1010-4-16-19W	19	G1/4-3/8	10	10.0	4	16.7	73
TMCF1616-5-26-14W	14	G1/2-7/8	16	16.0	5	26.3	101
TMCF1616-4-38-11W	11	G≥1	16	16.0	4	38.1	101

Mini-Gewindefräser siehe Seite 169-183 | Mini thread mills see page 169-183

WHITWORTH - BSW

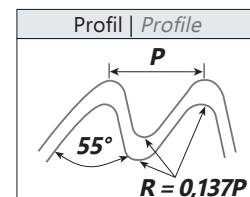
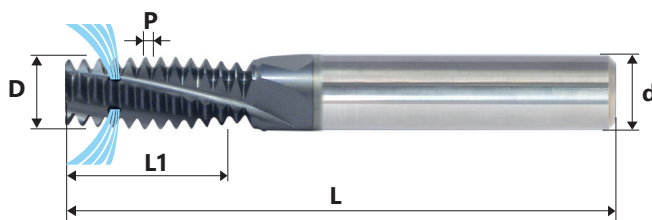

TiAlN beschichtet
TiAlN coated

BSW mit innerer Kühlmittelzufuhr mit Nutenaustritt - gleiches Werkzeug für Innen- und Außengewinde
BSW with internal coolant supply through the flutes - same tool for internal and external threads

Artikelnummer (Item Number)	Steigung (Pitch) P in TPI	Standard	d in mm	D in mm	Schneiden (Flutes)	L1 in mm	L in mm
TMCF06046-3-12-20W	*20	1/4	6	4.6	3	12.1	58
TMCF06053-3-14-18W	18	5/16	6	5.3	3	14.8	58
TMCF08068-3-16-16W	16	3/8	8	6.8	3	16.7	64
TMCF10092-4-24-16W	16	1/2	10	9.2	4	24.6	73
TMCF08078-4-20-14W	14	7/16	8	7.8	4	20.9	64
TMCF10086-4-24-12W	12	1/2	10	8.6	4	24.4	73
TMCF12109-4-28-11W	11	5/8	12	10.9	4	28.9	84

* Fräser ohne Innenkühlung | Cutter without coolant

UN

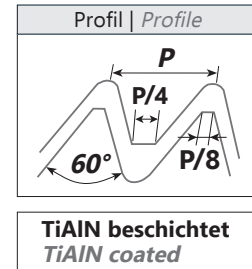
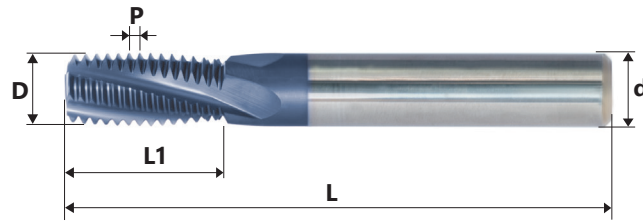

Werkzeuge zur Herstellung von Innengewinden | tools for internal threads

Artikelnummer (Item Number)	Steigung (Pitch) P in TPI	UNC	UNF	UNFE	d in mm	D in mm	Schneiden (Flutes)	L1 in mm	L in mm
TMC06025-3-6-40UN	40	5			6	2.5	3	6.0	58
TMC06032-3-6-32UN	32	8	10	12	6	3.2	3	6.8	58
TMC0604-3-11-28UN	28		1/4		6	4.0	3	11.3	58
TMC0606-3-14-28UN	28			7/16-1/2	6	6.0	3	14.1	58
TMC0605-3-14-24UN	24		5/16		6	5.0	3	14.3	58
TMC0807-3-21-24UN	24		3/8	9/16-5/8	8	7.0	3	20.6	64
TMC06045-3-12-20UN	20	1/4			6	4.5	3	12.1	58
TMC0807-3-21-20UN	20		7/16-1/2		8	7.0	3	21.0	64
TMC1212-5-27-20UN	20			3/4-1	12	12.0	5	27.3	84
TMC0605-3-14-18UN	18	5/16			6	5.0	3	14.8	58
TMC1010-4-26-18UN	18		9/16-5/8	1 ^{1/8} -1 ^{5/8}	10	10.0	4	26.1	73
TMC0606-3-16-16UN	16	3/8			6	6.0	3	16.7	58
TMC1212-4-31-16UN	16		3/4		12	12.0	4	31.0	84
TMC0807-3-20-14UN	14	7/16			8	7.0	3	20.9	64
TMC1615-5-37-14UN	14		7/8		16	15.0	5	37.2	105
TMC0808-3-22-13UN	13	1/2			8	8.0	3	22.5	64
TMC1010-3-26-12UN	12	9/16			10	10.0	3	26.5	73
TMC1616-5-41-12UN	12		1-1 ^{1/2}		16	16.0	5	41.3	105
TMC1010-3-28-11UN	11	5/8			10	10.0	3	28.9	73
TMC1212-3-34-10UN	10	3/4			12	12.0	3	34.3	84
TMC1615-3-38-9UN	9	7/8			16	15.0	3	38.1	150
TMC1616-3-42-8UN	8	1			16	16.0	3	42.9	105
TMC2020-4-45-7UN	7	1 ^{1/8} -1 ^{1/4}			20	20.0	4	45.3	105

Für Gewindefräser mit Innenkühlung siehe folgende Seiten | For thread mills with coolant bore see following pages
Mini-Gewindefräser siehe Seite 169-183 | Mini thread mills see page 169-183

UN

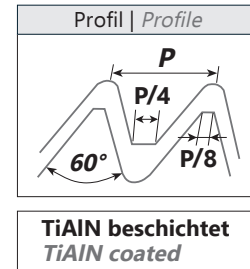
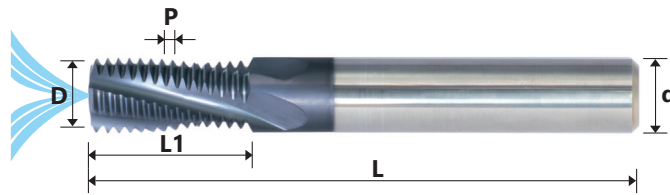

mit Innenkühlung - Werkzeuge zur Herstellung von Innengewinden
with internal coolant bore - tools for internal threads

Artikelnummer (Item Number)	Steigung (Pitch) P in TPI	UNC	UNF	UNFE	d in mm	D in mm	Schneiden (Flutes)	L1 in mm	L in mm
TMCC06032-3-6-32UN	32	8	10	12	6	3.2	3	6.8	58
TMCC0606-3-14-32UN	32			5/16	6	6.0	3	14.7	58
TMCC0808-4-18-32UN	32			3/8	8	8.0	4	18.7	64
TMCC0605-3-11-28UN	28		1/4		6	5.0	3	11.3	58
TMCC0606-3-14-28UN	28			7/16-1/2	6	6.0	3	14.1	58
TMCC08066-3-14-24UN	24		5/16		8	6.6	3	14.3	64
TMCC0808-4-21-24UN	24		3/8	9/16-5/8	8	8.0	4	20.6	64
TMCC06047-3-12-20UN	20	1/4			6	4.7	3	12.1	58
TMCC0808-3-21-20UN	20		7/16		8	8.0	3	21.0	64
TMCC1010-4-22-20UN	20		1/2		10	10.0	4	22.3	73
TMCC1212-5-27-20UN	20			3/4-1	12	12.0	5	27.3	84
TMCC06056-3-14-18UN	18	5/16			6	5.6	3	14.8	58
TMCC12113-4-26-18UN	18		9/16-5/8	1 ^{1/8} - 1 ^{1/4}	12	11.3	4	26.1	84
TMCC08067-3-16-16UN	16	3/8			8	6.7	3	16.7	64
TMCC1212-4-31-16UN	16		3/4		12	12.0	4	31.0	84
TMCC08077-3-20-14UN	14	7/16			8	7.7	3	20.9	64
TMCC1616-5-37-14UN	14		7/8		16	16.0	5	37.2	105
TMCC10092-3-22-13UN	13	1/2			10	9.2	3	22.5	73
TMCC12105-3-26-12UN	12	9/16			12	10.5	3	26.5	84
TMCC1616-5-41-12UN	12		1 - 1 ^{1/2}		16	16.0	5	41.3	105
TMCC12114-3-28-11UN	11	5/8			12	11.4	3	28.9	84
TMCC16144-4-34-10UN	10	3/4			16	14.4	4	34.3	105
TMCC1616-3-38-9UN	9	7/8			16	16.0	3	38.1	105
TMCC20195-4-42-8UN	8	1			20	19.5	4	42.9	105
TMCC2020-4-45-7UN	7	1 ^{1/8} - 1 ^{1/4}			20	20.0	4	45.3	105

Mini-Gewindefräser siehe Seite 169-183 | Mini thread mills see page 169-183

UN

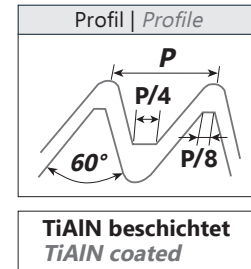
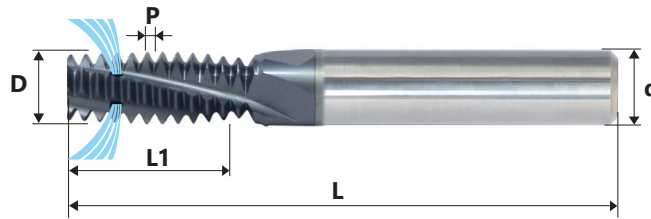

innere Khlmittelzufuhr mit Nutenaustritt - Werkzeuge zur Herstellung von Innengewinden
with internal coolant supply through the flutes - tools for internal threads

Artikelnummer (Item Number)	Steigung (Pitch) P in TPI	UNC	UNF	UNFE	d in mm	D in mm	Schneiden (Flutes)	L1 in mm	L in mm
TMCF0605-3-11-28UN	28		1/4		6	5.0	3	11.3	58
TMCF0606-3-14-28UN	28			7/16-1/2	6	6.0	3	14.1	58
TMCF08066-3-14-24UN	24		5/16		8	6.6	3	14.3	64
TMCF0808-4-21-24UN	24		3/8	9/16-5/8	8	8.0	4	20.6	64
TMCF0808-3-21-20UN	20		7/16		8	8.0	3	21.0	64
TMCF1010-4-22-20UN	20		1/2		10	10.0	4	22.3	73
TMCF1212-5-27-20UN	20			3/4-1	12	12.0	5	27.3	84
TMCF06056-3-14-18UN	18	5/16			6	5.6	3	14.8	58
TMCF12113-4-26-18UN	18		9/16-5/8	1 ¹ / ₈ - 1 ⁵ / ₈	12	11.3	4	26.1	84
TMCF08067-3-16-16UN	16	3/8			8	6.7	3	16.7	64
TMCF1212-4-31-16UN	16		3/4		12	12.0	4	31.0	84
TMCF08077-3-20-14UN	14	7/16			8	7.7	3	20.9	64
TMCF1616-5-37-14UN	14		7/8		16	16.0	5	37.2	101
TMCF10092-3-22-13UN	13	1/2			10	9.2	3	22.5	73
TMCF12105-3-26-12UN	12	9/16			12	10.5	3	26.5	84
TMCF12114-3-28-11UN	11	5/8			12	11.4	3	28.9	84
TMCF16144-4-34-10UN	10	3/4			16	14.4	4	34.3	101

Mini-Gewindefhrer siehe Seite 169-183 | Mini thread mills see page 169-183

UN

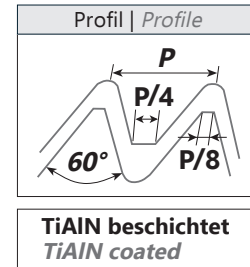
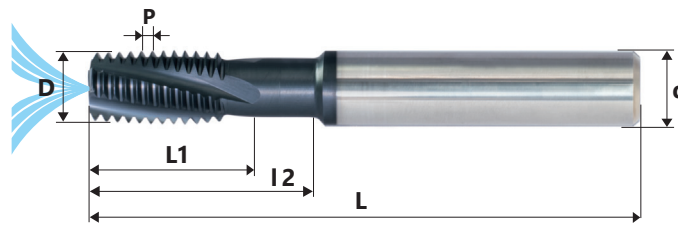

mit abgesetztem Schaft und Innenkühlung - Werkzeuge zur Herstellung von Innengewinden
with relieved neck and internal coolant bore - tools for internal threads

Artikelnummer (Item Number)	Steigung (Pitch) P in TPI	M fein (fine)	d in mm	D in mm	Schneiden (Flutes)	L2 in mm	L1 in mm	L in mm
TMCL1010-4-30-20UN	20	Ø 12	10	10.0	4	17.8	30.5	73
TMCL1212-5-35-20UN	20	Ø 14	12	12.0	5	20.3	35.6	84
TMCL1616-6-43-20UN	20	Ø 18	16	16.0	6	25.4	43.2	105
TMCL1212-4-35-18UN	18	Ø 15	12	12.0	4	19.7	35.3	84
TMCL1212-4-35-16UN	16	Ø 15	12	12.0	4	20.7	35.0	84
TMCL1616-5-42-16UN	16	Ø 19	16	16.0	5	25.4	42.9	105
TMCL2020-6-58-16UN	16	Ø 23	20	20.0	6	36.5	58.8	105
TMCL1616-5-45-14UN	14	Ø 20	16	16.0	5	25.4	45.3	105
TMCL1212-4-42-12UN	12	Ø 16	12	12.0	4	25.4	42.3	84
TMCL2020-5-55-12UN	12	Ø 24	20	20.0	5	33.9	55.1	105

Mini-Gewindefräser siehe Seite 169-183 | Mini thread mills see page 169-183

BSPT

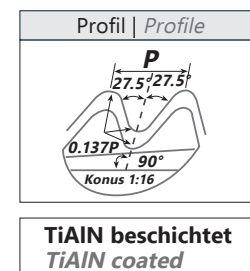
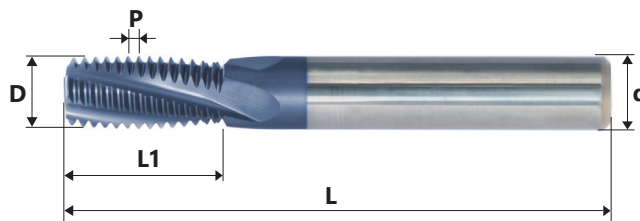

gleiches Werkzeug für Innen- und Außengewinde
same tool for internal and external threads

Artikelnummer (Item Number)	Steigung (Pitch) P in TPI	Standard	d in mm	D in mm	Schneiden (Flutes)	L1 in mm	L in mm
TMC0606-3-9-28BSPT	28	RC 1/16 - 1/8	6	6.0	3	9.5	58
TMC0808-3-14-19BSPT	19	RC 1/4 - 3/8	8	8.0	3	14.0	64
TMC1212-4-19-14BSPT	14	RC 1/2 - 7/8	12	12.0	4	19.1	84
TMC1616-4-28-11BSPT	11	RC 1 - 2	16	16.0	4	28.9	105

Für Vorbearbeitung siehe konische VHM-Schaftfräser siehe Seite 168 | For conical preparation end mills see page 168

BSPT

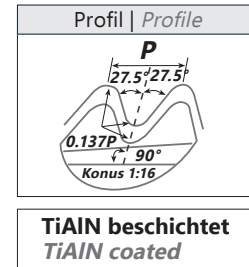
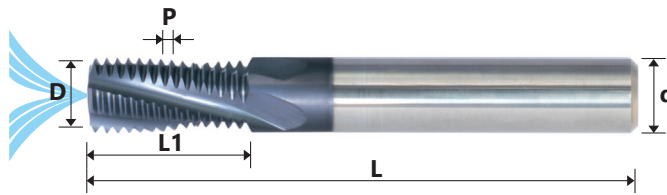

mit Innenkühlung - gleiches Werkzeug für Innen- und Außengewinde
with internal coolant bore - same tool for internal and external threads

Artikelnummer (Item Number)	Steigung (Pitch) P in TPI	Standard	d in mm	D in mm	Schneiden (Flutes)	L1 in mm	L in mm
TMCC08078-3-14-28BSPT	28	RC 1/8	8	7.8	3	14.1	64
TMCC1010-4-16-19BSPT	19	RC 1/4 - 3/8	10	10.0	4	16.7	73
TMCC1616-5-26-14BSPT	14	RC 1/2 - 7/8	16	16.0	5	26.3	105
TMCC1616-4-28-11BSPT	11	RC 1 - 2	16	16.0	4	28.9	105

Für Vorbearbeitung siehe konische VHM-Schaftfräser siehe Seite 168 | For conical preparation end mills see page 168

BSPT

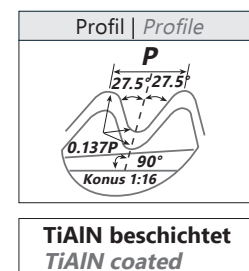
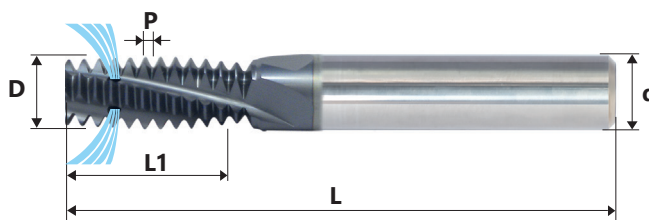

innere Kühlmittelzufuhr mit Nutenaustritt - gleiches Werkzeug für Innen- und Außengewinde
with internal coolant through the flutes - same tool for internal and external threads

Artikelnummer (Item Number)	Steigung (Pitch) P in TPI	Standard	d in mm	D in mm	Schneiden (Flutes)	L1 in mm	L in mm
TMCF08078-3-14-28BSPT	28	RC 1/8	8	7.8	3	14.1	64
TMCF1010-4-16-19BSPT	19	RC 1/4 - 3/8	10	10.0	4	16.7	73
TMCF1616-5-26-14BSPT	14	RC 1/2 - 7/8	16	16.0	5	26.3	101
TMCF1616-4-28-11BSPT	11	RC 1 - 2	16	16.0	4	28.9	101

Für Vorbearbeitung siehe konische VHM-Schaftfräser siehe Seite 168 | For conical preparation end mills see page 168

NPT

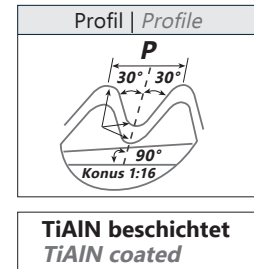
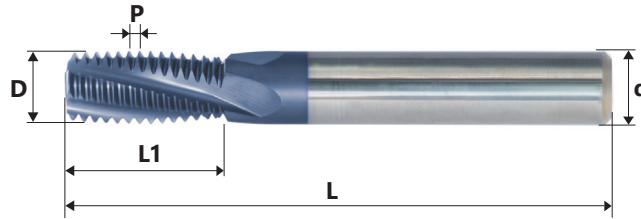

gleiches Werkzeug für Innen- und Außengewinde
same tool for internal and external threads

Artikelnummer (Item Number)	Steigung (Pitch) P in TPI	Standard	d in mm	D in mm	Schneiden (Flutes)	L1 in mm	L in mm
TMC0606-3-9-27NPT	27	1/16 - 1/8	6	6.0	3	9.9	58
TMC0808-3-14-18NPT	18	1/4 - 3/8	8	8.0	3	14.8	64
TMC1212-4-20-14NPT	14	1/2 - 3/4	12	12.0	4	20.9	84
TMC1616-4-27-11.5NPT	11.5	1 - 2	16	16.0	4	27.6	105
TMC2020-4-39-8NPT	8	≥ 2 1/2	20	20.0	4	39.7	105

Für Vorbearbeitung siehe konische VHM-Schaftfräser siehe Seite 168 | For conical preparation end mills see page 168

NPT

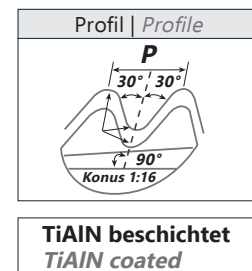
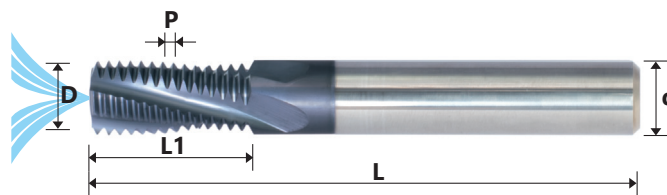

mit Innenkühlung - gleiches Werkzeug für Innen- und Außengewinde
with internal coolant bore - same tool for internal and external threads

Artikelnummer (Item Number)	Steigung (Pitch) P in TPI	Standard	d in mm	D in mm	Schneiden (Flutes)	L1 in mm	L in mm
TMCC08076-3-10-27NPT	27	1/16 - 1/8	8	7.6	3	10.8	64
TMCC1010-4-16-18NPT	18	1/4 - 3/8	10	10.0	4	16.2	73
TMCC16155-4-22-14NPT	14	1/2 - 3/4	16	15.5	4	22.7	105
TMCC2020-4-29-11.5NPT	11.5	1 - 2	20	20.0	4	29.8	105
TMCC2020-4-39-8NPT	8	≥ 2 1/2	20	20.0	4	39.7	105

Für Vorbearbeitung siehe konische VHM-Schaftfräser siehe Seite 168 | For conical preparation end mills see page 168

NPT

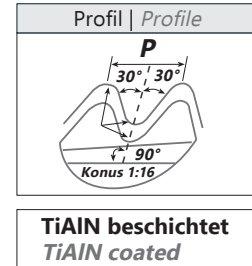
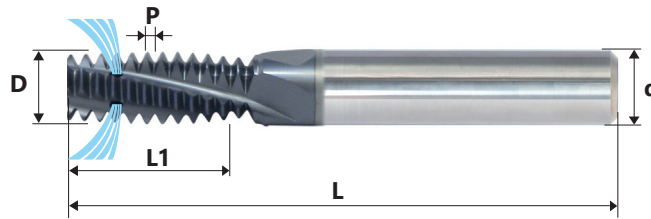

Innere Kühlmittelzufuhr mit Nutenaustritt - gleiches Werkzeug für Innen- und Außengewinde
with internal coolant supply through the flutes - same tool for internal and external threads

Artikelnummer (Item Number)	Steigung (Pitch) P in TPI	Standard	d in mm	D in mm	Schneiden (Flutes)	L1 in mm	L in mm
TMCF08076-3-10-27NPT	27	1/8	8	7.6	3	10.8	64
TMCF1010-4-16-18NPT	18	1/4 - 3/8	10	10.0	4	16.2	73
TMCF16155-4-22-14NPT	14	1/2 - 3/4	16	15.5	4	22.7	101

Für Vorbearbeitung siehe konische VHM-Schaftfräser siehe Seite 168 | For conical preparation end mills see page 168

NPTF

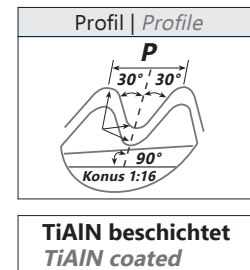
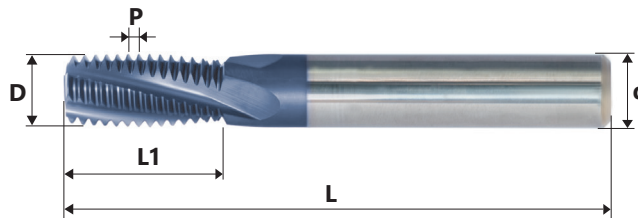

gleiches Werkzeug für Innen- und Außengewinde
same tool for internal and external threads

Artikelnummer (Item Number)	Steigung (Pitch) P in TPI	Standard	d in mm	D in mm	Schneiden (Flutes)	L1 in mm	L in mm
TMC0606-3-9-27NPTF	27	1/16 - 1/8	6	6.0	3	9.9	58
TMC0808-3-14-18NPTF	18	1/4 - 3/8	8	8.0	3	14.8	64
TMC1212-4-20-14NPTF	14	1/2 - 3/4	12	12.0	4	20.9	84
TMC1616-4-27-11.5NPTF	11.5	1 - 2	16	16.0	4	27.6	105
TMC2020-4-39-8NPTF	8	≥ 2 1/2	20	20.0	4	39.7	105

Für VHM-Gewindefräser mit Innenkühlung siehe nächste Seiten | For thread mills with coolant see following pages
Für Vorbearbeitung siehe konische VHM-Schaftfräser siehe Seite 168 | For conical preparation end mills see page 168

NPTF

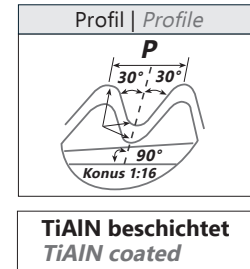
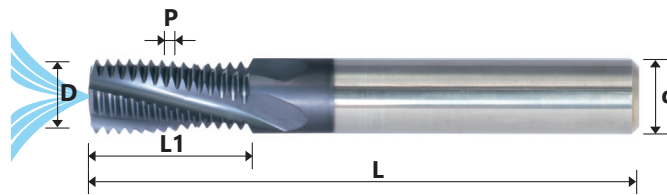

mit Innenkühlung - gleiches Werkzeug für Innen- und Außengewinde
with internal coolant bore - same tool for internal and external threads

Artikelnummer (Item Number)	Steigung (Pitch) P in TPI	Standard	d in mm	D in mm	Schneiden (Flutes)	L1 in mm	L in mm
TMCC08076-3-10-27NPTF	27	1/8	8	7.6	3	10.8	64
TMCC1010-4-16-18NPTF	18	1/4 - 3/8	10	10.0	4	16.2	73
TMCC16155-4-22-14NPTF	14	1/2 - 3/4	16	15.5	4	22.7	105
TMCC2020-4-29-11.5NPTF	11.5	1 - 2	20	20.0	4	29.8	105
TMCC2020-4-39-8NPTF	8	≥ 2 1/2	20	20.0	4	39.7	105

Für Vorbearbeitung siehe konische VHM-Schaftfräser siehe Seite 168 | For conical preparation end mills see page 168

NPTF

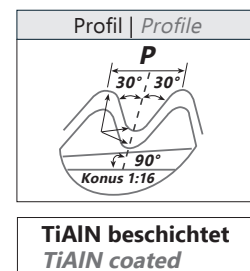
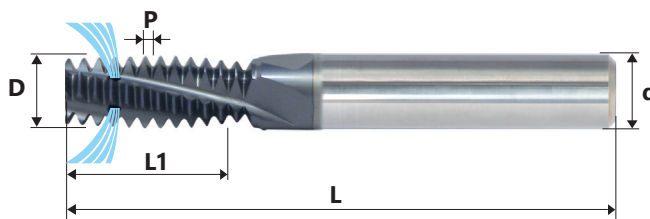

innere Kühlmittelzufuhr mit Nutenaustritt - gleiches Werkzeug für Innen- und Außengewinde
with internal coolant through the flutes - same tool for internal and external threads

Artikelnummer (Item Number)	Steigung (Pitch) P in TPI	Standard	d in mm	D in mm	Schneiden (Flutes)	L1 in mm	L in mm
TMCF08076-3-10-27NPTF	27	1/8	8	7.6	3	10.8	64
TMCF1010-4-16-18NPTF	18	1/4 - 3/8	10	10.0	4	16.2	73
TMCF16155-4-22-14NPTF	14	1/2 - 3/4	16	15.5	4	22.7	101

Für Vorbearbeitung siehe konische VHM-Schaftfräser siehe Seite 168 | For conical preparation end mills see page 168

NPS

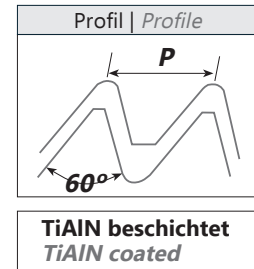
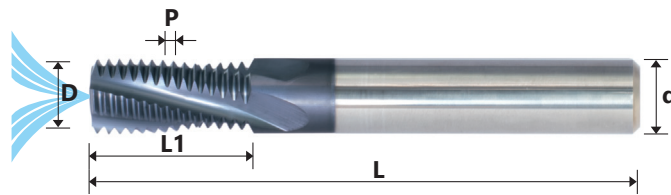

mit Innenkühlung - gleiches Werkzeug für Innen- und Außengewinde
with internal coolant bore - same tool for internal and external threads

Artikelnummer (Item Number)	Steigung (Pitch) P in TPI	Standard	d in mm	D in mm	Schneiden (Flutes)	L1 in mm	L in mm
TMCC0312-3-04-27NPS	27	1/8	5/16	7.6	3	10.8	63
TMCC0375-4-06-18NPS	18	1/4 - 3/8	3/8	9.5	4	16.2	76
TMCC0625-4-08-14NPS	14	1/2 - 3/4	5/8	15.5	4	22.7	101
TMCC0750-4-11-11.5NPS	11.5	1 - 2	3/4	19.0	4	29.8	101

NPSF

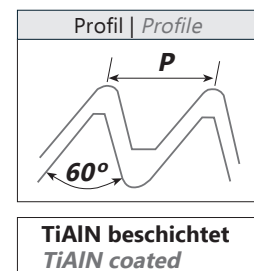
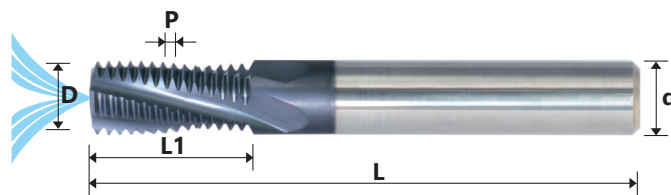

mit Innenkühlung - gleiches Werkzeug für Innen- und Außengewinde
with internal coolant bore - same tool for internal and external threads

Artikelnummer (Item Number)	Steigung (Pitch) P in TPI	Standard	d in mm	D in mm	Schneiden (Flutes)	L1 in mm	L in mm
TMCC0312-3-04-27NPSF	27	1/8	5/16	7.6	3	10.8	63
TMCC0375-4-06-18NPSF	18	1/4 - 3/8	3/8	9.5	4	16.2	76
TMCC0625-4-08-14NPSF	14	1/2 - 3/4	5/8	15.5	4	22.7	101
TMCC0750-4-11-11.5NPSF	11.5	1 - 2	3/4	19.0	4	29.8	101

PG DIN 40430

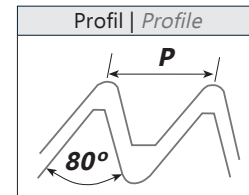
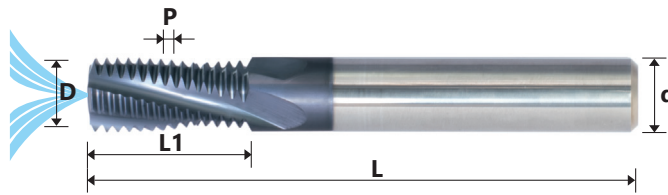

TiAlN beschichtet
TiAlN coated

mit Innenkühlung - gleiches Werkzeug für Innen- und Außengewinde
with internal coolant bore - same tool for internal and external threads

Artikelnummer (Item Number)	Steigung (Pitch) P in TPI	Standard	d in mm	D in mm	Schneiden (Flutes)	L1 in mm	L in mm
TMCC1010-4-19-20PG	20	Pg 7	10	10.0	4	19.7	73
TMCC1212-4-20-18PG	18	Pg 9, 11, 13.5, 16	12	12.0	4	20.5	84
TMCC1212-4-23-16PG	16	Pg 21, 29, 36, 42, 48	12	12.0	4	23.0	84

TEST REPORT

Innengewinde Internal thread	M10 x 1
Gewindetiefe Thread depth	10.0 mm
Werkstoff Material	34CrNiMo6 (1.6582)
Werkzeug Tool	Halter Holder: TMCC 0606-3-12-1.0 ISO Platte Insert: 21IN3.0ISO
Schnittgeschwindigkeit Cutting speed	Vc: 100 m/min Fz: 0.02 mm/Z
Kühlung Coolant	Emulsion
Standzeit Tool life	758 Platten Pieces

ISO

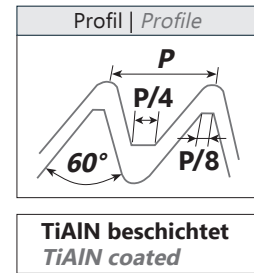
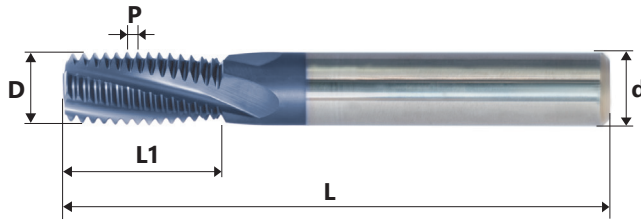

ohne Innenkühlung - nur für Außengewinde
without internal coolant bore - for external threads

Artikelnummer (Item Number)	Steigung (Pitch) in mm	d in mm	D in mm	Anzahl der Schneiden (No. of Flutes)	L1 in mm	L in mm
EXTMC1010-4-16-1.0ISO	1.0	10	10.0	4	16.5	73
EXTMC1212-5-20-1.0ISO	1.0	12	12.0	5	20.5	84
EXTMC1010-4-16-1.25ISO	1.25	10	10.0	4	16.9	73
EXTMC1010-4-15-1.5ISO	1.5	10	10.0	4	15.8	73
EXTMC1212-4-20-1.5ISO	1.5	12	12.0	4	20.3	84
EXTMC1212-4-20-1.75ISO	1.75	12	12.0	4	20.1	84
EXTMC1010-3-17-2.0ISO	2.0	10	10.0	3	17.0	73
EXTMC1212-4-21-2.0ISO	2.0	12	12.0	4	21.0	84

UN

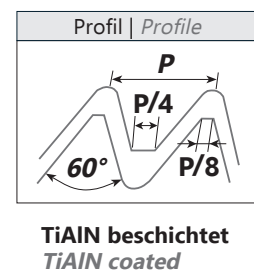
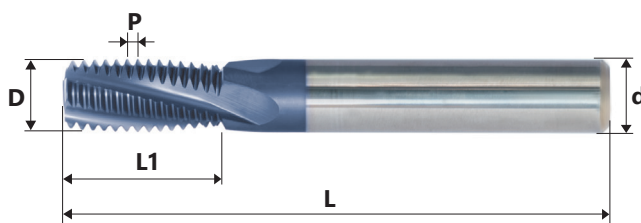

ohne Innenkühlung - nur für Außengewinde
without internal coolant bore - for external threads

Artikelnummer (Item Number)	Steigung (Pitch) in mm	d in mm	D in mm	Anzahl der Schneiden (No. of Flutes)	L1 in mm	L in mm
EXTMC1010-4-16-24UN	24	10	10.0	4	16.4	73
EXTMV1212-5-21-20UN	20	12	12.0	5	21.0	84
EXTMC1212-4-20-18UN	18	12	12.0	4	20.5	84
EXTMC1212-4-21-16UN	16	12	12.0	4	21.4	84
EXTMC1212-4-20-14UN	14	12	12.0	4	20.9	84
EXTMC1212-4-20-12UN	12	12	12.0	4	20.1	84

KONISCHE VHM-SCHAFTFRÄSER

TAPERED SOLIDE CARBIDE END MILLS

Konische VHM-Schaftfräser ermöglichen die Vorbearbeitung von konischen Gewinden.
 Solid carbide tapered end mills are used for milling preparation of conical threads before the thread milling operation.

VORTEILE

- Verlängert die Standzeit der Gewindefräswerkzeuge
- Gleichmäßiger Schnittdruck bei der Gewindebearbeitung
- Kürzere Maschinenzeit durch konisch vorbereitete Kerndurchmesser oder Außendurchmesser

ADVANTAGES:

- increases tool life of thread milling cutters and indexable inserts
- equal and uniform load along the cutting edge of the thread milling cutter
- shorter machining time of the thread milling operation, due to the tapered preparation

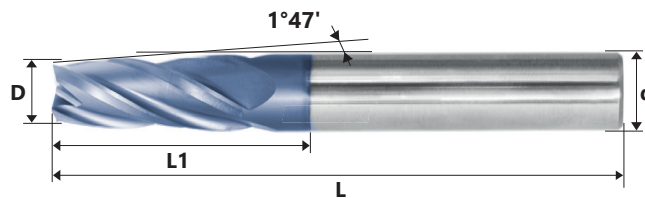

TiAlN beschichtet
 TiAlN coated

Artikelnummer (Item Number)	Größe (Size)	D in mm	d in mm	Schneiden (Flutes)	L1 in mm	L in mm
CC0652-4-12	NPT 1/16" - 1/8"	5.2	6	4	12	58
	NPTF 1/16" - 1/8"					
	BSPT 1/16" - 1/8"					
CC1085-4-24	NPT 1/8" - 1"	8.5	10	4	24	73
	NPTF 1/8" - 1"					
	BSPT 1/8" - 1"					
CC1210-4-32	NPT 1/4" - 3"	10.0	12	4	32	84
	NPTF 1/4" - 3"					
	BSPT 1/4" - 3"					

AUSSENBEARBEITUNG

EXTERNAL MACHINING

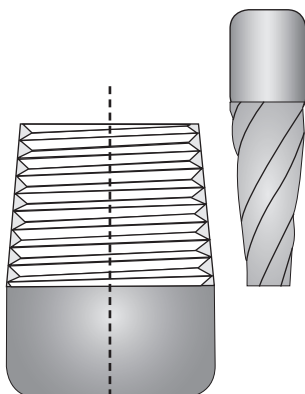

INNENBEARBEITUNG

INTERNAL MACHINING

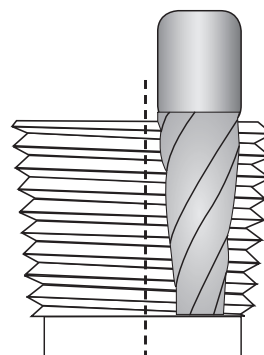

10 MINI-GEWINDEFÄHRER

MINI THREAD MILLS

VORTEILE

- das gleiche Werkzeug f#r eine Vielzahl von Gewinden und Steigungen
- Spiralnuten erlauben einen weichen Schnitt
- das gleiche Werkzeug f#r Innen und Au#engewinde
- k#rzere Bearbeitungszeit durch mehrere Schneiden (3-5)
- gro#e Auskragl#nge
- Gewinde bis max. 5xD m#glich
- geringer Schnittdruck durch spezielle Schneidengeometrie

ADVANTAGES:

- *same tool can produce a wide range of threads and pitches*
- *spiral flutes allows smooth cutting operation*
- *same tool can produce both external & internal threads*
- *shorter machining time due to 3 to 6 simultaneously engaged cutting edges*
- *enables machining of deep holes*
- *thread length up to 5xD*
- *low cutting forces thanks to a special cutting edge profile*

TMCM

- Gewinde ab M1x0.25 und 0-80UN | *threads starting from ISO M1 x 0.25 and 0.08UN*
- hohe Schnittgeschwindigkeit | *high cutting speed*
- kurze Bearbeitungszeit | *short machining time*
- Fr#sen von hochverg#teten Material m#glich bis 45 HRC
machining of hardened materials up to 45 HRC

HARTMETALLSORTE | COATING TIALN

Titan-Aluminum-Nitrid-Mehrfachbeschichtung (ISO K10 - K20), bei mittlerer und hoher Schnittgeschwindigkeit einsetzbar, generell f#r alle Werkstoffe.

Titanium Aluminum Nitride multy-layer coating (ISO K10 - K20). To be run at medium to high cutting speeds. General purpose for all materials.

THREAD MILLING

PRODUKT BEZEICHNUNG | PRODUCT DESIGNATION

BEISPIEL | EXAMPLE: TMCM0603-3-39-0.7ISO-L

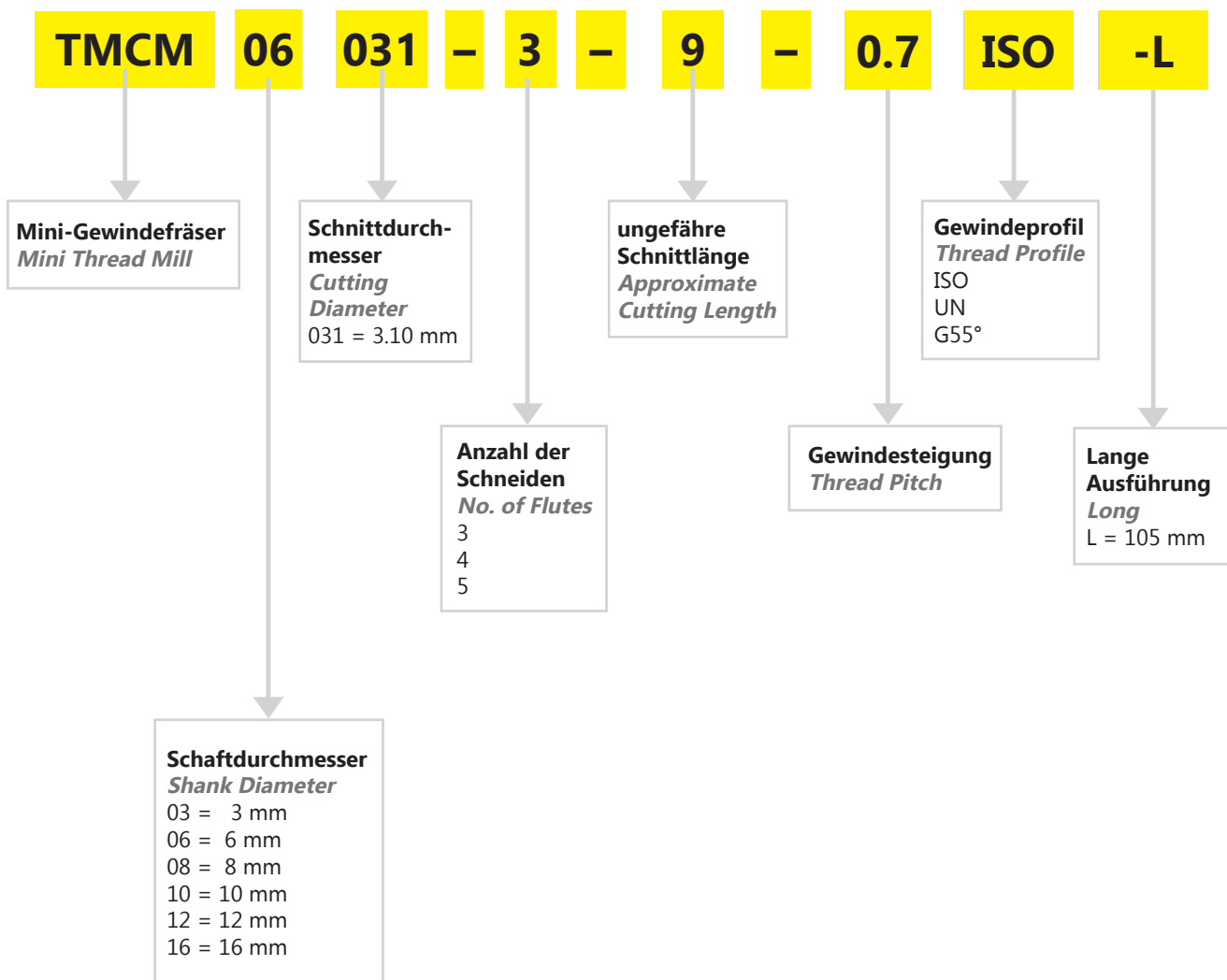

THREAD MILLING

PRODUKT BEZEICHNUNG | PRODUCT DESIGNATION

BEISPIEL | EXAMPLE: TMCMI03009-3-3-0.25ISO

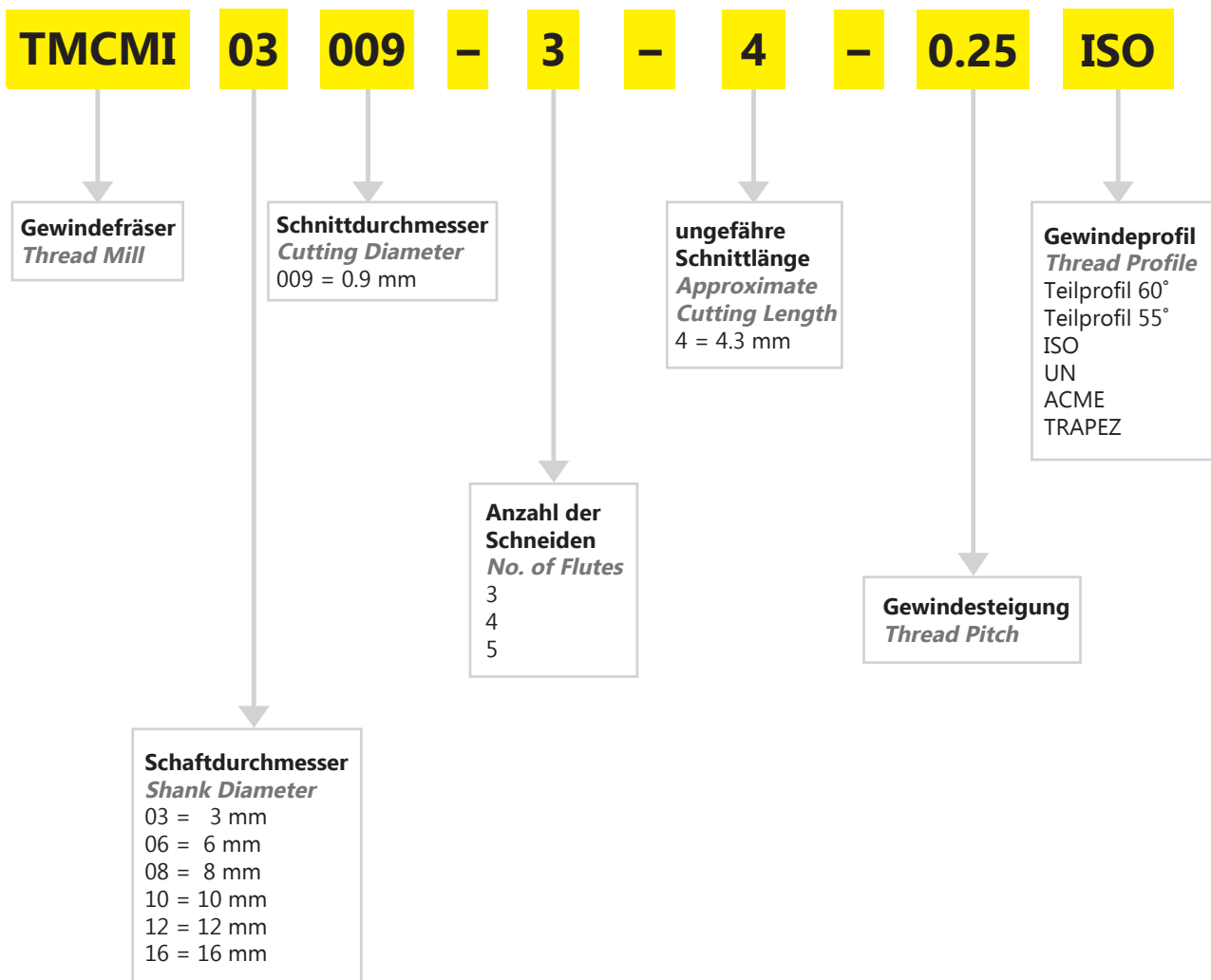

ISO

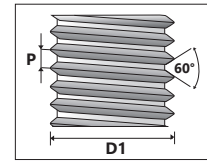
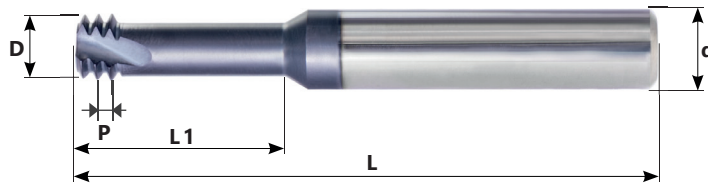

TiAlN beschichtet
TiAlN coated

Mini VHM-Gewindefräser ISO | Mini Thread Mill ISO
bis zu einer Gewindetiefe von 2 x D1 | for thread depth up to 2 x D1

Artikelnummer (Item Number)	Maße (mm) Dimensions (mm)						Schneiden (Flutes)
	P	L	D1	d	D	L1	
TMCM03007-3-2-0.25ISO	0,25	39	M1	3	0,72	2,5	3
TMCM03009-3-3-0.25ISO	0,25	39	M1,2	3	0,90	3,0	3
TMCM06045-4-14-0.35ISO	0,35	58	M5	6	4,50	14,5	4
TMCM06016-3-4-0.4ISO	0,4	58	M2	6	1,53	4,5	3
TMCM06016-3-4-0.4ISO-L*	0,4	105	M2	6	1,53	4,5	3
TMCM06017-3-5-0.45ISO	0,45	58	M2,2	6	1,65	5,0	3
TMCM0602-3-5-0.45ISO	0,45	58	M2,5	6	1,95	5,5	3
TMCM0602-3-5-0.45ISO-L*	0,45	105	M2,5	6	1,95	5,5	3
TMCM06024-3-6-0.5ISO	0,5	58	M3	6	2,37	6,5	3
TMCM06024-3-6-0.5ISO-L*	0,5	105	M3	6	2,37	6,5	3
TMCM06028-3-70.6ISO	0,6	58	M3,5	6	2,75	7,5	3
TMCM06031-3-9-0.7ISO	0,7	58	M4	6	3,10	9,0	3
TMCM0808-4-25-0.75ISO	0,75	64	M10	8	8,00	25,0	4
TMCM06038-3-12-0.8ISO	0,8	58	M5	6	3,80	12,5	3
TMCM06047-3-14-1.0ISO	1,0	58	M6	6	4,65	14,0	3
TMCM0606-3-18-1.25ISO	1,25	58	M8	6	6,00	18,0	3
TMCM08078-3-23-1.5ISO	1,5	64	M10	8	7,80	23,0	3
TMCM1009-3-26-1.75ISO	1,75	73	M12	10	9,00	26,0	3
TMCM12118-4-35-2.0ISO	2,0	84	M16	12	11,80	35,0	4
TMCM1615-5-43-2.5ISO	2,5	105	M20	16	15,00	43,0	5

L* Lange Ausführung | long

ISO

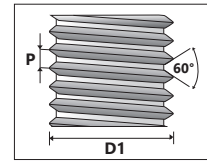
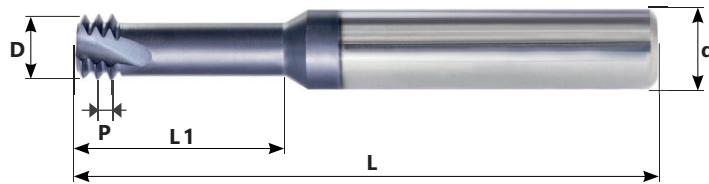

TiAlN beschichtet
TiAlN coated

Mini VHM-Gewindefräser ISO | Mini Thread Mill ISO
bis zu einer Gewindetiefe von 3 x D1 | for thread depth up to 3 x D1

Artikelnummer (Item Number)	Maße (mm) Dimensions (mm)						Schneiden (Flutes)
	P	L	D1	d	D	L1	
TMCM03011-3-4-0.3ISO	*0.3	39	M1.4	3	1.05	4.0	3
TMCM03012-3-5-0.35ISO	*0.35	39	M1.6	3	1.20	4.8	3
TMCM06012-3-5-0.35ISO-L*	0.35	105	M1.6	6	1.20	4.8	3
TMCM06045-4-14-0.35ISO	0.35	58	M5	6	4.50	14.5	4
TMCM03016-3-6-0.4ISO	*0.4	39	M2	3	1.53	6.0	3
TMCM03017-3-7-0.45ISO	*0.45	39	M2.2	3	1.65	7.0	3
TMCM0602-3-7-0.45ISO	0.45	58	M2.5	6	1.95	7.5	3
TMCM0602-3-8-0.45ISO-L*	0.45	105	M2.5	6	1.95	8.0	3
TMCM06024-3-9-0.5ISO	0.5	58	M3	6	2.37	9.5	3
TMCM06024-3-9-0.5ISO-L*	0.5	105	M3	6	2.37	9.5	3
TMCM06054-4-20-0.5ISO	0.5	58	M6, M7	6	5.35	20.0	4
TMCM06028-3-10-0.6ISO	0.6	58	M3.5	6	2.75	10.5	3
TMCM06031-3-12-0.7ISO	0.7	58	M4	6	3.10	12.5	3
TMCM06031-3-12-0.7ISO-L*	0.7	105	M4	6	3.10	12.5	3
TMCM06038-3-16-0.8ISO	0.8	58	M5	6	3.80	16.0	3
TMCM06038-3-16-0.8ISO-L*	0.8	105	M5	6	3.80	16.0	3
TMCM06047-3-20-1.0ISO	1.0	58	M6	6	4.65	20.0	3
TMCM06047-3-20-1.0ISO-L*	1.0	105	M6	6	4.65	20.0	3
TMCM0808-4-31-1.0ISO	1.0	64	M10	8	8.00	31.0	4
TMCM0606-3-24-1.25ISO	1.25	58	M8	6	6.00	24.0	3
TMCM0606-3-24-1.25ISO-L*	1.25	105	M8	6	6.00	24.0	3
TMCM08078-3-31-1.5ISO	1.5	64	M10	8	7.80	31.5	3
TMCM08078-3-31-1.5ISO-L*	1.5	105	M10	8	7.80	31.5	3
TMCM1009-3-37-1.75ISO	1.75	73	M12	10	9.00	37.8	3
TMCM12118-4-50-2.00ISO	2.0	105	M16	12	11.80	50.0	4

L* Lange Ausführung | long

ISO

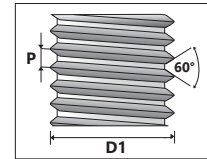
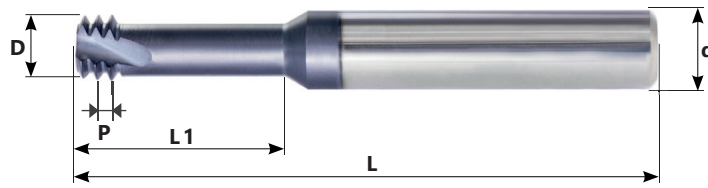

TiAlN beschichtet
TiAlN coated

Werkzeuge zur Herstellung von Innengewinde | tools for internal thread
bis zu einer Gewindetiefe von 4 x D1 | for thread depth up to 4 x D1

Artikelnummer (Item Number)	Maße (mm) (Dimensions mm)						Schneiden (Flutes)
	P	L	D1	d	D	L1	
TMCM0302-3-10-0.45ISO	0.45	39	M2.5	3	1.95	10.5	3
TMCM03024-3-12-0.5ISO	0.5	39	M3	3	2.40	12.5	3
TMCM06031-3-16-0.7ISO	0.7	58	M4	6	3.10	16.7	3
TMCM0604-3-20-0.8ISO	0.8	58	M5	6	4.00	20.8	3
TMCM06048-3-25-1.0ISO	1.0	58	M6	6	4.80	25.0	3

Bis zu einer Gewindetiefe von 5 x D1 | For thread depth up to 5 x D1

Artikelnummer (Item Number)	Maße (mm) (Dimensions mm)						Schneiden (Flutes)
	P	L	D1	d	D	L1	
TMCM03024-3-15-0.5ISO	0.5	39	M3	3	2.40	15.5	3

UN

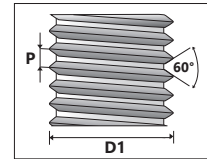
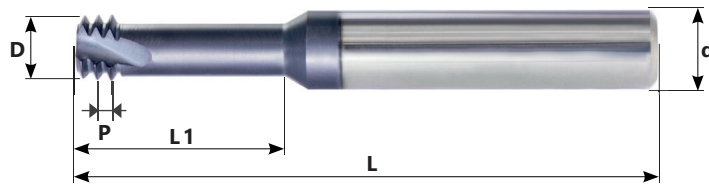

TiAlN beschichtet
TiAlN coated

Mini VHM-Gewindefräser UN | Mini Thread Mill UN
bis zu einer Gewindetiefe von 2 x D1 | for thread depth up to 2 x D1

Artikelnummer (Item Number)	UNC	UNF	Gänge/Zoll (TPJ) P	Maße (mm) (Dimensions mm)				Schneiden (Flutes)
				L	d	D	L1	
TMCM06014-3-3-72UN		1	72	58	6	1.45	3.7	3
TMCM06014-3-3-64UN	1	2	64	58	6	1.40	3.8	3
TMCM03016-3-4-56UN	2	3	56	39	3	1.65	4.4	3
TMCM06016-3-4-56UN	2	3	56	58	6	1.65	4.4	3
TMCM06019-3-548UN	3	4	48	58	6	1.90	5.2	3
TMCM06021-3-6-40UN	4		40	58	6	2.10	6.3	3
TMCM06021-3-6-40UN-L*	4		40	105	6	2.10	6.3	3
TMCM06024-3-7-40UN	5	6	40	58	6	2.45	7.0	3
TMCM06033-3-9-36UN		8	36	58	6	3.30	9.0	3
TMCM06025-3-7-32UN	6		32	58	6	2.55	7.1	3
TMCM06025-3-7-32UN-L*	6		32	105	6	2.55	7.1	3
TMCM06032-3-9-32UN	8		32	58	6	3.20	9.5	3
TMCM06032-3-9-32UN-L*	8		32	105	6	3.20	9.5	3
TMCM06037-3-10-32UN		10	32	58	6	3.70	10.5	3
TMCM06042-3-11-28UN		12	28	58	6	4.20	11.0	3
TMCM0605-3-14-28UN		1/4	28	58	6	5.00	14.5	3
TMCM06035-3-10-24UN	10,12		24	58	6	3.50	10.6	3
TMCM08066-3-17-24UN		5/16,3/8	24	64	8	6.60	17.0	3
TMCM06047-3-14-20UN	1/4		20	58	6	4.75	14.0	3
TMCM06047-3-14-20UN-L*	1/4		20	105	6	4.75	25.0	3
TMCM0808-3-25-20UN		7/16	20	64	8	8.00	25.0	3
TMCM0606-3-17-18UN	5/16		18	58	6	6.00	17.0	3
TMCM1212-4-35-18UN		5/8	18	84	12	12.00	35.0	4
TMCM08067-3-22-16UN	3/8		16	64	8	6.70	22.0	3
TMCM08077-3-25-14UN	7/16		14	64	8	7.70	25.0	3
TMCM10092-3-27-13UN	1/2		13	73	10	9.20	27.5	3
TMCM12105-3-31-12UN	9/16		12	84	12	10.50	31.5	3
TMCM12114-3-34-11UN	5/8		11	84	12	11.40	34.5	3
TMCM16144-4-41-10UN	3/4		10	105	16	14.40	41.5	4

L* Lange Ausführung | long

UN

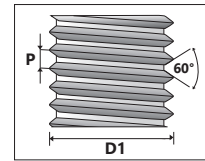
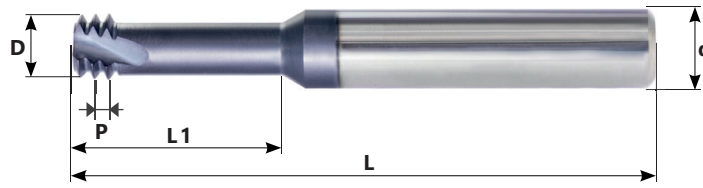

TiAlN beschichtet
TiAlN coated

Mini VHM-Gewindefräser UN | Mini Thread Mill UN
bis zu einer Gewindetiefe von 3 x D1 | for thread depth up to 3 x D1

Artikelnummer (Item Number)	UNC	UNF	Gänge/Zoll (TPI) P	Maße (mm) (Dimensions mm)				Schneiden (Flutes)
				L	d	D	L1	
TMCM06012-3-4-80UN		0	80	58	6	1.15	4.0	3
TMCM03015-3-6-72UN		1	*72	39	3	1.45	6.0	3
TMCM06014-3-364UN	1	2	64	58	6	1.40	3.8	3
TMCM03016-3-6-56UN	2	3	56	39	3	1.65	6.6	3
TMCM06016-3-6-56UN	2	3	56	58	6	1.65	6.6	3
TMCM06016-3-6-56UN-L*	2	3	56	105	6	1.65	6.6	3
TMCM03021-3-8-40UN	4		40	39	3	2.10	8.0	3
TMCM06021-3-8-40UN	4		40	58	6	2.10	8.0	3
TMCM06021-3-8-40UN-L*	4		40	105	6	2.10	8.0	3
TMCM06024-3-9-40UN	5	6	40	58	6	2.45	9.6	3
TMCM03025-3-10-32UN	6		32	39	3	2.55	10.5	3
TMCM06025-3-10-32UN	6		32	58	6	2.55	10.5	3
TMCM06025-3-10-32UN-L*	6		32	105	6	2.55	10.5	3
TMCM06032-3-12-32UN	8		32	58	6	3.20	12.5	3
TMCM06032-3-12-32UN-L*	8		32	105	6	3.20	12.5	3
TMCM06037-3-15-32UN		10	32	58	6	3.70	15.0	3
TMCM06037-3-15-32UN-L*		10	32	105	6	3.70	15.0	3
TMCM0605-3-19-28UN		1/4	28	58	6	5.00	19.0	3
TMCM0605-3-19-28UN-L*	1/4		28	105	6	5.00	19.0	3
TMCM06035-3-15-24UN	10,12		24	58	6	3.50	15.5	3
TMCM08066-3-24-24UN		5/16, 3/8	24	64	8	6.60	24.0	3
TMCM06047-3-19-20UN	1/4		20	58	6	4.75	19.0	3
TMCM06047-3-19-20UN-L*	1/4		20	105	6	4.75	19.0	3
TMCM0808-3-34-20UN		7/16	20	64	8	8.00	34.6	3
TMCM0606-3-23-18UN	5/16		18	58	6	6.00	23.0	3
TMCM1212-4-49-18UN		5/8	18	105	12	12.00	49.0	4
TMCM08067-3-30-16UN	3/8		16	64	8	6.70	30.2	3
TMCM08077-3-35-14UN	7/16		14	64	8	7.70	35.2	3
TMCM10092-3-40-13UN	1/2		13	73	10	9.20	27.5	3
TMCM12105-3-45-12UN	9/16		12	105	12	10.50	45.0	3
TMCM12114-3-50-11UN	5/8		11	105	12	11.40	50.0	3
TMCM16144-4-59-10UN	3/4		10	105	16	14.40	59.7	4

- * Speziell für die Herstellung von Zahnimplantaten entwickelt | Specially designed for production of dental implants
- Bearbeitung möglich in Titan, Edelstahl aller Art, gehärtetes und vergütetes Material und NE-Metalle
- Passend für Hochgeschwindigkeitszentren (30.000 - 40.000 UPM) und für Bearbeitungszentren (6.000 UPM und mehr)
- Generell für alle Regel- und Feingewinde einsetzbar
- Machining Titanium, surgical stainless steels and hardened materials up to 45 HRC
- Suitable for high speed machining centers (30,000 - 40,000 RPM) and for standard machining centers (6,000 RPM and higher)
- Can also be used for general purpose machining of regular & fine threads

L* Lange Ausführung | long

UN

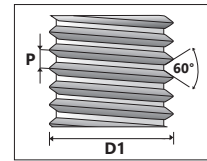
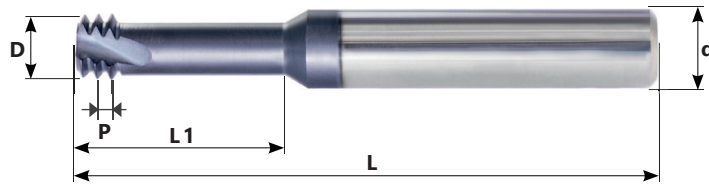

TiAlN beschichtet
TiAlN coated

Mini VHM-Gewindefräser UN | Mini Thread Mill UN
bis zu einer Gewindetiefe von 4 x D1 | for thread depth up to 4 x D1

Artikelnummer (Item Number)	UNC	UNF	Gänge/Zoll (TPI) p	Maße (mm) (Dimensions mm)				Schneiden (Flutes)
				L	d	D	L1	
TMCM03016-3-9-56UN	2	3	56	39	3	1.65	9.2	3
TMCM03021-3-12-40UN	4		40	39	3	2.10	12.0	3
TMCM03025-3-14-32UN	6		32	39	3	2.55	14.8	3
TMCM06032-3-17-32UN	8		32	58	6	3.20	17.5	3
TMCM06037-3-20-32UN		10	32	58	6	3.70	20.0	3

UN

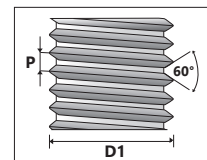
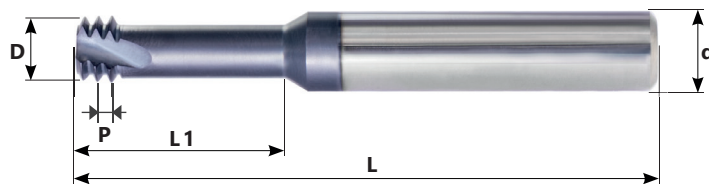

TiAlN beschichtet
TiAlN coated

Mini VHM-Gewindefräser UN | Mini Thread Mill UN
bis zu einer Gewindetiefe von 5 x D1 | for thread depth up to 5 x D1

Artikelnummer (Item Number)	UNC	UNF	Gänge/Zoll (TPI) p	Maße (mm) (Dimensions mm)				Schneiden (Flutes)
				L	d	D	L1	
TMCM03012-3-8-80UN		0	80	39	3	1.15	8.0	3
TMCM03016-3-11-56UN	2	3	56	39	3	1.65	11.4	3

G55°

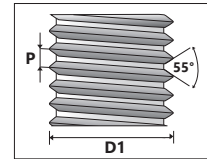
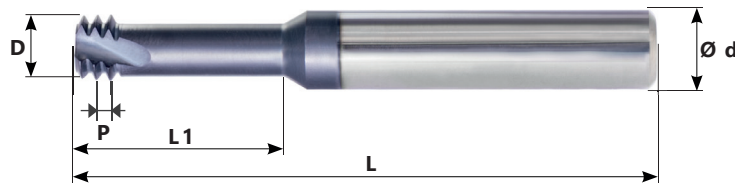

TiAlN beschichtet
TiAlN coated

gleiches Werkzeug für Innen- und Außengewinde | same Tool for internal and external thread

Artikelnummer (Item Number)	Gänge/Zoll (TPI) P	Standard	Maße (mm) Dimensions (mm)				Schneiden (Flutes)
			L	d	D	L1	
TMCM08078-3-19-28W	28	G 1/8	64	8	7.8	19.5	3
TMCM1010-4-30-19W	19	G 1/4 - 3/8	73	10	10.0	30.0	4
TMCM1212-4-37-14W	14	G 1/2 - 7/8	84	12	12.0	37.0	4
TMCM1616-4-44-11W	11	G ≥ 1	105	16	16.0	44.0	4

bis zu einer Gewindetiefe von 2 x D1 | for thread depth up to 2 x D1

TEILPROFIL 60° | PARTIAL PROFILE 60°

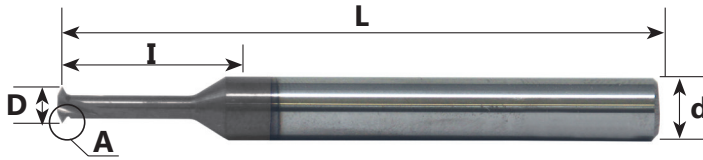

TiAlN beschichtet
TiAlN coated

gleiches Werkzeug für Innen- und Außengewinde | same Tool for internal and external thread

Artikelnummer (Item Number)	Steigung (Pitch) mm	Steigung Gänge/ Zoll (Pitch TPI)	M Coarse	M Fine	UN, UNC, UNS UNF, UNEF	d mm	D	Anzahl der Nuten (No. of Flutes)	I	L
TMCM103012-3-3-A60	0.25-0.35	100-72	M1.6 x 0.35	M1.6 x 0.25 M1.8 x 0.25 M2.0 x 0.25	0-80 UNF	3	1.15	3	3.1	39
TMCM103014-3-4-A60	0.35-0.45	72-56	M2 x 0.4 M2.2 x 0.45	M2 x 0.35 M2.2 x 0.35	1-64 UNC, 1-72 UNF, 2-56 UNC, 2-64 UNF	3	1.40	3	3.7	39
TMCM103019-3-5-A60	0.35-0.6	72-40	M2.5 x 0.45	M2.5 x 0.35 M3 x 0.35	3-84 UNC, 3-56 UNF, 4-40 UNC, 4-48 UNF	3	1.90	3	5.2	39
TMCM103024-3-7-A60	0.5-0.8	48-32	M3 x 0.5 M3.5 x 0.6	M3.5 x 0.5	5-40 UNC, 5-44 UNF, 6-32 UNC, 6-40 UNF	3	2.45	3	7.0	39
TMCM106032-3-9-A60	0.5-1.0	48-24	M4 x 0.7 M4.5 x 0.75	M4 x 0.5	8-32 UNC, 8-36 UNF, 10-24 UNC, 10-28 UNS, 10-32 UNF	6	3.20	3	9.5	58
TMCM10604-3-12-A60	0.5-1.0	48-24	M5 x 0.8 M6 x 1.0	M5 x 0.5 M5.5 x 0.5 M5 x 0.75	10-36 UNS, 10-40 UNS, 10-48 UNS, 12-24 UNC, 12-28 UNF	6	4.00	3	12.5	58

Hartmetal Qualität: Ultra-Feinstkorn-Hartmetall mit PVD-Dreilagenschichtung |
Carbide grade: Ultra-fine sub-micron grade with triple PVD coating

TEILPROFIL 60° | PARTIAL PROFILE 60°

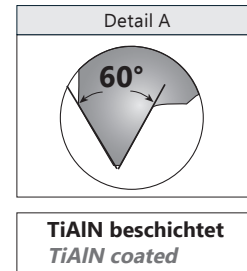
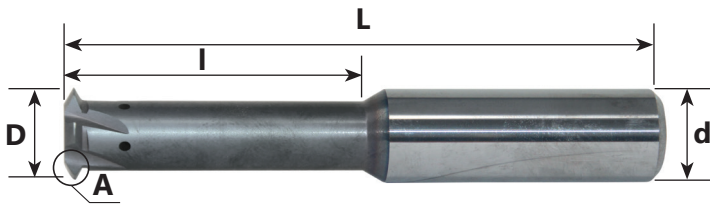

Innere Kühlmittelzufuhr mit Nutenaustritt, gleiches Werkzeug für Innen- & Außengewinde
 with internal coolant supply through the flutes, same tool for internal and external thread

Artikelnummer (Item Number)	Steigung (Pitch) mm	Steigung Gänge/Zoll (Pitch TPI)	Gewinde Ø (mm) (Thread Dia. mm)	d mm	D	Anzahl der Nuten (No. of Flutes)	I	L
TMCM10605-4-20-A60			Ø ≥ 6	6	5.0	4	20	58
TMCM10808-4-28-A60	Int. 0.5 - 0.8 Ex. 0.4 - 0.8	56-28 64-32	Ø ≥ 9	8	8.0	4	28	64
TMCM11212-5-38-A60			Ø ≥ 13	12	12.0	5	38	84
TMCM10808-4-30-A60	Int. 1.0 - 1.75 Ex. 0.8 - 1.5	28-14 32-16	Ø ≥ 10	8	8.0	4	30	64
TMCM11010-4-35-A60			Ø ≥ 12	10	10.0	4	35	73
TMCM11212-5-39-A60			Ø ≥ 14	12	12.0	5	39	84
TMCM11212-5-40-A60	Int. 2.0 - 3.0 Ex. 1.75-2.5	13- 8 15-10	Ø ≥ 16	12	12.0	5	40	84
TMCM11614-5-45-A60			Ø ≥ 18	16	14.0	5	45	101
TMCM11616-5-50-A60			Ø ≥ 20	16	16.0	5	50	101

Hartmetal Qualität: Feinstkorn Hartmetall mit einer Aluminium-Titan-Nitrit Mehrschichtenbeschichtung (ISO K10-K20). Sehr hohe Temperaturbeständigkeit und weiche Schnitte für hohe Schnittgeschwindigkeiten garantieren beste Standzeiten. Generell für alle Regel- und Feingewinde einsetzbar.

Carbide Grade: fine grain grade with multi-layer Titan Aluminium Nitride coating (ISO K10-K20). Very high heat resistance and smooth cutting at high speed guarantee the best tool life. For general machining of regular and fine threads.

TEILPROFIL 55° / PARTIAL PROFILE 55°

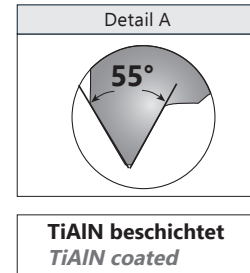
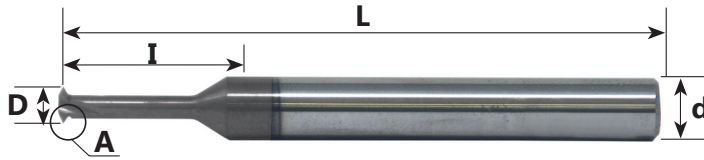

gleiches Werkzeug für Innen- und Außengewinde | same tool for internal and external thread

Artikelnummer (Item Number)	Steigung Gänge/Zoll (Pitch TPI)	d	D	Anzahl der Nuten (No. of Flutes)	I	L
TMCMI03023-3-7-A55	40-32	3	2.25	3	7.0	39
TMCMI06044-3-14-A55	28-20	6	4.35	3	14.0	58
TMCMI06059-3-20-A55	28-18	6	5.85	3	20.5	58
TMCMI0807-3-23-A55	20-14	8	7.00	3	23.0	64

Hartmetal Qualität: Ultra-Feinstkorn-Hartmetall mit PVD-Dreilagenschichtung
Carbide Grade: Ultra-fine Sub-micron grade with triple PVD coating

ISO

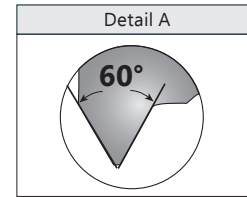
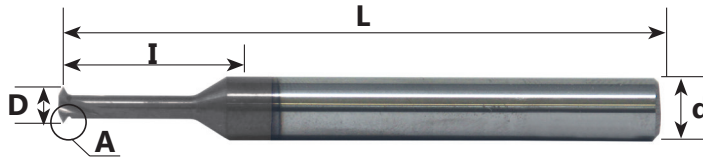

TiAlN beschichtet
TiAlN coated

Werkzeuge zur Herstellung von Innengewinden | tools for internal thread

Artikelnummer (Item Number)	Steigung (Pitch) mm	M Coarse	M Fine	d	D	Anzahl der Nuten (No. of Flutes)	I	L
TMCMIO3007-3-3-0.25ISO	0.25	M1 x 0.25		3	0.72	3	3.6	39
TMCMIO3009-3-4-0.25ISO	0.25	M1.2 x 0.25	M1.4 x 0.25 M1.6 x 0.25	3	0.90	3	4.3	39
TMCMIO3011-3-5-0.3ISO	0.3	M1.4 x 0.3		3	1.05	3	5.0	39
TMCMIO3012-3-6-0.35ISO	0.35	M1.6 x 0.35	M2 x 0.35 M2.2 x 0.35	3	1.20	3	5.7	39
TMCMIO3016-3-7-0.4ISO	0.4	M2 x 0.4		3	1.55	3	7.1	39
TMCMIO3024-3-10-0.5ISO	0.5	M3 x 0.5	M3.5 x 0.5 M4 x 0.5	3	2.37	3	10.6	39

für Gewindetiefe up to 3.5 x D1 | for thread depth up to 3.5 x D1

UN

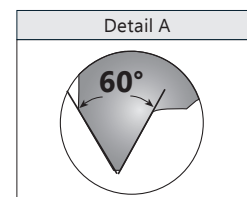
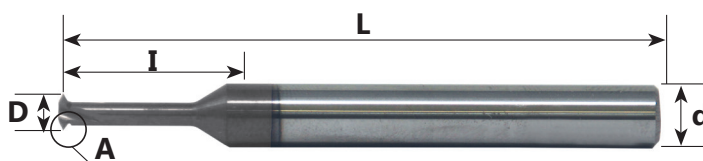

TiAlN beschichtet
TiAlN coated

Werkzeuge zur Herstellung von Innengewinden | tools for internal thread

Artikelnummer (Item Number)	Steigung (Pitch) mm	UNC	UNF	d	D	Anzahl der Nuten (No. of Flutes)	I	L
TMCMIO3012-3-5-80UN	80		0	3	1.15	3	5.5	39
TMCMIO3015-3-7-72UN	72		1	3	1.45	3	6.6	39
TMCMIO3016-3-9-56UN	56	2	3	3	1.65	3	8.9	39
TMCMIO3021-3-10-40UN	40	4		3	2.10	3	10.1	39

für Gewindetiefe up to 3.5 x D1 | for thread depth up to 3.5 x D1

TRAPEZ DIN 103

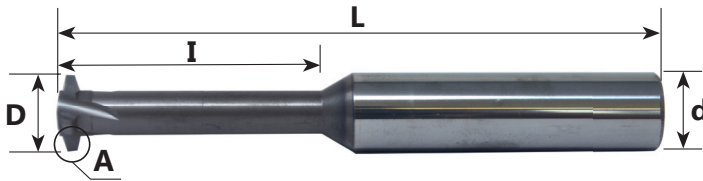

TiAlN beschichtet
TiAlN coated

Werkzeuge zur Herstellung von Innengewinden | tools for internal thread

Artikelnummer (Item Number)	Steigung (Pitch) mm	Gewindegröße Thread size	d	D	Anzahl der Nuten No. of Flutes	I	L
TMCMI06055-3-13-1.5TR	1.5	Tr8x1.5 Tr9x1.5	6	5.5	3	13.5	58
TMCMI08066-3-21-2TR	2	Tr10x2 Tr11x2	8	6.6	3	21.0	64
TMCMI10086-4-25-2TR	2	Tr12x2 Tr14x2	10	8.6	4	25.0	73
TMCMI0807-3-25-3TR	3	Tr12x3	8	7.0	3	25.0	64
TMCMI10089-4-29-3TR	3	Tr14x3 Tr22x3	10	8.9	4	29.0	73
TMCMI10092-3-33-4TR	4	Tr16x4 Tr18x4 Tr20x4	10	9.2	3	33.0	73
TMCMI14135-4-45-5TR	5	Tr22x5 Tr24x5 Tr26x5	14	13.5	4	45.0	105

für Gewindetiefe up to 2 x D1 | for thread depth up to 2 x D1



MINI GEWINDEFÄHRER FÜR GEHÄRTETE MATERIALIEN

11

MINI THREAD MILLS FOR HARDENED MATERIALS

FÜR GEHÄRTETE MATERIALIEN | FOR HARDENED MATERIALS

VORTEILE

- geringer Schnittdruck durch spezielle Schneidengeometrie
- perfekte Lösung für Werkzeug- und Formenbau
- Gewinde ab ISO M1.4 x 0.3 und 0-80UN
- Gewinde bis max. 2xD möglich
- kleinere Späne, welche die Prozesssicherheit erhöhen
- reduziert die Bearbeitungszeit
- hohe Schnittgeschwindigkeit
- verkürzte Bearbeitungszeit erhöht Ihre Produktivität
- Ultra-Feinstkorn Hartmetall speziell für gehärtete Materialien
- die Beschichtung gewährleistet eine höhere Abriebfestigkeit und Hitzebeständigkeit

ADVANTAGES:

- *lower cutting forces thanks to a special cutting edge geometry*
- *perfect solution for the Mold and Die Industry*
- *threading from ISO m1.4x0.3 and 0-80 UN*
- *thread length up to 2xD*
- *short chips increase safety*
- *short machining time*
- *machining at high cutting speeds*
- *short cycle time - increase a productivity*
- *ultra fine grade - special for hardened materials*
- *coating provides high wear and heat resistance*

TMCMH

Gewindefräser für die Bearbeitung von gehärteten Materialien bis 62 HRC. Diese Werkzeuge garantieren höchste Genauigkeit, einen weichen Schnitt und eine hervorragende Oberfläche.
Thread Mills designed specifically for machining of hardened materials up to 62HRC. These tools provide high performance, improved cut and excellent surface.

HARTMETALLSORTE TIALN | CARBIDE GRADE WITH TIALN COATING

Ultra-Feinstkorn Hartmetall mit einer speziellen PVD dreifach Beschichtung.
Ultra fine sub-micron grade with advanced triple PVD coating.

THREAD MILLING

PRODUKT BEZEICHNUNG | PRODUCT DESIGNATION

BEISPIEL | EXAMPLE: TMCH0631-3-9-0.7 ISO

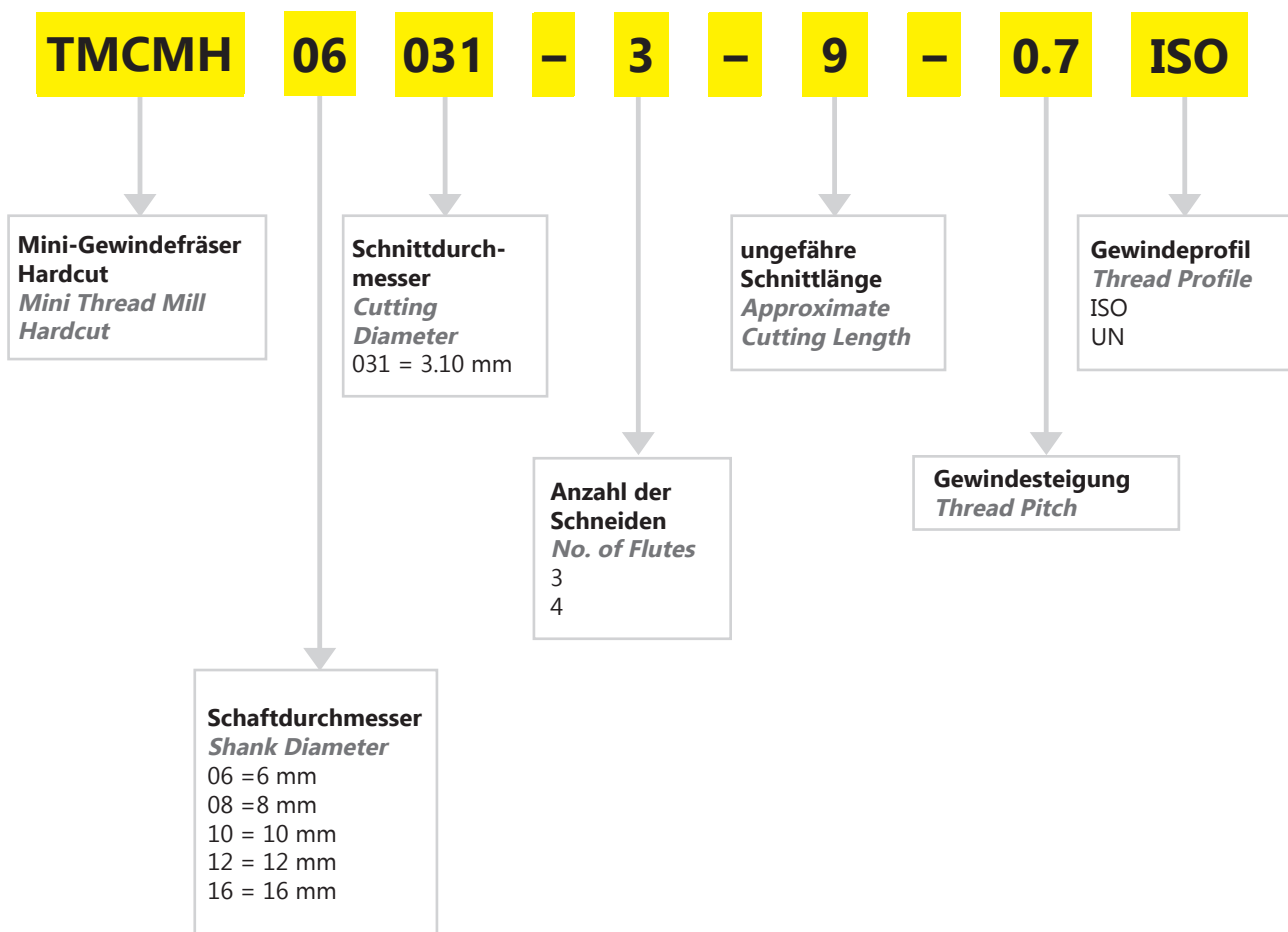

ISO

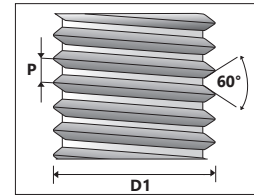
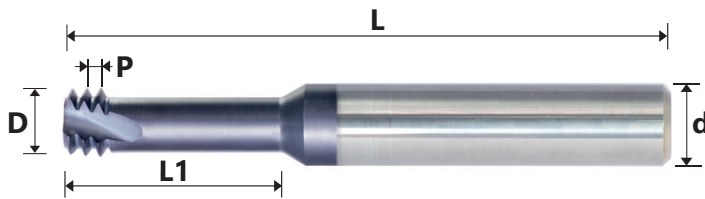

Linkslaufende
Spindeldrehrichtung
code M04
for left hand spindle
rotation use code M04

Werkzeuge zur Herstellung von Innengewinde | tools for internal thread
bis zu einer Gewindetiefe von 2 x D1 | for thread depth up to 2 x D1

Artikelnummer (Item Number)	P Steigung (Pitch) in mm	L in mm	d in mm	D1 in mm	D in mm	L1 in mm	Anz. der Schneiden (No. of Flutes)
TMCMH06016-3-4-0.4ISO	0.4	58	6	M2	1.53	4.5	3
TMCMH06017-3-5-0.45ISO	0.45	58	6	M2.2	1.65	5.0	3
TMCMH0602-3-5-0.45ISO	0.45	58	6	M2.5	1.95	5.5	3
TMCMH06024-3-6-0.5ISO	0.5	58	6	M3	2.37	6.5	3
TMCMH06028-3-7-0.6ISO	0.6	58	6	M3.5	2.75	7.5	3
TMCMH06031-3-9-0.7ISO	0.7	58	6	M4	3.10	9.0	3
TMCMH06038-3-12-0.8ISO	0.8	58	6	M5	3.80	12.5	3
TMCMH06047-3-14-1.0ISO	1.0	58	6	M6	4.65	14.0	3
TMCMH0606-3-18-1.25ISO	1.25	58	6	M8	6.00	18.0	3
TMCMH08078-3-23-1.5ISO	1.5	64	8	M10	7.80	23.0	3
TMCMH1009-3-26-1.75ISO	1.75	73	10	M12	9.00	26.0	3
TMCMH12118-4-35-2.0ISO	2.0	84	12	M16	11.80	35.0	4

Bestellbeispiel | Order example: TMCMH08078-3-23-1.5ISO TiAIN

bis zu einer Gewindetiefe von 3 x D1 | for thread depth up to 3 x D1

Artikelnummer (Item Number)	P Steigung (Pitch) in mm	L in mm	d in mm	D1 in mm	D in mm	L1 in mm	Anz. der Schneiden (No. of Flutes)
TMCMH03011-3-4-0.3ISO	0.3	39	3	M1.4	1.05	4.0	3
TMCMH03012-3-5-0.35ISO	0.35	39	3	M1.6	1.20	4.8	3
TMCMH03016-3-6-0.4ISO	0.4	39	3	M2	1.53	6.0	3
TMCMH06017-3-7-0.45ISO	0.45	58	6	M2.2	1.65	7.0	3
TMCMH0602-3-7-0.45ISO	0.45	58	6	M2.5	1.95	7.5	3
TMCMH06024-3-9-0.5ISO	0.5	58	6	M3	2.37	9.5	3
TMCMH06028-3-10-0.6ISO	0.6	58	6	M3.5	2.75	10.5	3
TMCMH06031-3-12-0.7ISO	0.7	58	6	M4	3.20	12.5	3
TMCMH06038-3-16-0.8ISO	0.8	58	6	M5	3.80	16.0	3
TMCMH06047-3-20-1.0ISO	1.0	58	6	M6	4.65	20.0	3
TMCMH0606-3-24-1.25ISO	1.25	58	6	M8	6.00	24.0	3

Bestellbeispiel | Order example: TMCMH08078-3-23-1.5ISO TiAIN

UN

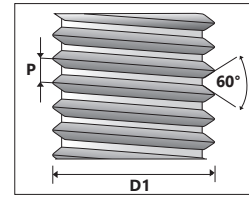
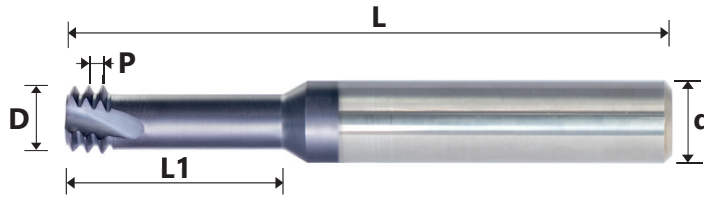

Linkslaufende
Spindeldrehrichtung
code M04
for left hand spindle
rotation use code M04

Werkzeuge zur Herstellung von Innengewinde | tools for internal thread
bis zu einer Gewindetiefe von 2 x D1 | for thread depth up to 2 x D1

Artikelnummer (Item Number)	P Steigung (Pitch) in TPI	L in mm	UNC	UNF	d in mm	D in mm	L1 in mm	Anz. der Schneiden (No. of Flutes)
TMCMH06014-3-3-72UN	72	58		1	6	1.45	3.7	3
TMCMH06014-3-3-64UN	64	58	1	2	6	1.40	3.8	3
TMCMH06016-3-4-56UN	56	58	2	3	6	1.65	4.4	3
TMCMH06019-3-5-48UN	48	58	3	4	6	1.90	5.2	3
TMCMH06021-3-6-40UN	40	58	4		6	2.10	6.3	3
TMCMH06024-3-7-40UN	40	58	5	6	6	2.45	7.0	3
TMCMH06033-3-9-36UN	36	58		8	6	3.30	9.0	3
TMCMH06025-3-7-32UN	32	58	6		6	2.55	7.1	3
TMCMH06032-3-9-32UN	32	58	8		6	3.20	9.5	3
TMCMH06037-3-10-32UN	32	58		10	6	3.70	10.5	3
TMCMH06042-3-11-28UN	28	58		12	6	4.20	11.0	3
TMCMH0605-3-14-28UN	28	58		1/4	6	5.00	14.5	3
TMCMH06035-3-10-24UN	24	58	10, 12		6	3.50	10.6	3
TMCMH08066-3-17-24UN	24	64		5/16, 3/8	8	6.60	17.0	3
TMCMH06047-3-14-20UN	20	58	1/4		6	4.75	14.0	3
TMCMH0808-3-25-20UN	20	64		7/16	8	8.00	25.0	3
TMCMH0606-3-17-18UN	18	58	5/16		6	6.00	17.0	3
TMCMH1212-4-35-18UN	18	84		5/8	12	12.00	35.0	4
TMCMH08067-3-22-16UN	16	64	3/8		8	6.70	22.0	3
TMCMH08077-3-25-14UN	14	64	7/16		8	7.70	25.0	3
TMCMH10092-3-27-13UN	13	73	1/2		10	9.20	27.5	3
TMCMH12105-3-31-12UN	12	84	9/16		12	10.50	31.5	3
TMCMH12114-3-34-11UN	11	84	5/8		12	11.40	34.5	3
TMCMH16144-4-41-10UN	10	105	3/4		16	14.40	41.5	4

Bestellbeispiel | Order example: TMCMH12114-3-34-11UNTAIN

UN

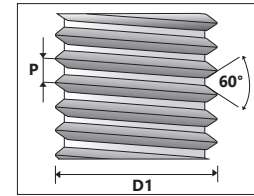
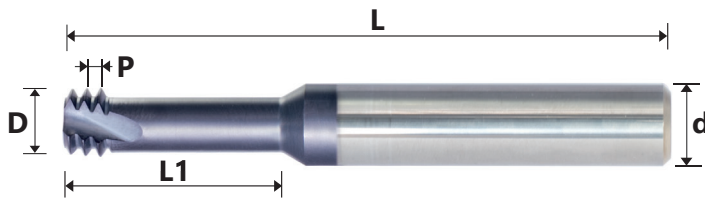

Linkslaufende
Spindeldrehrichtung
code M04
for left hand spindle
rotation use code M04

Werkzeuge zur Herstellung von Innengewinde | tools for internal thread
bis zu einer Gewindetiefe von 3 x D1 | for thread depth up to 3 x D1

Artikelnummer (Item Number)	P Steigung (Pitch) in TPI	L in mm	UNC	UNF	d in mm	D in mm	L1 in mm	Anz. der Schneiden (No. of Flutes)
TMCMH06012-3-4-80UN	80	58		0	6	1.15	4.0	3
TMCMH03015-3-6-72UN	72	39		1	3	1.45	6.0	3
TMCMH06016-3-6-56UN	56	58	2	3	6	1.65	6.6	3
TMCMH06021-3-8-40UN	40	58	4		6	2.10	8.0	3
TMCMH06024-3-9-40UN	40	58	5	6	6	2.45	9.6	3
TMCMH06025-3-10-32UN	32	58	6		6	2.55	10.5	3
TMCMH06032-3-12-32UN	32	58	8		6	3.20	12.5	3
TMCMH06037-3-15-32UN	32	58		10	6	3.70	15.0	3
TMCMH0605-3-19-28UN	28	58		1/4	6	5.00	19.0	3
TMCMH08066-3-24-24UN	24	64		5/16, 3/8	8	6.60	24.0	3
TMCMH06047-3-19-20UN	20	58	1/4		6	4.75	19.0	3
TMCMH0606-3-23-18UN	18	58	5/16		6	6.00	23.0	3

Bestellbeispiel | Order example: TMCMH06012-3-4-80UNTiAlN

MINI-GEWINDEFÄHRER TMCMH TYP

MINI THREAD MILL TMCMH TYPE

TiAlN Ultra-Feinstkorn Hartmetall mit einer speziellen PVD-dreifach-Beschichtung.
 Linkslaufende Spindeldrehrichtung code M04.

TiAlN Ultra-fine grain carbide grade with a special triple PVD coating.
 For left hand spindle rotation use code M04

ISO	Material	Härte Hardness HRC	Vc m/min	Vorschub Feed mm/tooth													
				ø1	ø1.5	ø2	ø3	ø4	ø5	ø6	ø7	ø8	ø9	ø10	ø12	ø14	ø16
S	Nickellegierung, Titanlegierung und Superlegierungen Nickel Alloys Titanium Alloys and High Temp. Alloys		20 - 40	0.03	0.03	0.03	0.04	0.04	0.05	0.06	0.06	0.06	0.07	0.07	0.07	0.08	0.08
H	Gehärteter Stahl Hardened Steels	45- 50	60- 70	0.03	0.04	0.04	0.05	0.05	0.06	0.06	0.07	0.07	0.08	0.08	0.09	0.10	0.11
		51 - 55	50 - 55	0.02	0.03	0.03	0.04	0.04	0.05	0.05	0.06	0.06	0.07	0.07	0.08	0.09	0.10
		56- 62	40- 50	0.01	0.02	0.02	0.03	0.03	0.04	0.04	0.05	0.05	0.06	0.06	0.07	0.08	0.09

TEST REPORT

Innengewinde Internal thread	M4 x 0.7
Gewindetiefe Thread depth	10.0 mm
Material	1.2379
Werkzeug Tool	TMCMH 06031-3-9-0.7 ISO
Schnittgeschwindigkeit Cutting speed	Vc: 4 m/min Fz: 0.03 mm/Z
Kühlung Coolant	Emulsion
Standzeit Tool life	84 Platten Pieces



12

GEWINDEFÄSEN TECHNISCHER TEIL
THREAD MILLING TECHNICAL SECTION

DIE UMRECHNUNG VON SCHNITTGESCHWINDIGKEIT IN DREHGESCHWINDIGKEIT (CONVERSION OF CUTTING SPEED TO ROTATIONAL SPEED):

Die Umrechnung der gewählten Schnittgeschwindigkeit in die Drehgeschwindigkeit erfolgt nach folgender Formel
(Conversion of selected cutting speed to rotational speed is calculated using the following formula):

$$N = \frac{V \times 1000}{\pi \times D} = \frac{120 \times 1000}{3.14 \times 30} = 1274 \text{ UPM}$$

Beispiel (Example): $V = 120 \text{ m/min}$
 $D = 30 \text{ mm}$

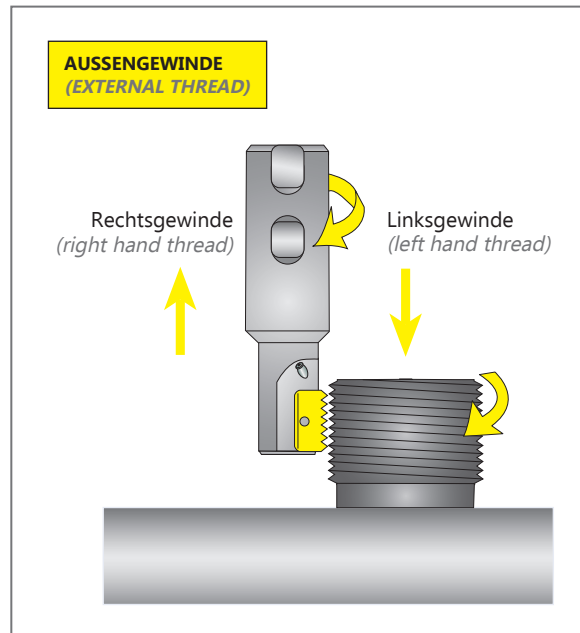
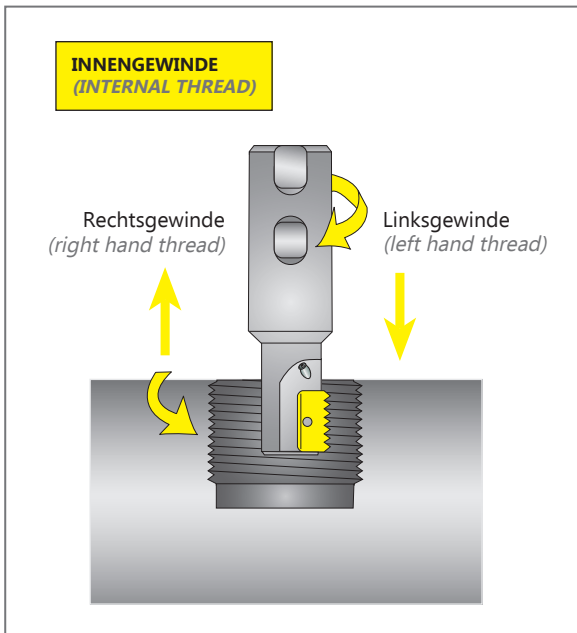
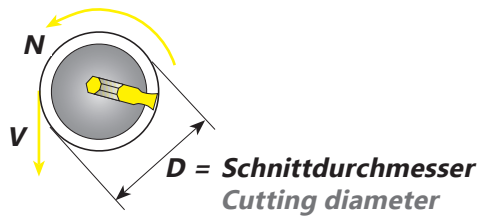

GEWINDE-FRÄSERAUSWAHL (SELECTION OF THREAD MILLS):

Für Wendepplatten- & Vollhartmetall-Gewindefräser

(For indexable and solid carbide thread mills)

Das folgende Diagramm versteht sich als ungefähre Richtlinie beim Innengewindefräsen. Das Diagramm passt für folgende Gewindearten: ISO, UN, WHIT, NPT, NPTF, BSPT, NPS, NPSF, PG.

(The following chart provides a fairly accurate visual selection tool for Internal Threading. The chart is applicable for the following thread forms: ISO, UN, WHIT, NPT, NPTF, BSPT and PG.):

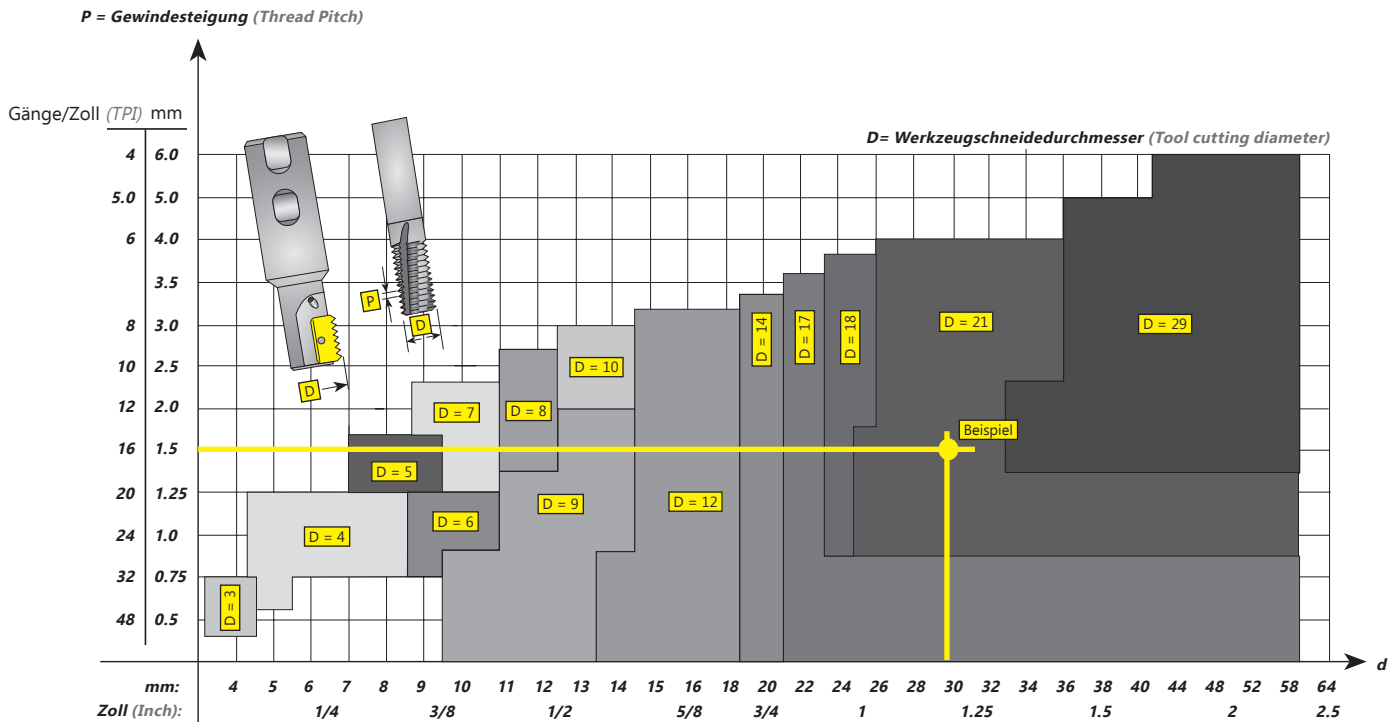

Jedes Werkzeug mit einem kleinen Schneiddurchmesser kann ein Gewinde mit großem Durchmesser herstellen.

Beispiel: Innengewinde M30 x 1.5: Sie suchen einen Fräser, der ein d=30 mm IN-RH ISO Gewinde bei einer Gewindesteigung von P= 1.5 mm herstellt. Wie aus dem Diagramm oben zu sehen ist, schneiden sich die beiden gelben Linien bei dem gewählten Werkzeug mit Schnittdurchmesser D= 21 mm

(Any tool with a small cutting diameter can produce larger diameter threads.)

Example: Internal thread M30 x 1.5: Find a Milling Tool to produce d=30 Internal right hand ISO thread with a thread pitch P=1.5 mm. As can be seen from the chart above, the two yellow lines intersect at the selected tool with a cutting diameter D=21 mm):

Gewählter Halter (Chosen toolholder): TMH21-21H
Fräsplatte (Threading insert): 21IN1.5ISOTiAlN

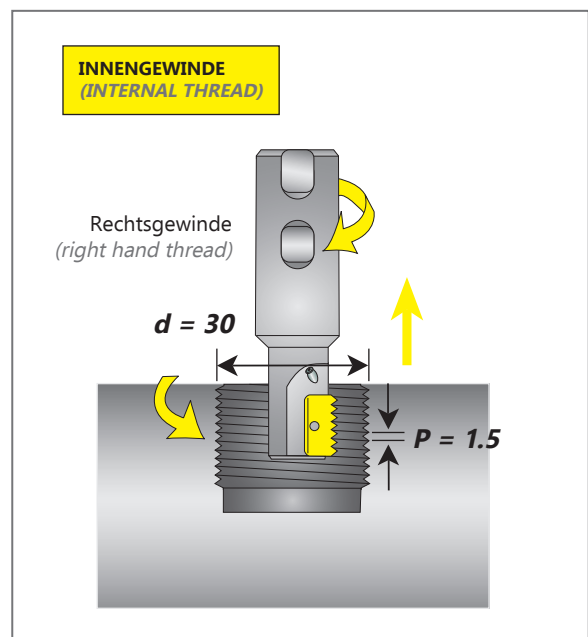

GEWINDEFRÄSPLATTEN SCHNITTGESCHWINDIGKEIT UND VORSCHUB AUSWAHL (THREAD MILLING INSERTS SPEED AND FEED SELECTION):

Ultra-Feinstkorn-Qualität mit TiAlN-Mehrfachbeschichtung (ISO K10-K20), bei mittlerer bis hoher Schnittgeschwindigkeit einzusetzen, generell für alle Werkstoffe.

(Ultra-fine grain carbide grade with multi-layer Titanium Aluminum Nitride coating (ISO K10 - K20). This is a general purpose grade, which can be used for all materials; it should be run at medium to high cutting speeds.)

ISO	Material	Vc (m/min)
P	Niedrig - & Mittel-Legierter Kohlenstoffstahl <i>Low and Medium Carbon Steels</i>	280 - 115
	Hoch-Legierter Kohlenstoffstahl <i>High Carbon Steels</i>	200 - 130
	Legierter Stahl, Vergütungsstahl <i>Alloy Steels, Treated Steels</i>	105 - 180
M	Rostfreier Stahl, rostfreier Stahlguss <i>Stainless Steels, Stainless cast steels</i>	130 - 190
	Stahlguss <i>Cast Steels</i>	150 - 190
K	Gusseisen <i>Cast Iron</i>	80 - 70
N	NE-Metalle und Aluminium <i>Non-Ferrous & Aluminum</i>	180 - 340
	Synthetics, Duroplaste, Thermoplaste <i>Synthetics, Duroplastics, Thermoplastics</i>	115 - 460
S	Nickellegierungen, Titanlegierungen <i>Nickel Alloys, Titanium Alloys</i>	25 - 90

Empfohlene Vorschubrate (*Recommended Feed Rate*): 0.05 - 0.15 mm

Wie Sie sehen, wird die Schnittgeschwindigkeit in einem Toleranzbereich gezeigt. In den meisten Fällen empfiehlt es sich, für den Anfang einen Mittelwert zu wählen. Für gehärtete Stähle die Schnittgeschwindigkeit reduzieren. Die Umrechnung von Schnittgeschwindigkeit in Drehgeschwindigkeit.

(As you may note, cutting speed is shown as a range. In most standard cases speed in the middle of the range would be the first choice for a start. For hardened steels reduce cutting speed):

AUSWAHL SCHNITTGESCHWINDIGKEIT (CUTTING SPEED SELECTION):

TMC TYP (TYPE)

Ultra-Feinstkorn-Qualität mit TiAlN-Mehrfachbeschichtung (ISO K10-K20), bei mittlerer bis hoher Schnittgeschwindigkeit einzusetzen, generell für alle Werkstoffe.

(Ultra-fine grain carbide grade with multi-layer Titanium Aluminum Nitride coating (ISO K10 - K20). This is a general purpose grade, which can be used for all materials; it should be run at medium to high cutting speeds.)

ISO	Material	Vc (Cutting Speed) (m/min)	Vorschub mm/Zahn (Feed mm/tooth) Schnittdurchmesser (Cutting Diameter)										
			ø2	ø3	ø4	ø6	ø8	ø10	ø12	ø14	ø16	ø20	ø25
P	Niedrig- & Mittel-Legierter Kohlenstoffstahl <0.55%C <i>Low and Medium Carbon Steels <0.55%C</i>	90-200	0.03	0.04	0.04	0.06	0.07	0.08	0.09	0.11	0.12	0.15	0.18
	Hoch-Legierter Kohlenstoffstahl ≥0.55%C <i>High Carbon Steels ≥0.55%C</i>	100-145	0.02	0.03	0.03	0.05	0.06	0.07	0.08	0.09	0.10	0.12	0.15
	Legierter Stahl, Vergütungsstahl <i>Alloy Steels, Treated Steels</i>												
M	Rostfreier Stahl, ferritisch <i>Stainless Steels - Ferritic</i>	55-130	0.02	0.03	0.03	0.04	0.05	0.06	0.06	0.07	0.08	0.09	0.11
	Rostfreier Stahl, austenitisch <i>Stainless Steels - Austenitic</i>												
	Stahlguss <i>Cast Steels</i>	120-135	0.02	0.02	0.03	0.03	0.04	0.05	0.05	0.06	0.07	0.08	0.10
K	Grauguss, Gusseisen mit Kupelgraphit, Temperguss <i>Cast Iron, modular cast iron, malleable iron</i>	65-120	0.03	0.04	0.04	0.06	0.07	0.08	0.09	0.11	0.12	0.15	0.18
N	Aluminium ≤12%Si, Kupfer <i>Aluminum ≤12%Si, Copper</i>	135-280	0.03	0.04	0.04	0.06	0.07	0.08	0.09	0.11	0.12	0.15	0.18
	Aluminium >12% Si <i>Aluminum >12% Si</i>	90-200	0.02	0.02	0.03	0.03	0.04	0.05	0.05	0.06	0.07	0.08	0.10
	Kunststoff, Bronze, Messing <i>Plastic, Bronze, Brass</i>	90-320	0.05	0.06	0.07	0.08	0.10	0.11	0.12	0.14	0.15	0.18	0.22
S	Nickellegierung, Titanlegierung <i>Nickel Alloys, Titanium Alloys</i>												

Für Fräser mit langer Schneide ist die Vorschubrate auf 40% zu reduzieren.
(For cutters with long cutting length reduce feed rate by 40%)

TMCC, TMCF TYP (TYPE)

ISO	Material	Vc (Cutting Speed) (m/min)	Vorschub mm/Zahn (Feed mm/tooth) Schnittdurchmesser (Cutting Diameter)										
			ø2	ø3	ø4	ø6	ø8	ø10	ø12	ø14	ø16	ø20	ø25
P	Niedrig- & Mittel-Legierter Kohlenstoffstahl <0.55%C <i>Low and Medium Carbon Steels <0.55%C</i>	100-250	0.03	0.04	0.04	0.06	0.07	0.08	0.09	0.11	0.12	0.15	0.18
	Hoch-Legierter Kohlenstoffstahl ≥0.55%C <i>High Carbon Steels ≥0.55%C</i>	110-180	0.02	0.03	0.03	0.05	0.06	0.07	0.08	0.09	0.10	0.12	0.15
	Legierter Stahl, Vergütungsstahl <i>Alloy Steels, Treated Steels</i>	90-60	0.02	0.02	0.03	0.03	0.04	0.05	0.05	0.06	0.07	0.08	0.10
M	Rostfreier Stahl, ferritisch <i>Stainless Steels - Ferritic</i>	60-160	0.02	0.03	0.03	0.04	0.05	0.06	0.06	0.07	0.08	0.09	0.11
	Rostfreier Stahl, austenitisch <i>Stainless Steels - Austenitic</i>	60-120	0.02	0.02	0.03	0.03	0.04	0.05	0.05	0.06	0.07	0.08	0.10
	Stahlguss <i>Cast Steels</i>	130-170	0.02	0.02	0.03	0.03	0.04	0.05	0.05	0.06	0.07	0.08	0.10
K	Grauguss, Gusseisen mit Kupelgraphit, Temperguss <i>Cast Iron, modular cast iron, malleable iron</i>	70-150	0.03	0.04	0.04	0.06	0.07	0.08	0.09	0.11	0.12	0.15	0.18
N	Aluminium ≤12%Si, Kupfer <i>Aluminum ≤12%Si, Copper</i>	150-350	0.03	0.04	0.04	0.06	0.07	0.08	0.09	0.11	0.12	0.15	0.18
	Aluminium >12% Si <i>Aluminum >12% Si</i>	100-250	0.02	0.02	0.03	0.03	0.04	0.05	0.05	0.06	0.07	0.08	0.10
	Kunststoff, Bronze, Messing <i>Plastic, Bronze, Brass</i>	100-400	0.05	0.06	0.07	0.08	0.10	0.11	0.12	0.13	0.15	0.18	0.22
S	Nickellegierung, Titanlegierung <i>Nickel Alloys, Titanium Alloys</i>	20-80	0.02	0.02	0.02	0.03	0.03	0.03	0.03	0.04	0.04	0.04	0.05

Für Fräser mit langer Schneide ist die Vorschubrate auf 40% zu reduzieren.
(For cutters with long cutting length reduce feed rate by 40%)

TMCL TYP (TYPE)

VHM-Gewindefräser mit abgesetztem Schaft und Innenkühlung zum Fräsen von mittleren und tiefen Bohrungen.

(Solid carbide Thread mills with relieved neck and internal coolant for milling of medium to deep bores)

- Herstellung von Gewinden die bis zum Grund gefräst werden müssen
- *Machining of threads that should be milled to the bottom*
- Zur Herstellung von Gewinden in mittleren und tiefen Bohrungen
- *For machining of threads in medium and deep bores*

VORTEILE

- Bietet eine hohe Steifigkeit und Stabilität (Vibrationsarm)
- Auch tiefe Gewinde werden in einem Durchgang hergestellt
- Geringer Schnittdruck aufgrund der verkürzten Schneide.
- Gewinde bis zu einer Länge von 3xD

ADVANTAGES:

- *Provides high rigidity and stability (anti-vibration).*
- *Accomplishes deep threads in one pass*
- *Relatively low cutting forces due to short cutting length*
- *Threads length up to 3xD.*

Ultra-Feinstkorn-Qualität mit TiAlN-Mehrfachbeschichtung (ISO K10-K20), bei mittlerer und hoher Schnittgeschwindigkeit einsetzbar, generell für alle Werkstoffe.

(Ultra-fine grain carbide grade with multi-layer Titanium Aluminum Nitride coating (ISO K10 - K20). This is a general purpose grade, which can be used for all materials; it should be run at medium to high cutting speeds.)

ISO	Material	Vc (Cutting Speed) (m/min)	Vorschub mm/Zahn (Feed mm/tooth) Schnittdurchmesser (Cutting Diameter)					
			ø10	ø12	ø14	ø16	ø20	ø25
P	Niedrig- & Mittel-Legierter Kohlenstoffstahl <0.55%C <i>Low and Medium Carbon Steels <0.55%C</i>	100 - 250	0.06	0.07	0.07	0.08	0.10	0.12
	Hoch-Legierter Kohlenstoffstahl ≥0.55%C <i>High Carbon Steels ≥0.55%C</i>	110 - 180	0.05	0.05	0.06	0.07	0.09	0.10
	Legierter Stahl, Vergütungsstahl <i>Alloy Steels, Treated Steels</i>	90 - 160	0.03	0.04	0.04	0.05	0.06	0.07
M	Rostfreier Stahl, ferritisch <i>Stainless Steels - Ferritic</i>	60 - 160	0.04	0.04	0.05	0.06	0.06	0.08
	Rostfreier Stahl, austenitisch <i>Stainless Steels - Austenitic</i>	60 - 120	0.04	0.04	0.04	0.05	0.06	0.07
	Stahlguss <i>Cast Steels</i>	130 - 170	0.03	0.04	0.04	0.05	0.06	0.07
K	Grauguss, Gusseisen mit Kupelgraphit, Temperguss <i>Cast Iron, modular cast iron, malleable iron</i>	70 - 150	0.06	0.07	0.07	0.08	0.10	0.12
N	Aluminium ≤12%Si, Kupfer <i>Aluminum ≤12%Si, Copper</i>	150 - 350	0.06	0.07	0.07	0.08	0.10	0.12
	Aluminium >12% Si <i>Aluminum >12% Si</i>	100 - 250	0.03	0.04	0.04	0.05	0.06	0.07
	Kunststoff, Bronze, Messing <i>Nickel Alloys, Titanium Alloys</i>	100 - 400	0.08	0.09	0.10	0.11	0.13	0.15
S	Nickellegierung, Titanlegierung <i>Nickel Alloys, Titanium Alloys</i>	20 - 80	0.02	0.02	0.02	0.03	0.03	0.03

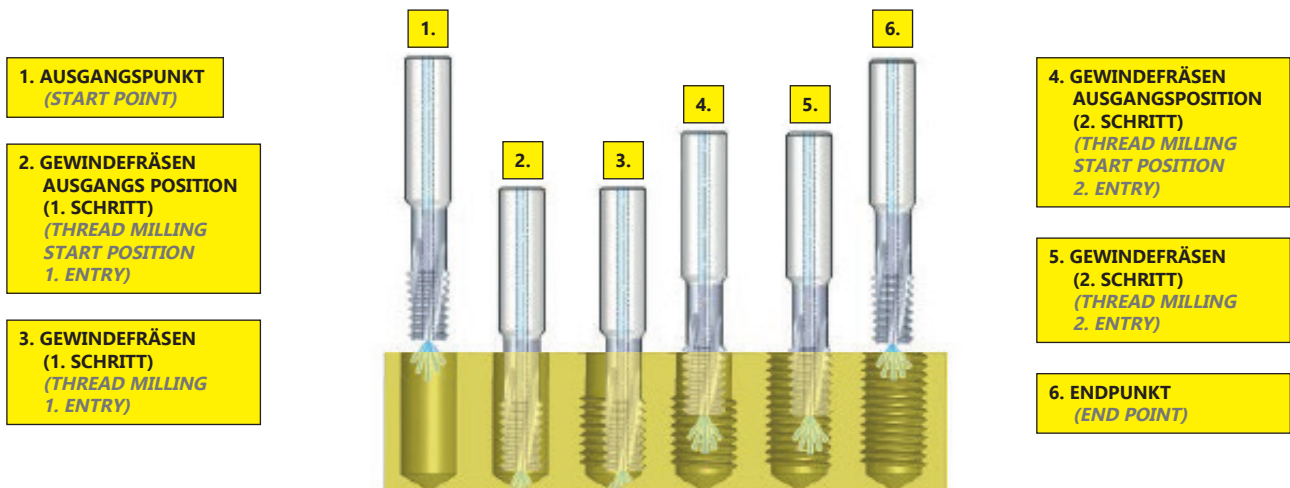

MINI-GEWINDEFÄSER TMCM UND TMCM I TYPEN (MINI THREAD MILLING TMCM AND TMCM I TYPES):

Ultra-Feinstkorn-Qualität mit TiAlN-Mehrfachbeschichtung (ISO K10-K20), bei mittlerer und hoher Schnittgeschwindigkeit einsetzbar, generell für alle Werkstoffe.

(Ultra-fine grain carbide grade with multi-layer Titanium Aluminum Nitride coating (ISO K10 - K20). This is a general purpose grade, which can be used for all materials; it should be run at medium to high cutting speeds.)

Feinstkorn Hartmetall mit einer Aluminium-Titan-Nitrid Mehrlagenbeschichtung (ISO K10-K20). Sehr hohe Temperaturbeständigkeit und weiche Schnitte für hohe Schnittgeschwindigkeiten garantieren beste Standzeiten. Generell für alle Regel und Feingewinde einsetzbar.

(Ultra-fine grain carbide grade with multi-layer Titanium Aluminum Nitride coating (ISO K10 - K20). Extremely high heat resistant and smooth cutting operation, for high performance, and normal machining conditions. General purpose for all materials.)

MT11 Ultra-Feinstkorn-Hartmetall mit PVD-Dreilagenschichtung.

(Ultra-fine grain grade with advanced triple PVD coating.)

ISO	Material	Vc (Cutting Speed) (m/min)	Vorschub mm/Zahn (Feed mm/tooth) Schnittdurchmesser (Cutting Diameter)													
			ø2	ø1.5	ø2	ø3	ø4	ø5	ø6	ø7	ø8	ø9	ø10	ø12	ø14	ø16
P	Niedrig- & Mittel-Legierter Kohlenstoffstahl <0.55%C <i>Low and Medium Carbon Steels <0.55%C</i>	60-120	0.04	0.05	0.05	0.07	0.09	0.11	0.13	0.14	0.15	0.16	0.16	0.17	0.18	0.18
	Hoch-Legierter Kohlenstoffstahl ≥0.55%C <i>High Carbon Steels ≥0.55%C</i>	60- 90	0.03	0.04	0.05	0.06	0.08	0.09	0.10	0.12	0.13	0.14	0.14	0.16	0.17	0.18
	Legierter Stahl, Vergütungsstahl <i>Alloy Steels, Treated Steels</i>	50- 80	0.03	0.04	0.04	0.05	0.05	0.06	0.07	0.07	0.08	0.09	0.10	0.12	0.13	0.14
M	Rostfreier Stahl, ferritisch <i>Stainless Steels - Ferritic</i>	70-100	0.02	0.03	0.03	0.04	0.05	0.06	0.06	0.07	0.08	0.09	0.10	0.11	0.12	0.13
	Rostfreier Stahl, austenitisch <i>Stainless Steels - Austenitic</i>	60- 90	0.02	0.03	0.03	0.04	0.05	0.06	0.06	0.07	0.08	0.09	0.10	0.11	0.12	0.13
	Stahlguss <i>Cast Steels</i>	70- 90	0.03	0.04	0.04	0.05	0.05	0.06	0.07	0.07	0.08	0.09	0.10	0.12	0.13	0.14
K	Grauguss, Gusseisen mit Kupelgraphit, Temperguss <i>Cast Iron, modular cast iron, malleable iron</i>	40- 80	0.04	0.05	0.05	0.07	0.09	0.11	0.13	0.14	0.15	0.16	0.16	0.17	0.18	0.18
N	Aluminium ≤12%Si, Kupfer <i>Aluminum ≤12%Si, Copper</i>	100-200	0.04	0.05	0.05	0.07	0.09	0.11	0.13	0.14	0.15	0.16	0.16	0.17	0.18	0.18
	Aluminium >12% Si <i>Aluminum >12% Si</i>	60-140	0.03	0.03	0.03	0.04	0.05	0.06	0.06	0.07	0.08	0.09	0.10	0.11	0.13	0.14
	Kunststoff, Bronze, Messing <i>Nickel Alloys, Titanium Alloys</i>	50-200	0.09	0.10	0.11	0.12	0.14	0.16	0.18	0.19	0.19	0.19	0.19	0.19	0.20	0.20
S	Nickellegierung, Titanlegierung <i>Nickel Alloys, Titanium Alloys</i>	20- 40	0.03	0.03	0.03	0.04	0.04	0.05	0.06	0.06	0.06	0.07	0.07	0.07	0.08	0.08

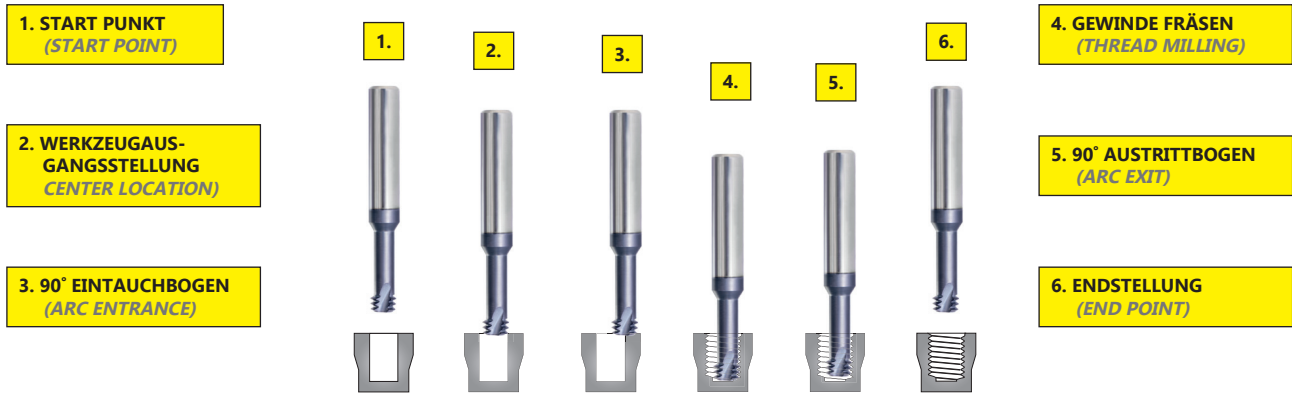

Vergleichstabelle Mini-Fräser - Gewindebohrer | *Mini Thread mills vs. Taps*

Eigenschaft (Property)	Vollhartmetall-Gewindefräser (solid carbide thread mill)	Gewindebohrer (Tap)
Oberflächengüte (Thread surface quality)	Hoch (High)	Mittel (Medium)
Gewindegeometrie (Thread geometry)	Sehr exakt (Very accurate)	Mittel (Medium)
Gewindetoleranz (Thread tolerances)	4h, 5h, 6h, mit Standardfräser (4h, 5h, 6h with a standard cutter)	6h mit Standardbohrer, 4h mit Spezialbohrer (6h with standard tap, 4h with a special tap)
Bearbeitungszeit (Machining time)	Schneller als der Gewindebohrer (Same as tap or shorter)	Schnell (Short)
Antriebsleistung (Machining load)	Sehr gering (Very small)	Hoch (High)
Werkzeugbruch (Tool breakage)	Nahezu unmöglich (Almost impossible)	Öfter möglich (frequent)
Fräsdurchmesser Reichweite (Range of thread diameters)	Der gleiche Fräser für verschiedene Fräsdurchmesser mit der gleichen Steigung (The same thread for wide range of diameters with the same pitch)	Spezieller Gewindebohrer notwendig (Specific tap for each diameter)
Rechts oder Linksgewinde (Right/Left hand threading)	Gleicher Fräser für beide Gewinde (Same cutter for both threads)	Spezielle Gewindebohrer notwendig (Specific tap required)
Profil (Profile)	Vollprofil (Full profile)	Teilprofil (Partial profile)

MINI-GEWINDEFÄSER TMCMH TYP (MINI THREAD MILLS TMCMH TYPES):

Ultra-Feinstkorn Hartmetall mit einer speziellen PVD-dreifach-Beschichtung.
(Sub-Micron Grade with advanced triple PVD coating)

Linkslaufende Spindeldrehrichtung code M04 | For left hand spindle rotation use code M04

ISO	Material	Härte (Hardness) (HRc)	Vc (Cutting Speed) (m/min)	Vorschub mm/Zahn (Feed mm/tooth) Schnittdurchmesser (Cutting Diameter)															
				ø1	ø1.5	ø2	ø3	ø4	ø5	ø6	ø7	ø8	ø9	ø10	ø12	ø14	ø16		
S	Nickellegierung, Titanlegierung <i>Nickel Alloys, Titanium Alloys</i>		20-40	0.03	0.03	0.03	0.04	0.04	0.05	0.06	0.06	0.06	0.07	0.07	0.07	0.08	0.08		
H	Gehärteter Stahl <i>Hardened Steels</i>	45-50	60-70	0.03	0.04	0.04	0.05	0.05	0.06	0.06	0.07	0.07	0.08	0.08	0.09	0.10	0.11		
		51-55	50-60	0.02	0.03	0.03	0.04	0.04	0.05	0.05	0.06	0.06	0.07	0.07	0.08	0.09	0.10		
		56-62	40-50	0.01	0.02	0.02	0.03	0.03	0.04	0.04	0.05	0.05	0.06	0.06	0.07	0.08	0.09		

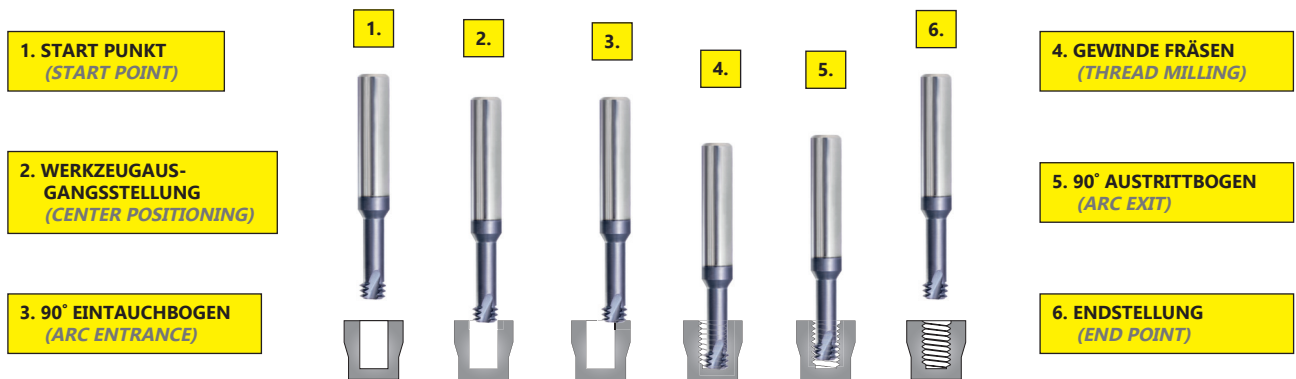

Bearbeitungsbeispiel (Machining example)	
Anwendung (Application)	Innengewinde M4 X 0.7 (Internal Thread M4 X 0.7)
Gewindetiefe (Thread Depth)	8.0 mm
Materialart (Type of Material)	Werkzeugstahl: D2 (Tool Steel: D2)
Härte (Hardness)	60-62 (HRc)
Werkzeug (Tools designation)	TMCMH06031-3-9-0.7ISO
Schnittwerte (Machining parameters)	Schnittgeschwindigkeit: 44 m/min Vorschub: 0,03 pro Zahn (Cutting Speed: 44 m/min Feed: 0.03 mm/tooth)
Maschine (Machine)	Mori Seiki NV5000
Steuerung (Control)	Fanuc
Kühlmittel (Coolant)	Emulsion
Standzeit (Tool Life)	84 Teile

13

MINI SENKWERKZEUGE MINI CHAMFERING TOOLS

Feinstkorn Hartmetall mit einer Aluminium-Titan-Nitrid Mehrlagenbeschichtung (ISO K10-K20). Sehr hohe Temperaturbeständigkeit und weiche Schnitte für hohe Schnittgeschwindigkeiten garantieren beste Standzeiten.

Fine grain carbide grade with multi-layer Titanium Aluminum Nitride coating (ISO K10 - K20). Very high resistance and smooth cutting at high speed guarantee the best tool life. For general machining of regular and fine threads.

VORTEILE

- besonders zum Fräsen, Entgraten und Rückwärtssenken
- doppelseitig schneidend
- spiralgenutet für weichen Schnitt

ADVANTAGES:

- *optimal for deburring, back chamfering and milling*
- *double side cutting*
- *Spiral flutes allow smooth cutting*

THREAD MILLING

PRODUKT BEZEICHNUNG | PRODUCT DESIGNATION

BEISPIEL | EXAMPLE: CHT0315-3-3-A45

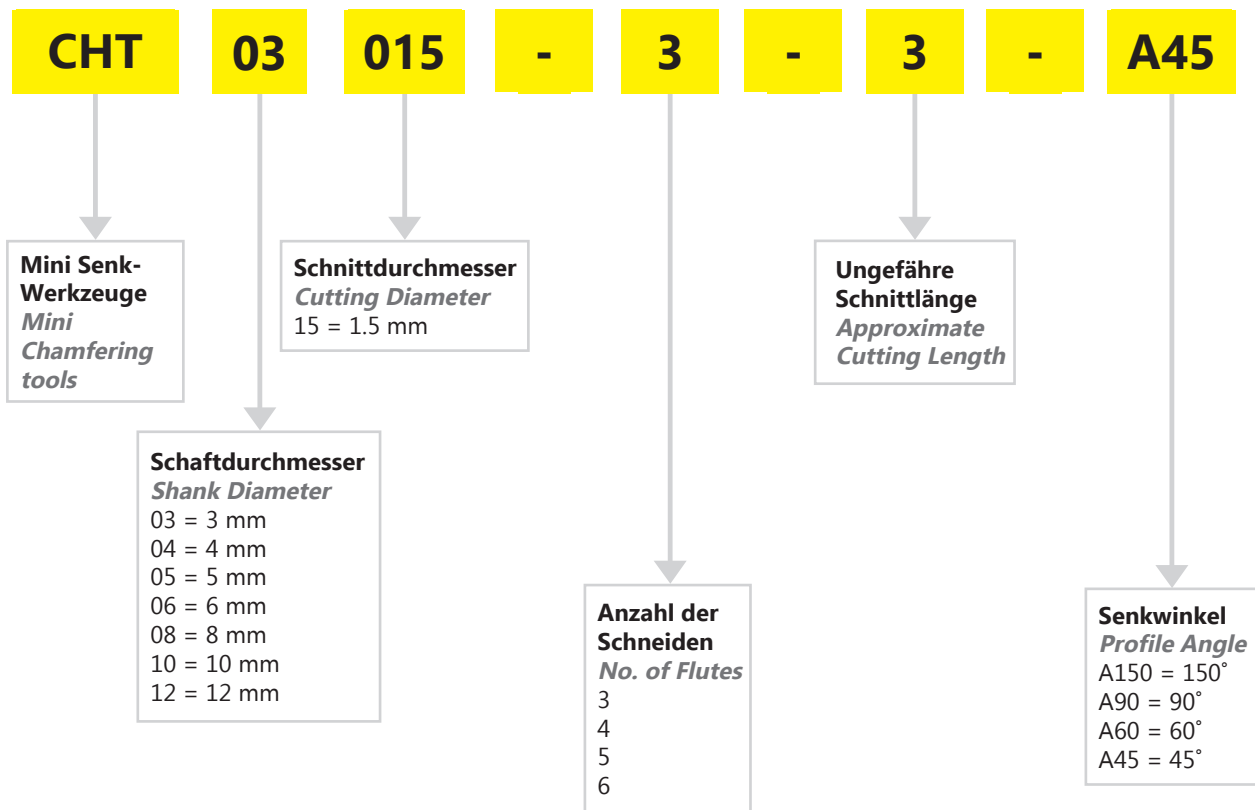

MINI SENK-WERKZEUGE | MINI CHAMFERING TOOLS

TiAlN beschichtet
TiAlN coated

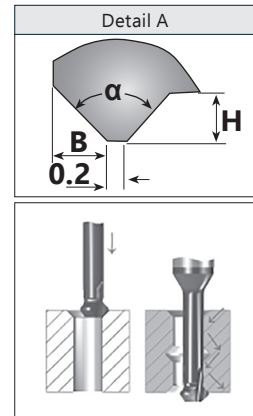
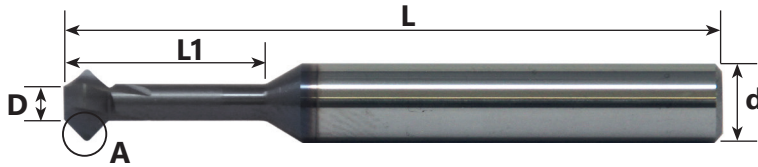

90°

Artikelnummer (Item Number)	d	D	L1	H	B	α	Anzahl der Schneiden (No. of Flutes)	L
CHT03015-3-3-A90	3	1.5	3.8	3.8	0.4	90°	3	39
CHT0302-3-5-A90	3	2.0	5.0	5.0	0.5	90°	3	39
CHT03025-3-6-A90	3	2.5	6.3	6.3	0.6	90°	3	39
CHT0303-3-7-A90	3	3.0	7.5	7.5	0.7	90°	3	39
CHT04035-3-9-A90	4	3.5	8.8	8.8	0.8	90°	3	51
CHT0404-3-10-A90	4	4.0	10.0	10.0	0.9	90°	3	51
CHT05045-3-11-A90	5	4.5	11.3	11.3	1.1	90°	3	51
CHT0505-3-12-A90	5	5.0	12.5	12.5	1.2	90°	3	51
CHT06055-3-13-A90	6	5.5	13.8	13.8	1.3	90°	3	51
CHT0606-3-15-A90	6	6.0	15.0	15.0	1.6	90°	3	51

Für große Auskräglängen 90° | Long Reach 90°

Artikelnummer (Item Number)	d	D	L1	H	B	α	Anzahl der Schneiden (No. of Flutes)	L
CHT0303-3-12-A90	d3	3.0	12.0	0.6	0.7	90°	3	39
CHT04035-3-14-A90	4	3.5	14.0	0.7	0.8	90°	3	51
CHT0404-3-16-A90	4	4.0	16.0	0.8	0.9	90°	3	51
CHT0404-3-16-LA90	4	4.0	16.0	0.8	0.9	90°	3	105
CHT05045-3-18-A90	5	4.5	18.0	1.0	1.1	90°	3	51
CHT0505-3-20-A90	5	5.0	20.0	1.1	1.2	90°	3	51
CHT0505-3-20-LA90	5	5.0	20.0	1.1	1.2	90°	3	105
CHT06055-3-22-A90	6	5.5	22.0	1.2	1.3	90°	3	58
CHT0606-3-24-A90	6	6.0	24.0	1.5	1.6	90°	3	58
CHT0606-3-24-LA90	6	6.0	24.0	1.5	1.6	90°	3	105
CHT0808-4-28-A90	8	8.0	28.0	1.6	1.7	90°	4	64
CHT0808-4-28-LA90	8	8.0	28.0	1.6	1.7	90°	4	105
CHT1010-5-35-A90	10	10.0	35.0	1.8	1.9	90°	5	73
CHT1212-6-42-A90	12	12.0	42.0	2.1	2.2	90°	6	84

60°

Artikelnummer (Item Number)	d	D	L1	H	B	α	Anzahl der Schneiden (No. of Flutes)	L
CHT0302-3-5-A60	3	2.0	5.0	0.4	0.3	60°	3	39
CHT0303-3-7-A60	3	3.0	7.5	0.6	0.3	60°	3	39
CHT04035-3-9-A60	4	3.5	8.8	0.7	0.5	60°	3	51
CHT0404-3-10-A60	4	4.0	10.0	0.8	0.5	60°	3	51
CHT05045-3-11-A60	5	4.5	11.3	1.0	0.6	60°	3	51
CHT0505-3-12-A60	5	5.0	12.5	1.1	0.7	60°	3	51

14

LEHRRINGE/LEHRDORNE
RING GAUGES/PLUG GAUGES

*SONDER LEHRRINGE LEHRDORNE AUF ANFRAGE
RING GAUGES PLUG GAUGES*





VHM SCHWARZ GmbH

Lilienthalstr. 3

70825 Korntal-Münchingen, Germany

Tel.: +49 (0) 711/51 87 88 10

Fax: + 49 (0) 711/51 87 88 06

www.vhm-schwarz.com

info@vhm-schwarz.com